

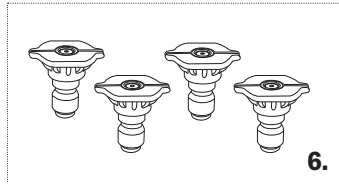

PRESSURE WASHER BREAKDOWN

PE-2565HWAGENSP



2.

1.

3.

4.

REF #	DESCRIPTION	PART #
1	Frame	85.600.116
2	Engine - Honda GX200	Not For Resale
3	Pump - TP2530J34	85.139.020SP
4	Wheel	85.660.004BF
5	Soap Hose	85.400.005
6	Nozzle Set	85.210.035
7	Gun & Wand	85.205.026
8	Hose 50' x 3/8"	85.238.153

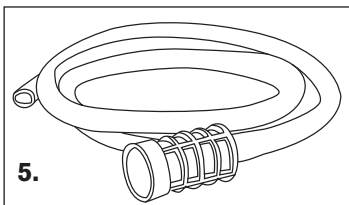

5.

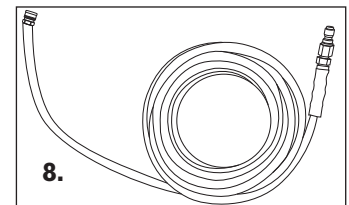

8.

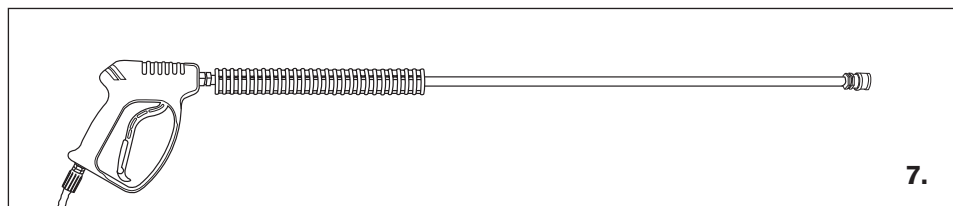

7.



PRESSURE WASHER BREAKDOWN

PE-2565HWAGENSP

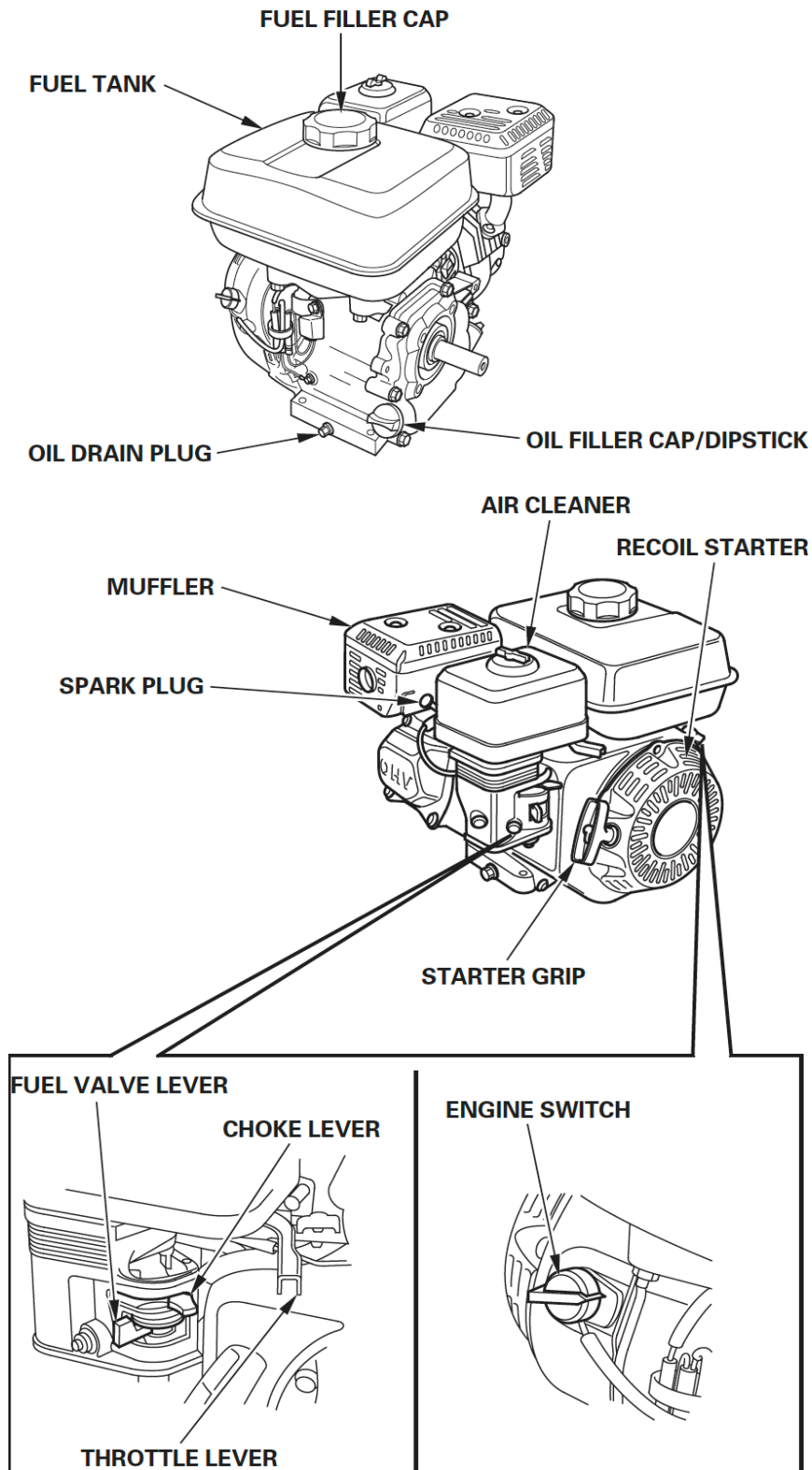



PRESSURE WASHER BREAKDOWN

PE-2565HWAGENSP

GENERAL PUMP A member of the Interpump Group

TP Series 51, J34

Triplex Plunger Pump, SAE J609 Flange

FEATURES

- Forged brass manifold with exclusive lifetime warranty
- New, over-sized connecting rods for ultimate crankcase performance
- Die cast, anodized aluminum, oil-bath crankcase
- Solid ceramic plungers with continuously lubricated packings
- The original Interpump unitized, stainless steel, K123 inlet and outlet valves
- Ideal for all general cleaning applications
- Comes standard with either SAE J609 gasoline engine mounting flange, or NEMA 56C mounting flange.*
- Also available in "L" left-handed versions



SPECIFICATIONS

Pump Model	TP2520J34	TP2526J34	TP2530J34	TP2533J34
Maximum Volume	1.9 GPM	2.6 GPM	2.88 GPM	3.3 GPM
Maximum Discharge Pressure	2500 PSI			
Rated Pump Speed	3400 RPM			
Maximum Inlet Pressure	125 PSI			
Maximum Inlet Vacuum	3 ft. water (2.6 in. Hg)			
Bore	.591 in. / 15 mm			
Stroke (in. / mm)	.197 / 5	.260 / 6.6	.283 / 7.2	.315 / 8
Crankcase Oil Capacity	11.0 oz.			
Maximum Fluid Temperature	165°F			
Inlet Port Thread	3/8-19 BSPP-F			
Discharge Port Thread	1/4-19 BSPP-F			
Hollow Shaft I.D.	3/4 in. / 19 mm			
Weight	11.4 lbs.			
Dimensions	7.0 x 7.2 x 5.5 in.			

DIMENSIONAL DRAWING

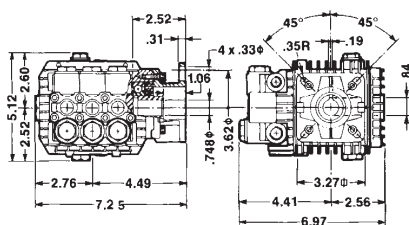

J34 Version

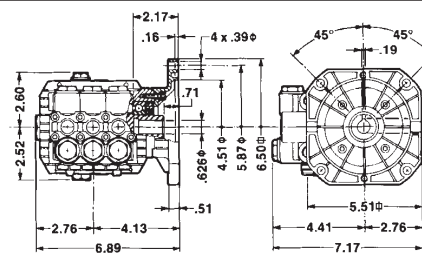

X34 Version





PRESSURE WASHER BREAKDOWN

PE-2565HWAGENSP

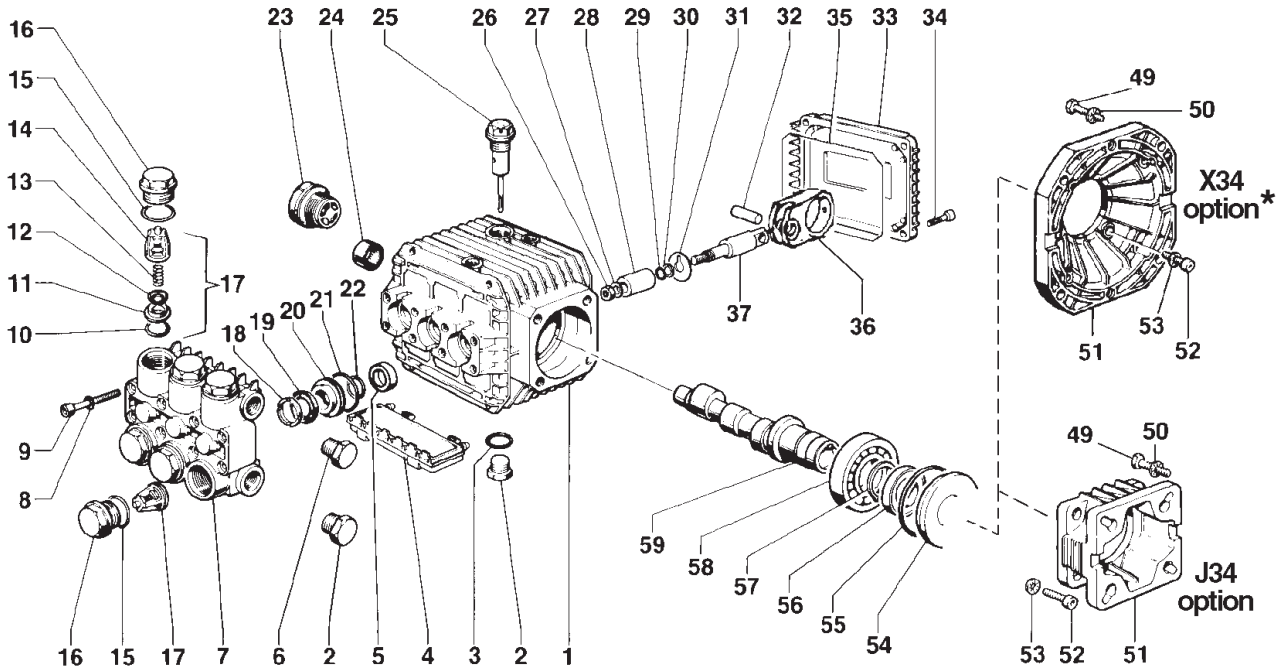

*To reduce time and save money in assembling GP pumps to gasoline engines, General Pump recommends that you purchase the TP2530X34 pump with a GP #640042, J609-to-56C Adapter Flange and GP #100320 Bolt Kit.

PARTS LIST

ITEM	PART NO.	DESCRIPTION	KIT NO.	QTY.	ITEM	PART NO.	DESCRIPTION	KIT NO.	QTY.	ITEM	PART NO.	DESCRIPTION	KIT NO.	QTY.
1.	51.0106.22	Crankcase		1	19.	90.2620.00	Packing	96,97	3	37.	51.0500.56	Plunger Rod		3
2.	98.2100.00	Plug		2	20.	51.0800.70	Packing Retainer	86,96	3	49.	99.2730.00	Screw, X34		4
3.	90.3833.00	O-Ring		1	21.	90.3604.00	O-Ring	86,96,97	3		99.3345.00	Screw, X34		
4.	51.2091.02	Protector		1	22.	90.3835.00	O-Ring	86,96,97	3	50.	96.7014.00	Washer, J34		4
5.	90.1565.00	Oil Seal	83	3	23.	97.5968.00	Sight Gauge		1		96.7104.00	Washer, X34		
6.	98.2041.00	Plug		1	24.	20.2128.35	Needle Bearing		1	51.	10.0346.22	Flange, J34		1
7.	51.1200.41	Manifold, Brass		1	25.	98.2103.00	Oil Dip Stick		1		10.0344.22	Flange, X34		
8.	96.6938.00	Washer		8	26.	92.2216.00	Nut		3	52.	99.1867.00	Screw		4
9.	99.1943.00	Screw		8	27.	96.7008.00	Washer		3	53.	96.6938.00	Washer		4
10.	90.3841.00	O-Ring	123	6	28.	51.0400.09	Plunger (15 mm)		3	54.	50.2115.51	Spacer		1
11.	36.2003.66	Valve Seat	123	6	29.	90.3572.00	O-Ring		3	55.	90.4097.00	O-Ring		1
12.	36.2001.76	Valve Plate	123	6	30.	90.5022.00	Back Up Ring		3	56.	90.1644.00	Oil Seal		1
13.	94.7376.00	Spring	123	6	31.	96.7070.00	Flinger Washer		3	57.	90.0667.00	Snap Ring		1
14.	36.2025.51	Valve Cage	123	6	32.	97.7310.00	Conn. Rod Pin		3	58.	20.2835.21	Bearing		1
15.	90.3847.00	O-Ring		6	33.	51.1600.22	Crankcase Cover		1	59.	51.0210.65	Crankshaft, TP2520		1
16.	98.2216.00	Valve Cap		6	34.	99.1867.00	Screw		4		51.0211.65	Crankshaft, TP2526		
17.	36.7115.01	Valve Assy.	123	6	35.	90.3917.00	Cover O-Ring		1		51.0221.65	Crankshaft, TP2530		
18.	51.1000.51	Head Ring	96,97	3	36.	51.0301.22	Connecting Rod		3		51.0218.65	Crankshaft, TP2533		

REPAIR KITS

KIT NO.	83	86	96	97	123
ITEM NO.s INCLUDED IN KIT	5	20, 21, 22	18, 19, 20, 21, 22	18, 19, 21, 22	10, 11, 12, 13, 14, (17)
NUMBER OF ASSEMBLIES IN KIT	3	3	1	3	6
NUMBER OF CYLINDERS KIT WILL SERVICE	3	3	1	3	3

TORQUE SPECS*

Position	Ft.-lbs.
2	29.4
6	14.7
9	8.8
16	60.0
23	13.2
26	11.0
34	7.3
49	14.7
52	7.3

*Decrease torque by 20% if threads are lubricated.