

**WESTFIELD** 



## IT'S NOT AN ORDINARY AUGER... IT'S A WESTFIELD.

When you make only one product, you get to be very good at it. For over 65 years, Westfield has developed and refined the best grain augers available. We've learned that farmers want affordable, simple, straightforward designs for labor saving performance and dependability. Through a commitment to farm proven designs and innovation, Westfield has earned a solid reputation for superior quality products. Westfield takes pride in developing the grain auger industry in order to improve the profitability and lifestyle of farmers today. Westfield's grain augers are built with the best materials, components and features to provide value and performance you can count on. This is our promise and the reason why we're the industry leader.

Westfield's WR Series is better by design, featuring Wear Edge Technology™ on critical wear points to extend the life of the flighting and powder coat paint for a strong durable finish. With more features and options than anyone else, the WR can be customized to suit any situation. The WR Series is available in 6" to 13" diameters, lengths from 26' to 71' and capacities up to 7,800 bph.

### Westfield is an Ag Growth International brand.

Ag Growth International (AGI) is a leading manufacturer of grain, feed and fertilizer handling, storage and conditioning equipment. Our brands are amongst the most recognized in the industry. The AGI product catalog includes portable handling equipment (augers, belt conveyors, grain vacs), permanent handling systems (bucket elevators, enclosed belt conveyors, chain conveyors, structural) and storage systems (aeration, drying, bins/silos) that service the grain, feed, fuel and fertilizer sectors for on-farm and commercial operations.

## THE WR SERIES FEATURES

### | WINCH

Hand winch with automatic brake is sized and geared to match the auger. The strong ¼" galvanized aircraft type cable has 7,000 lbs. break strength.



### | ROLLERTRACK SHOE

A roll-formed track under the auger tube provides excellent rigid support. Augers 46' and up have heavy-duty cable trussing for extra support and positive tube alignment.



### | GEAR BOXES

Gear boxes have forged steel gears with tapered roller bearings running in oil for years of dependable service and can be flipped for right or left hand PTO drive.



### | INTAKE

The shielded auger intake has a long, one-pin, quick-remove clevis that is easily replaced. Intake flight has welded Wear Edge™ for long life with special low pitch for proven added capacity. Greaseable bushing centers flight reducing vibration and wear.



### | FLIGHTING

Wear Edge Technology™ is added to the flighting. This means flighting is mounted and stretched on the flight shaft with hydraulic power and then welded in place for smoother running and longer life. All stretched and welded flight connections are timed for smooth grain flow.



### | DRIVESHAFT BEARINGS

Driveshaft bearings constructed of durable oil-impregnated hard-wood, for long, quiet operation can be easily replaced if needed with no disassembly of drive-shaft. Bearing brackets are factory jig-welded for precise alignment.

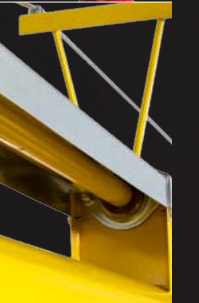

### | UNDERCARRIAGE

Undercarriages of heavy steel tubing are designed for each specific auger length for better balance and stability. Added cross bracing is used on larger models. Upper lift arms sit back from the axle and quickly tuck away for excellent bin eave clearance. Wide axles provide added stability. High speed wheels with cast iron hubs and tapered roller bearings are standard.

### | LUBRICATED UPPER DRIVE

Heavy-duty hardened steel sprockets and high speed roller chain are sized to match auger length and diameter. Lubricated upper drive extends the life of sprockets and drive chain. Standard on all models.



# DRIVE OPTIONS

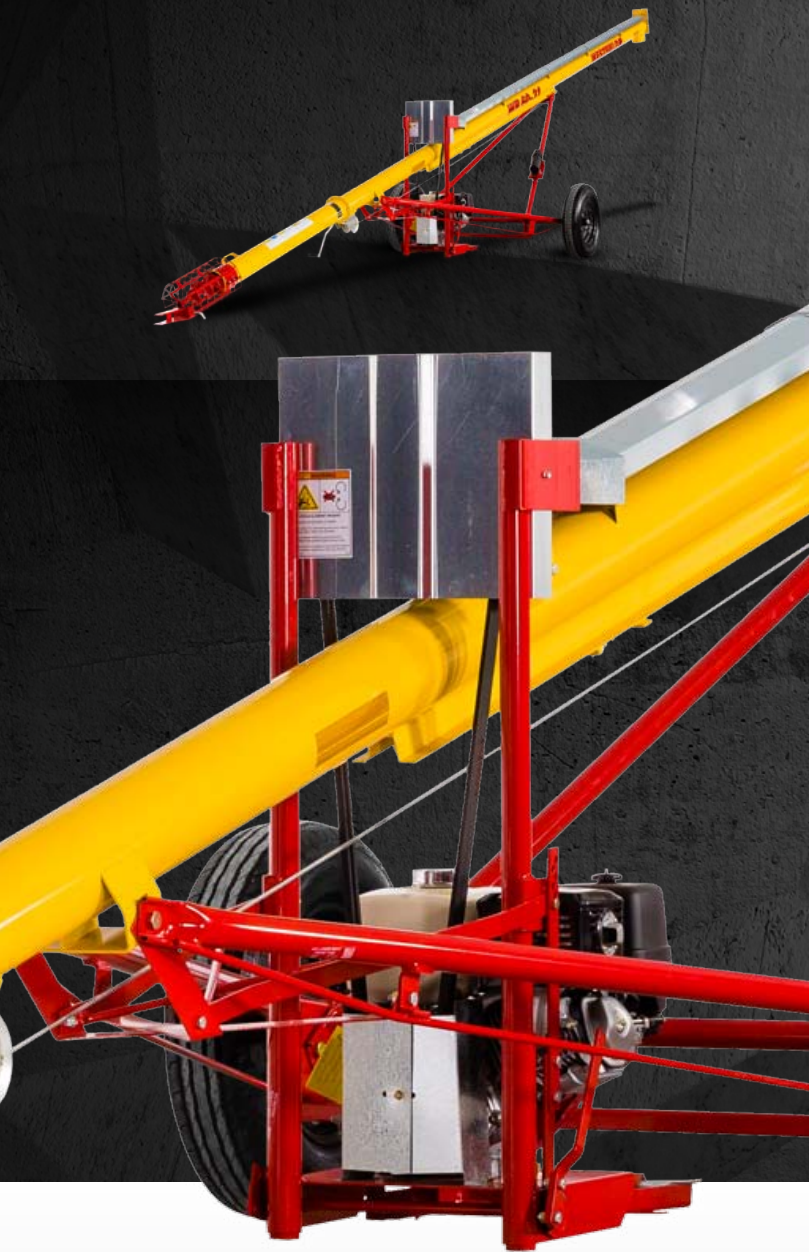

## MD

### | MOTOR DRIVE

The engine mounts crosswise for easy starting from the side of the auger. The motor mount (for either gas engine or electric motor) is self-leveling at all auger positions keeping the motor at the correct working angle. Double belt drive with adjustable tension provides better traction and can be easily replaced. The motor drive does not have any gear boxes, so there are less moving parts. This means less time and money are spent on maintenance and repairs.



## EMD

### | ELECTRIC MOTOR DRIVE

The electric motor is available for all models. The motor mounts firmly to the gear box and auger tube, keeping it in place and preventing damage. A double or triple belt drive (depending on model), provides better traction. Positive belt tension can be achieved by using the threaded adjustment, ensuring the auger is performing at maximum capacity.



## PTO-SD

### | PTO SHAFT DRIVE

The gear box is connected directly to the drive shaft and offers the convenience and flexibility of using it for left or right hand drive. The PTO-SD comes with a non-separable 60" PTO driveline that extends to 80" and includes a driveline transport saddle.

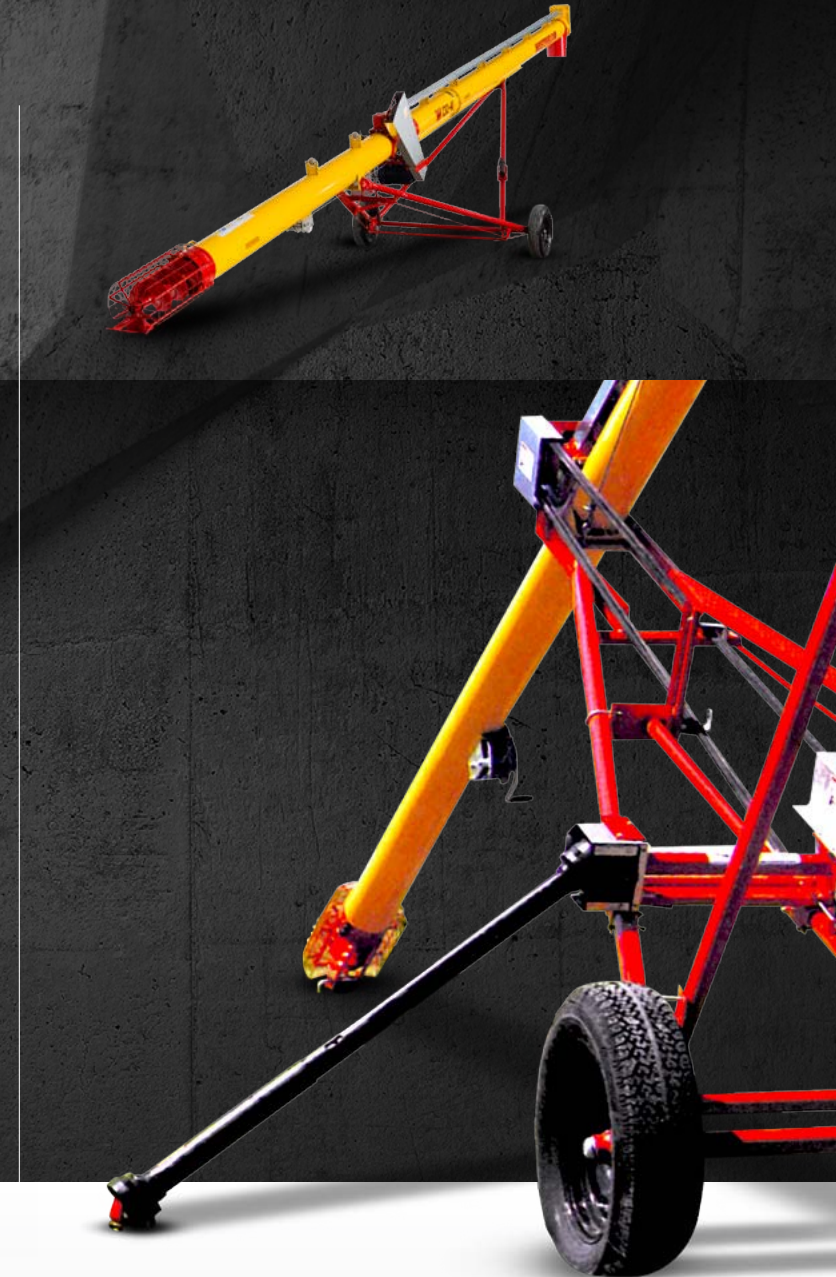

## PTO-BD

### | PTO BELT DRIVE

The belt drive runs from the gear box to the jack shaft near the auger wheels - keeping the auger intake away from the tractor. This allows for more working room and longer bin reach. The drive can be positioned to left or right hand drive and the non-separable 48" PTO can be extended to 68" and is guided by an anti-belt-whip. A driveline saddle holds the drive in place when the auger is in transport.

## ADD THESE OPTIONAL FEATURES

### HYDRAULIC WINCH

High capacity winch with automatic break allows the user to raise and lower the auger.

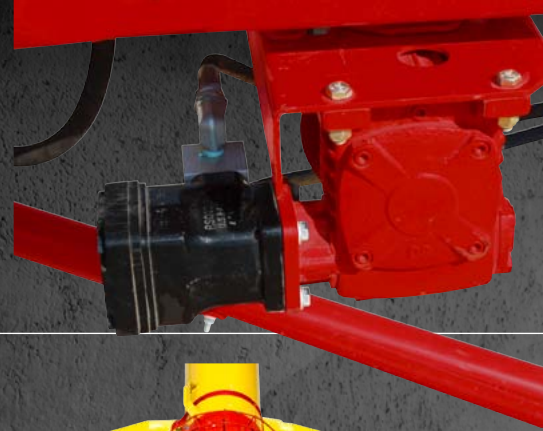

### POLY HOPPERS

Poly hoppers are durable and flexible and allow for easy grain transfer with minimum spillage.



### SPEED REDUCER KIT

The speed reducer lowers flight speed for grain dryers and feed systems and minimizes wear on the auger.



### FLEX SPOUT

With five bucket sections, the flex spout directs grain flow and reduces spillage. Available in polyethylene.

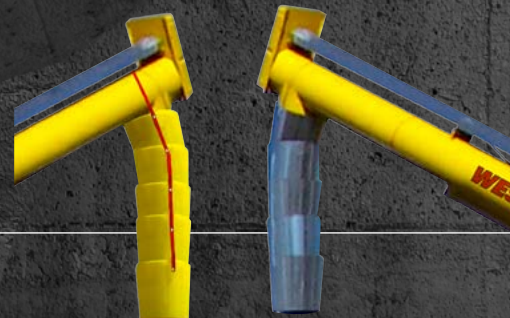

### SWIVEL ARC KITS

The Swivel Arc Kit allows the auger to move around circular bin setups.



### STEEL INTAKE HOPPERS

The self-leveling steel intake hopper has a tapered transition neck to direct grain from the hopper into the auger, removable access plate for easy clean-out, a tow hitch and stabilizer bar. Optional wheel kit available.



### WHEEL KIT

The wheel kit helps move the auger into position easily and works best when using a steel intake hopper.



# WR + W

## HEIGHT, REACH & WHEEL SPECIFICATIONS

	A	B	C	D	E	F	G	H	I	
WR	Height Lowered	Height Halfway	Height Raised	Reach Lowered	Reach Halfway	Reach Raised	Height at Liftarms	Height at Wheels	Reach to Liftarms	Wheel Thread
26'	6' 5"	12' 8"	17' 11"	10' 9"	9' 5"	7' 3"	7' 9"	11' 4"	6' 10"	68"
31'	7' 8"	15' 1"	21' 6"	13' 9"	12' 0"	9' 3"	8' 10"	12' 10"	7' 8"	70"
36'	9' 0"	17' 4"	24' 10"	16' 3"	14' 3"	11' 2"	10' 0"	14' 4"	8' 11"	82"
41'	9' 7"	20' 2"	28' 7"	18' 8"	16' 4"	12' 8"	11' 6"	16' 4"	10' 2"	88"
46'	10' 10"	22' 7"	31' 6"	20' 11"	18' 3"	14' 3"	12' 9"	18' 1"	11' 6"	88"
51'	11' 11"	25' 0"	35' 0"	23' 1"	20' 2"	15' 10"	14' 2"	19' 11"	12' 10"	94"
56'	11' 5"	26' 0"	38' 0"	25' 0"	21' 6"	16' 2"	16' 10"	23' 2"	13' 1"	112"
61'	11' 8"	28' 4"	41' 0"	27' 4"	24' 4"	19' 0"	17' 2"	24' 3"	16' 2"	112"
71'	12' 10"	33' 0"	47' 0"	31' 8"	28' 1"	22' 6"	19' 8"	27' 6"	18' 5"	118"
W										
31'	7' 7"	13' 9"	19' 3"	13'	11' 9"	9' 8"	9'	12' 5"	8'	112"
36'	7' 10"	15' 4"	22' 1"	15'	14' 2"	12' 11"	9' 6"	12' 10"	11' 1"	112"
41'	10' 0"	19' 9"	28' 3"	16' 5"	14' 5"	11' 3"	—	—	—	94"
51'	10' 9"	21' 10"	35' 5"	22' 4"	20' 2"	15' 3"	—	—	—	112"
61'	11' 7"	25' 8"	41' 1"	27' 5"	24' 10"	20' 0"	—	—	—	118"
71'	12' 11"	30' 10"	47' 0"	32' 3"	29' 5"	23' 1"	—	—	—	124"



Heights measured from bottom of auger spout to ground.

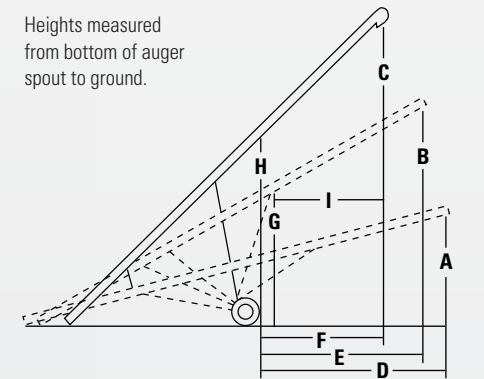

## HORSEPOWER REQUIREMENTS

	6"			8"			10"		13"	
	GAS HP	PTO HP	ELEC. HP	GAS HP	PTO HP	ELEC. HP	PTO HP	ELEC. HP	PTO HP	ELEC. HP
26'	10	—	3	14	—	3 - 5	—	—	—	—
31'	10	—	3	16	—	5	30	7.5 - 10	40	20
36'	12	—	3	16	—	5 - 7.5	—	—	40 - 50	20 - 25
41'	12	—	3	16	—	5 - 7.5	40	10 - 15	50	25
46'	—	—	—	18	—	7.5	—	—	—	—
51'	—	20	5	18	—	7.5	45	15 - 20	70	NA
56'	—	—	—	—	30	10	—	—	—	—
61'	—	25	7.5	—	35	10	55	20	80	NA
71'	—	—	—	—	45	15	60	20 - 25	90	NA

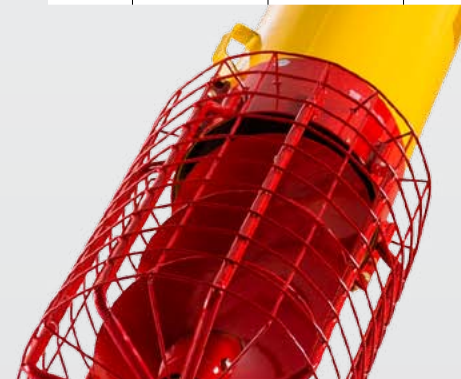

IT'S NOT AN ORDINARY AUGER... **IT'S A WESTFIELD.**



**SAFETY  
FIRST**

Westfield augers are designed with operator safety in mind.  
For more information on how to safely operate your Westfield auger,  
please refer to the product manual or visit [grinaugers.com](http://grinaugers.com).

**WESTFIELD** 

Box 39, 74 Main Street, Rosenort, Manitoba, Canada R0G 1W0  
866.467.7207 | [grinaugers.com](http://grinaugers.com)

0117-2000

**AGI**   
AG GROWTH INTERNATIONAL