



## TRACKED EXCAVATOR | JS131 LC

Engine power: 74 hp (55 kW) Bucket capacity: 12.4 – 31.4 ft<sup>3</sup> Operating weight: 30,845 – 31,499 lb



# STRENGTH INSIDE AND OUT.

DESIGNED TO WITHSTAND THE RIGOURS OF ANY CONSTRUCTION SITE, THE JCB JS131 EXCAVATOR IS BUILT FROM THE HIGHEST QUALITY MATERIALS AND COMPONENTS, USING ADVANCED MANUFACTURING TECHNOLOGIES.



1

## Boom and dipper.

- 1 The JCB JS131 features a reinforced boom and dipper made of high-strength steel, with internal baffle plates for long life durability.
- 2 Advanced JCB manufacturing and assembly processes produce high precision, premium-quality assembled components.



2

## Components.

- 3 JCB engines are proven performers, with more than 450,000 engine units built since 2004. The JCB EcoMAX T4F engine in the JS131 has been tested for more than 110,000 hours in 70 different machines, in the toughest applications and environments in the world.
- 4 The JCB JZ141 features the industry's best components, including Berco running gear, Kawasaki pumps, Kayaba main control valves and a JCB EcoMAX engine.

Finite Element Analysis, with extensive rig and endurance testing, ensures that key components last longer.

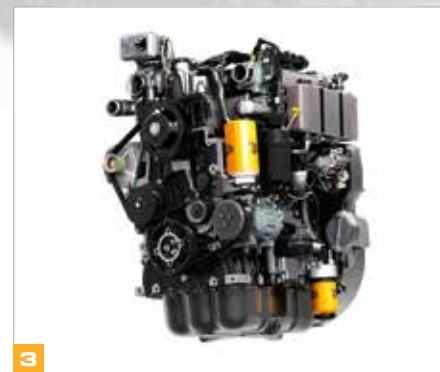

3



4



The JCB JS131 turret is welded to both the upper and lower undercarriage frame.

### Structural strength.

- 5 The high-strength undercarriage of a JCB JS131 uses a fully-welded X-frame construction for long-term durability.
- 6 A closed-box-section revolving frame increases strength, reduces stress and is highly resistant to impact damage.
- 7 The rigid upper frame in the JS131 provides maximum durability and support.
- 8 A rigid, durable door design provides added strength.

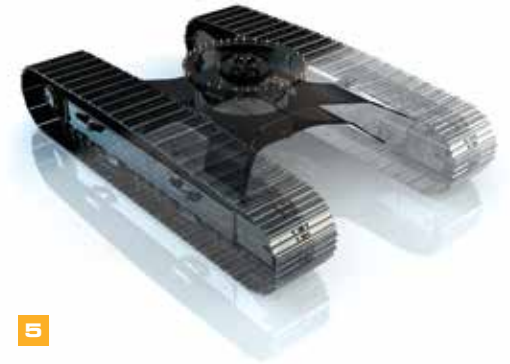

5



6



8



7

# MAXIMUM PRODUCTIVITY, MINIMUM SPEND.

THE JCB JS131 DELIVERS UNPARALLELED PERFORMANCE AND UNBEATABLE PRODUCTIVITY. THE POWERFUL AND EFFICIENT JCB ECOMAX ENGINE REQUIRES NO DPF OR DEF, AND WORKS IN HARMONY WITH OTHER MACHINE COMPONENTS FOR MAXIMUM EFFICIENCY.



## Versed in versatility.

**1** The JCB quick hitch system is purpose-designed for the JS range, and makes changing attachments quicker and easier.

Hammer and auxiliary pipework options are available, to run a variety of attachments.

Optional rubber street pads allow the JS131 to operate on surfaces such as tarmac and sealed roads, without causing damage.

The JS131's relatively low operating weight allows for easy towing\*, making it an excellent solution for rental and urban applications.



The JS131 supports a wide range of attachments for maximum versatility.

\* Subject to local regulations.

## Upping output.

- 5 Simultaneous tracking and excavating is smooth and fast. Proportional controls allow precise command of attachments.
- 6 The JCB JS131 provides a solid, stable work platform for fast cycle times.
- 7 With an impressive 20,660 lbf bucket tearout, the JS131 is extremely productive in all applications.
- 8 JCB's innovative hydraulic regeneration system recycles oil across the cylinders for faster cycle times and reduced fuel consumption.

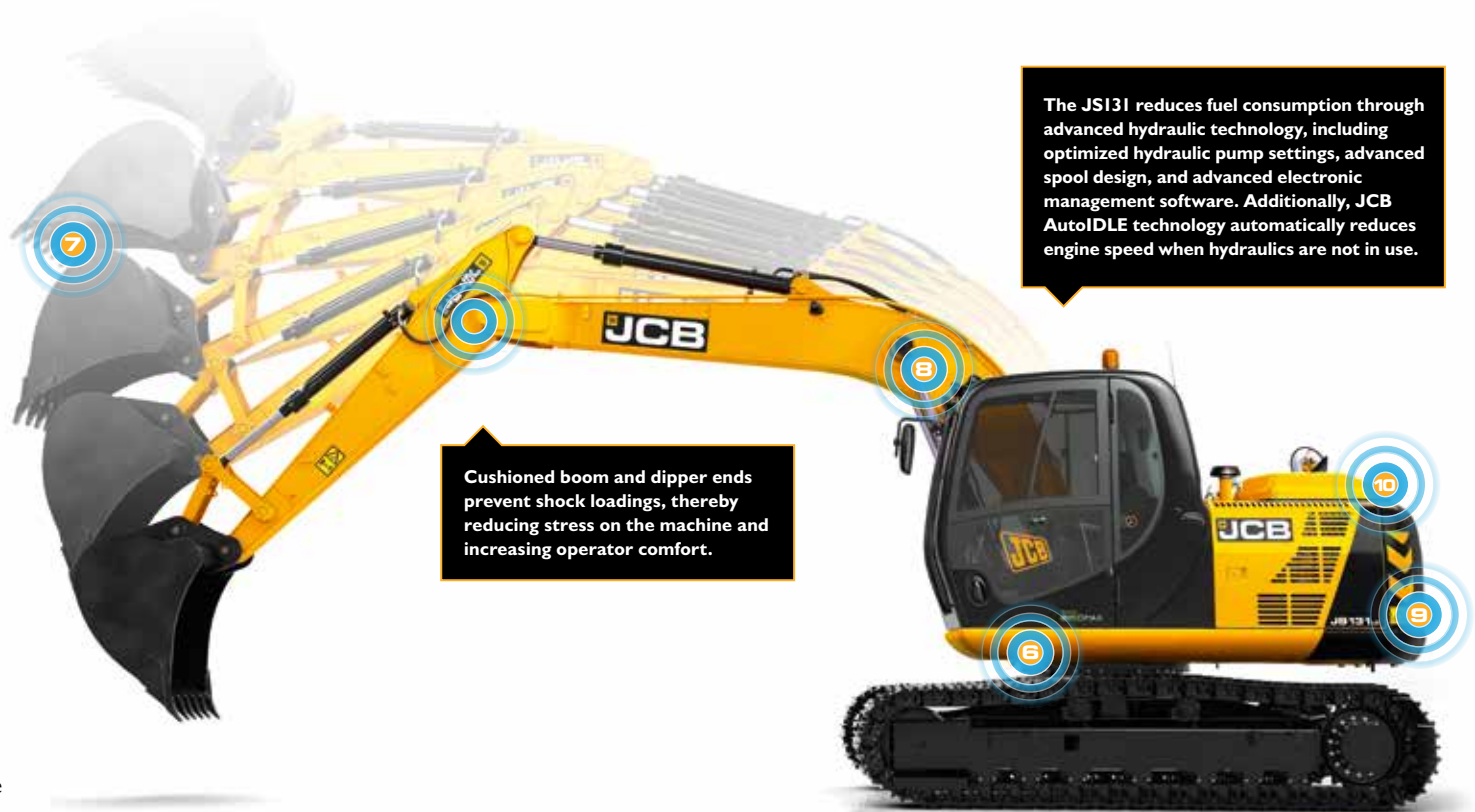

Cushioned boom and dipper ends prevent shock loadings, thereby reducing stress on the machine and increasing operator comfort.

The JS131 reduces fuel consumption through advanced hydraulic technology, including optimized hydraulic pump settings, advanced spool design, and advanced electronic management software. Additionally, JCB AutoIDLE technology automatically reduces engine speed when hydraulics are not in use.

## The efficient excavator.

- 9 The JCB EcoMAX T4F 74 hp (55 kW) engine produces peak torque at just 1,200 RPM, for improved fuel-efficient matching to the hydraulic system, resulting in fuel savings of up to 10 percent.
- 10 The JS131 features an engine-driven cooling fan with a proportional control system, to maintain optimum fan speed.
- 11 Variable power bands allow performance – and fuel efficiency – to be matched to specific tasks.



## A COMFORTABLE FAVORITE.

JCB EXCAVATORS ARE DESIGNED AROUND THE OPERATOR AND FEATURE INTUITIVE CONTROLS AND A COMFORTABLE, DISTRACTION-FREE WORK ENVIRONMENT.

A large, laminated glass window in the roof enables excellent visibility when working at height.

Intuitive controls improve comfort and productivity. The JS131's joystick-mounted power boost button delivers extra hydraulic power when its needed.

A balanced slew and electronic/hydraulic-controlled slew braking are responsive and precise.

### Visibly better.

- 1 A 70/30 front windshield provides excellent front visibility and a clear view of the front right track, for safer digging and maneuvering.
- 2 An innovative, low-level hood provides excellent rearward visibility.

### Comfortably in control.

- 3 The color, 7-inch, multi-function display is easy to read in all light conditions. The home screen can be customized and operational information is provided in real time.



Cab settings and controls are independently adjustable, to create a tailored operating environment.

### The working environment.

**4** The JS131 creates a quieter working environment inside and out. Noise levels are reduced to 70 dB (A) inside and 98dB (A) outside.

JCB cabs use six viscous rubber mounts to minimize noise and vibration.

A positive-pressure environment keeps out dirt and dust.

**5** JCB's climate control option offers a precisely controlled cab temperature with fresh or recirculated air. Demisting/defrosting functions keep the front windshield clear.

**6** The cab features a spacious luggage tray behind the operator's seat.

**7** A large floor area with large, high-grip pedals enables easy and precise tracking.



5



6



7

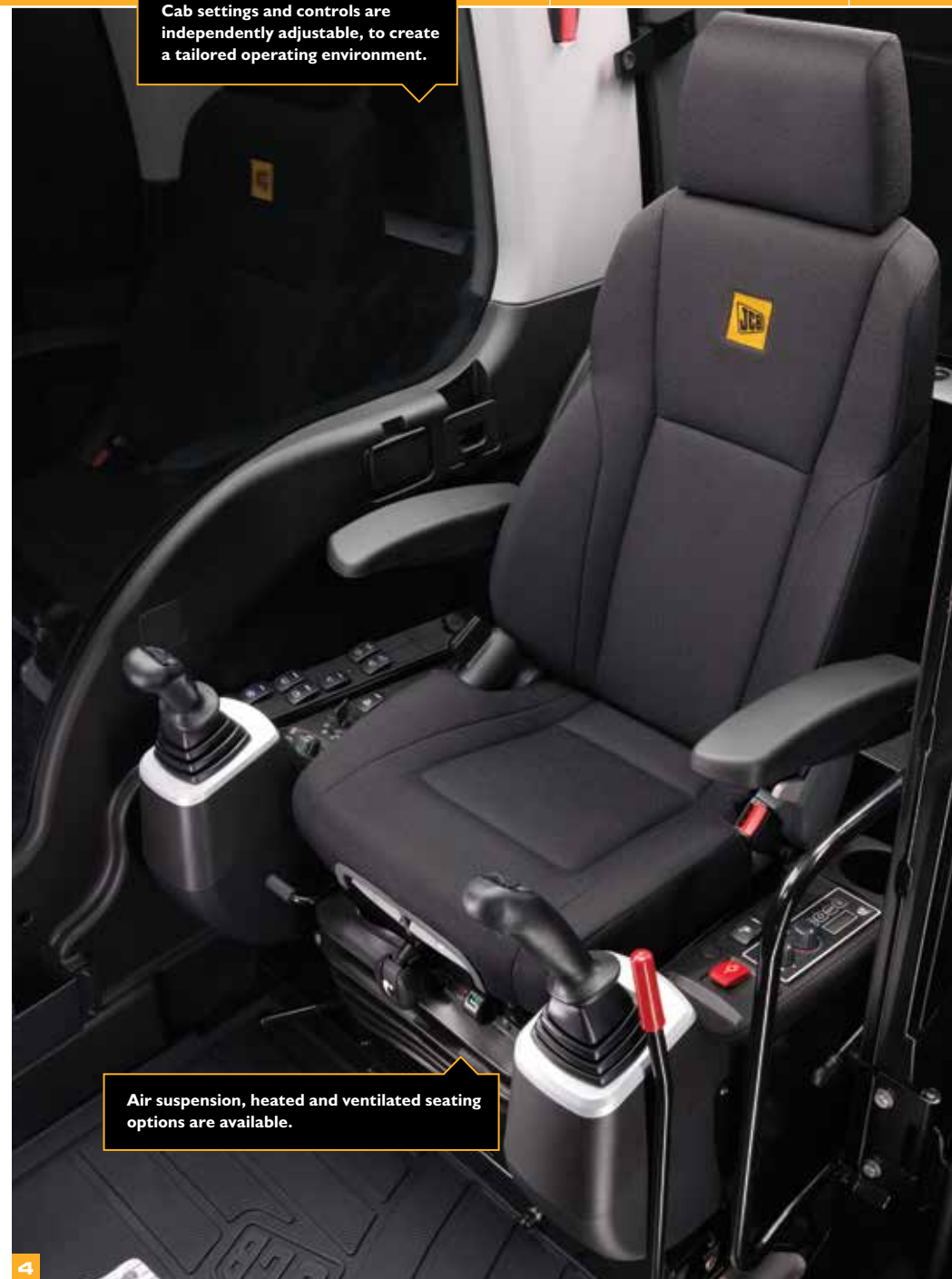

Air suspension, heated and ventilated seating options are available.

4

# LESS SERVICING, MORE SERVICE.

THE JCB JS131 IS DESIGNED FOR REDUCED MAINTENANCE AND EASY SERVICING, ALLOWING MORE UPTIME AND GREATER PRODUCTIVITY.

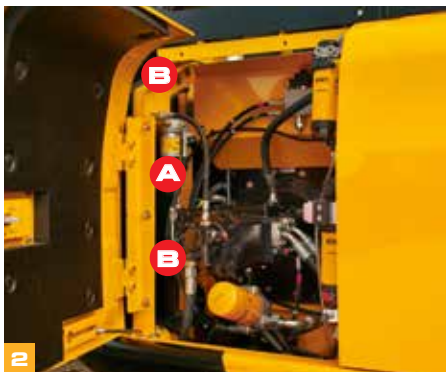

(A) Hydraulics oil filters (B) Fuel filters

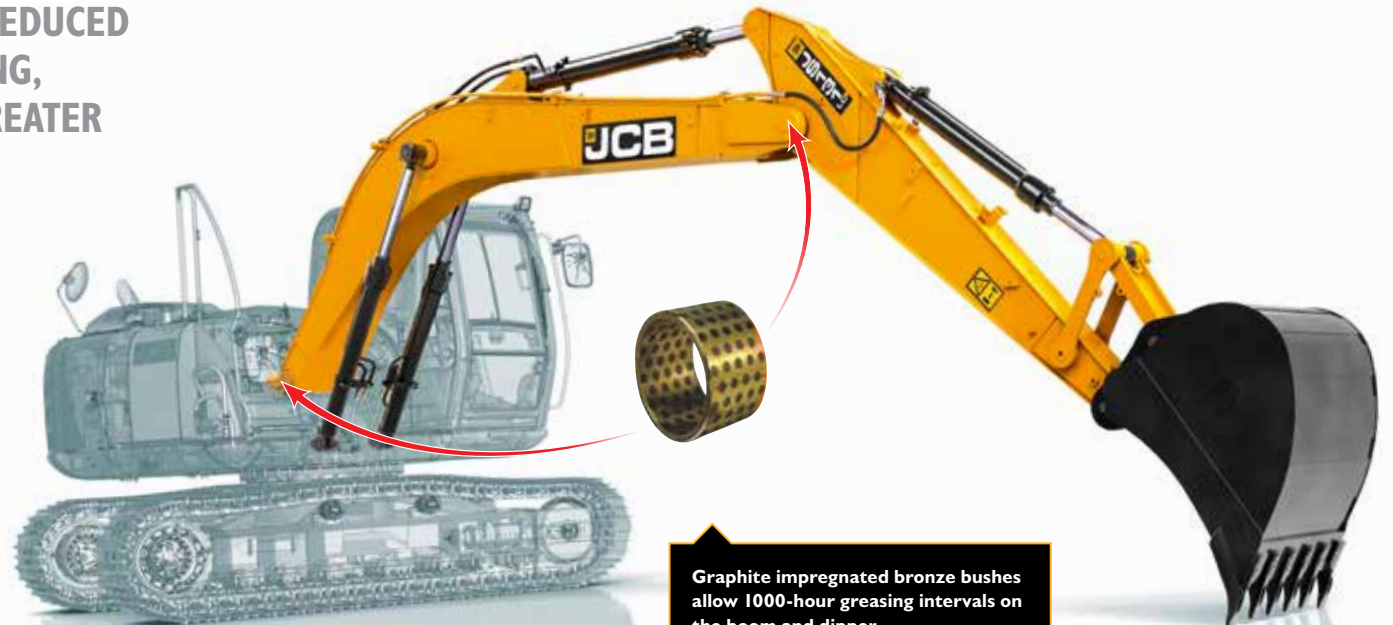

Graphite impregnated bronze bushes allow 1000-hour greasing intervals on the boom and dipper.

## Easy does it.

- 1** The air filter on a JS131 is easily accessible, and a double-element construction simplifies cleaning.
- 2** Filters for engine oil, hydraulic oil and fuel are centrally located for fast servicing.
- 3** The engine radiator, hydraulic cooler and intercooler are mounted side-by-side, so each can be serviced individually and cleaned easily.

	SERVICE INTERVALS
Engine oil and oil filter	Every <b>500</b> hours
Hydraulic oil	Every <b>5000</b> hours
Hydraulic oil filter	Every <b>1000</b> hours







4

**Saving you time and money.**

4 The JCB EcoMAX 74 hp (55 kW) engine in the JS131 requires no diesel particulate filter (DPF) or diesel engine fluid (DEF) and no additional engine aftertreatment.

5 An available scavenger filtration system uses suction from the cooling fan to remove heavier particles from the induction system, eliminating the need for a visibowl-style pre-cleaner.

6 The recalibration option allows the JCB EcoMAX engine to run on lower grade fuels, allowing the JS131 to be resold across territories, for increased residual values.

7 Engine oil levels, coolant, and system errors are automatically checked on start-up, and the results are displayed on the in-cab monitor.



Engine covers open and close easily with gas-assisted cylinders, allowing easy access to the large service areas.



5



6



7

## THE SAFE CHOICE.

THE JCB JS131 IS DESIGNED FOR THE ENHANCED SAFETY OF THE OPERATOR AND OTHERS ON THE JOB SITE.



**1** The JS131 hood opens front-to-rear for easy and safe engine access.



**2** For extra peace of mind, JCB cabs are available with an integral Rollover Protection Structure (ROPS). Additionally, JCB's Falling Object Guard Structure (FOGS) uses standard mounting brackets.

**3** JCB JS131s feature large glass areas and low hood line for superb visibility.

**4** Steps and platforms are constructed from anti-slip punched steel plates for optimum grip in wet or icy conditions. Bolts are recessed bolts to reduce trip hazards.

**5** Optional rear and side view cameras display uninterrupted rear and side views via the smart controller display.



A bulkhead heat shield, between the pumps and the engine, guards against heat and noise.



6 Side and rear view mirrors enhance all-around visibility and safety compliance.

7 JCB's Safety Level Lock fully isolates hydraulic functions to avoid unintended movements. The JCB 2GO system requires two, separate inputs from the operator, preventing the machine from being started when it is not in a safe, locked position.

8 There's no need to climb onto the JS131 to complete your daily checks; all routine checkpoints can be done from ground level.

9 Optional safety rails protect operators from falls from the upper structure.

10 Optional beacons enhance on-site safety.

11 Optional LED work lights improve visibility in low-light conditions.



7



8



9



11

# LIVELINK, WORK SMARTER.

**LiveLink** tracks the efficiency of your machines to maximize ROI.

- Manage your fleet from anywhere
- Reduce operating costs
- Improve productivity
- Monitor fuel and consumption\*
- Receive reports by day / week / month

*\*For machines with electronic engine management system only*

**LiveLink** sends service alerts and diagnostic warnings for effective maintenance planning.

- Machine health alerts
- Machine service alerts
- Accurate hours recorded
- Detailed machine history



**LiveLink** reports the exact location, movement and activity of your machine for improved security.

- Pinpoint machine location
- 24/7 update on your phone/tablet
- Real-time curfew alerts
- Real-time geofence alerts
- Back-up battery
- Tow-away alert



**JCB LiveLink**

**Enhanced Dealer Support**

**Machine Servicing Agreement**

**Superior Build Quality**

Note: Please consult your local dealer for LiveLink availability.

## VALUE ADDED.

WHATEVER YOU NEED AND WHEREVER YOU ARE, THE DEPENDABLE JCB DEALER NETWORK IS HERE TO MAKE SURE YOUR MACHINERY PERFORMS TO ITS FULL POTENTIAL.



**1** JCB Technical Support Service provides instant access to factory expertise, day or night. JCB's Finance and Insurance teams are always on hand to provide fast, flexible, competitive quotes.



**2** The global network of JCB Parts Centers is a model of efficiency. With 16 regional bases, we can deliver around 95 percent of all parts anywhere in the world within 24 hours. Our genuine JCB parts are designed to work in perfect harmony with your machine for optimum performance and productivity.



**3** JCB Yellow Shield offers comprehensive extended warranties and service agreements, as well as service-only or repair and maintenance contracts. JCB maintenance teams offer competitive labor rates and no obligation quotes.

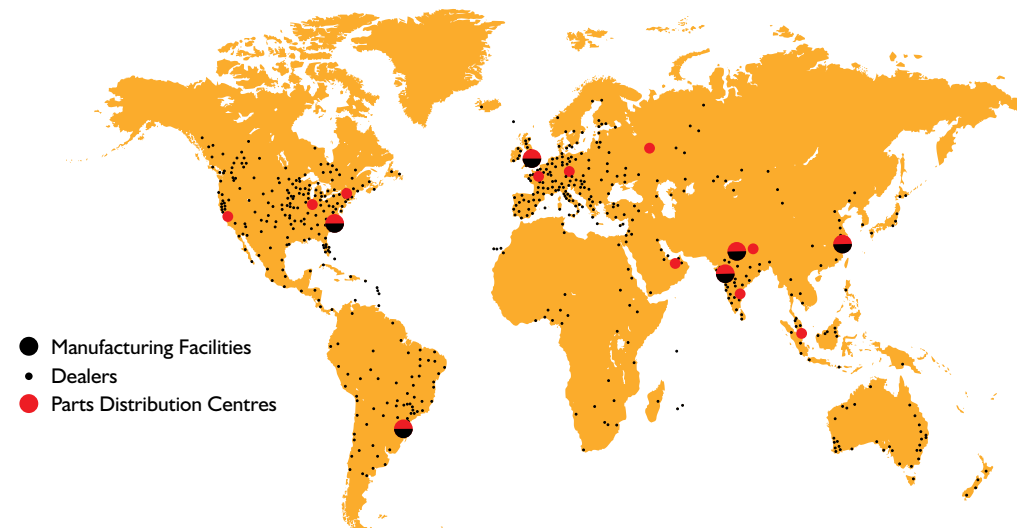

*JCB LiveLink and JCB Yellow Shield may not be available in your region, so please check with your local dealer.*

STATIC DIMENSIONS

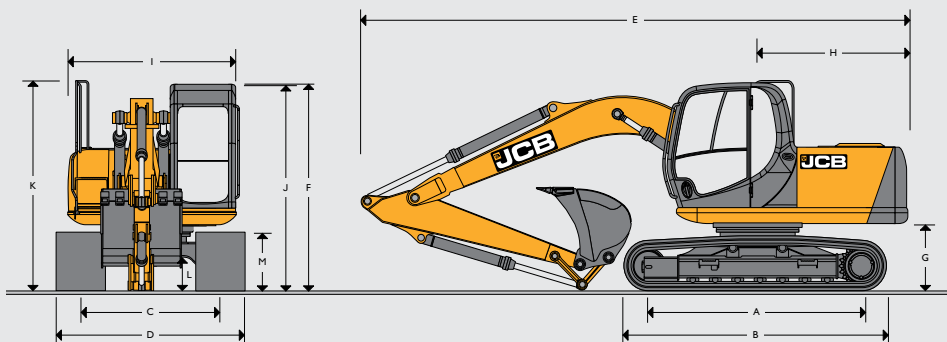

STATIC DIMENSIONS

A	Track length on ground	ft-in (mm)	9-5 (2,865)			
B	Undercarriage overall length	ft-in (mm)	11-10 (3,605)			
C	Track gauge	ft-in (mm)	6-6 (1,990)			
D	Width over tracks (20 inch trackshoes)	ft-in (mm)	8-2 (2,490)			
D	Width over tracks (24 inch trackshoes)	ft-in (mm)	8-6 (2,590)			
D	Width over tracks (28 inch trackshoes)	ft-in (mm)	8-10 (2,690)			
D	Width over tracks (33 inch trackshoes)	ft-in (mm)	9-4 (2,840)			
<b>Arm lengths</b>			<b>6'11" (2.1)</b>	<b>8'2" (2.5)</b>	<b>8'10" (2.7)</b>	<b>9'10" (3.0)</b>
E	Transport length	ft-in (mm)	24-8 (7,515)	24-6 (7,478)	24-4 (7,420)	23-11 (7,300)
F	Transport height	ft-in (mm)	9-5 (2,867)	9-5 (2,867)	10-6 (3,209)	10-9 (3,289)
G	Counterweight clearance	ft-in (mm)	3-0 (905)			
H	Tail swing radius	ft-in (mm)	7-0 (2,135)			
I	Width of superstructure	ft-in (mm)	7-11 (2,410)			
J	Height over cab	ft-in (mm)	9-4 (2,845)			
K	Height over grab rail	ft-in (mm)	9-5 (2,867)			
L	Ground clearance	ft-in (mm)	1-5 (425)			
M	Track height	ft-in (mm)	2-8 (811)			

ENGINE

Model	JCB EcoMAX 444 TCA 55 EU Stage IIIB, EPA Tier 4 Final compliant.
Type	Water cooled, 4-stroke, 4-cylinder in-line, common rail injection, turbocharged fixed geometry intercooled diesel.
Rated power (ISO 14396)	74 hp (55 kW) @ 1800 RPM
Piston displacement	4.4 liters
Air filtration	Dry.
Starting system	24 V
Batteries	2 x 12 V
Alternator	24 V, 55 amp

SLEW SYSTEM

Slew motor	Axial piston type
Slew brake	Hydraulic braking plus automatic spring applied disc type parking brake.
Slew torque	8,138 lbf (36.2 kNm)
Slew speed	13.3 RPM
Slew gear	Large diameter, internally toothed fully sealed grease bath lubricated.

UNDERCARRIAGE

Recovery point	Front and rear.	
Upper & lower rollers	Heat treated, sealed and lubricated.	
Track adjustment	Grease cylinder type.	
Track type	Sealed and lubricated.	
Track idler	Sealed and lubricated, with spring cushioned recoil.	
Track shoes	20-inch (500 mm) triple grouser	20-inch (500 mm) GEOGRIP
	24-inch (600mm) triple grouser	20-inch (500 mm) Rubber shoes
	28-inch (700 mm) triple grouser	24-inch (600 mm) Rubber shoes
	33-inch (850 mm) triple grouser	
Rollers and Shoes (each side)		
Upper rollers	2	
Lower rollers	7	
Track shoes	44	

TRACK DRIVE

Type	Fully hydrostatic, two speed with autoshift between high and low speed.
Travel motors	Variable swash axial piston type, fully guarded within undercarriage frame.
Final drive	Planetary reduction, bolt-on sprockets.
Servcie brake	Hydraulic counter balance valve.
Park brake	Disc type, spring applied, automatic hydraulic release.
Gradeability	70% (35 deg.) continuous.
Travel speed	High – 4.1 mp/h (6.6 km/h) Low – 2.4 mp/h (3.8 km/h)
Tractive effort	22,908 lbf (101.9 kNm)

**HYDRAULIC SYSTEM**

Pumps	
Main pumps	2 variable displacement axial piston type.
Maximum flow	2 x 34.3 gal/min (130 l/min)
Servo pump	Gear type.
Maximum flow	5.3 gal/min (20 L/min)
Control valve	
A combined four and five spool control valve with auxiliary service spool as standard	
Relief valve settings	
Boom/Arm/Bucket	4,554 psi (314 bar)
With power boost	4,975 psi (343 bar)
Swing circuit	4,047 psi (279 bar)
Travel circuit	4,975 psi (343 bar)
Pilot control	580 psi (40 bar)
Filtration	
In tank	150 micron, suction strainer.
Main return line	10 micron, glass fibre element.
Pilot line	10 micron, paper element.
Hydraulic hammer return	10 micron, reinforced microform element.

**SERVICE CAPACITIES**

	Gallons (Litres)
Fuel tank	58 (220)
Engine coolant	5.2 (19.7)
Engine oil	3.7 (14)
Swing reduction gear	0.6 (2.2)
Track reduction gear (each side)	0.9 (3.5)
Hydraulic system	33.3 (126)
Hydraulic tank	19.3 (73)

**WEIGHTS AND GROUND BEARING PRESSURES**

Shoe Width	Operating Weight	Bearing Pressure
Machine equipped with 15'5" (4.7 m) Monoboomb, 8'2" (2.5 m) Dipper, 944 lb (417 kg) Excavating Bucket, operator and full fuel tank.		
20 inch	30,117 lb (13,661 kg)	6.26 lb/in <sup>2</sup> (0.44 kg/sq.com)
24 inch	30,353 lb (13,768 kg)	5.26 lb/in <sup>2</sup> (0.37 kg/sq.com)
28 inch	30,591 lb (13,876 kg)	4.55 lb/in <sup>2</sup> (0.32 kg/sq.com)
33 inch	30,948 lb (14,038 kg)	3.84 lb/in <sup>2</sup> (0.27 kg/sq.com)

**BUCKET AND ARM COMBINATION**

Bucket options	GP Bucket								Grade Bucket		
	24 (600)	28 (700)	31 (800)	39 (1,000)	47 (1,200)	51 (1,300)	60 (1,524)	72 (1,836)	72 (1,836)	72 (1,836)	72 (1,836)
Bucket width in (mm)	24 (600)	28 (700)	31 (800)	39 (1,000)	47 (1,200)	51 (1,300)	60 (1,524)	72 (1,836)	72 (1,836)	72 (1,836)	72 (1,836)
Bucket capacity ft <sup>3</sup> (m <sup>3</sup> )	12.4 (.35)	14.8 (.42)	17.7 (.50)	23.3 (.66)	28.6 (.81)	31.4 (.89)	23.0 (.65)	27.9 (.79)	27.9 (.79)	27.9 (.79)	27.9 (.79)
Bucket weight lb (kg)	631 (286)	688 (312)	739 (335)	844 (383)	944 (428)	1,001 (454)	996 (452)	1,129 (512)	1,281 (581)	1,281 (581)	1,281 (581)
6'1 1" quick hitch (No quick hitch)	☐ (☐)	☐ (☐)	☐ (☐)	■ (☐)	● (■)	● (■)	■ (☐)	● (■)	● (■)	● (■)	● (■)
8'2" quick hitch (No quick hitch)	☐ (☐)	☐ (☐)	☐ (☐)	■ (☐)	● (■)	● (●)	■ (■)	● (●)	● (●)	● (●)	● (●)
8'10" quick hitch (No quick hitch)	☐ (☐)	☐ (☐)	☐ (☐)	■ (■)	● (●)	✕ (●)	● (■)	● (●)	● (●)	✕ (●)	✕ (●)
9'10" quick hitch (No quick hitch)	☐ (☐)	☐ (☐)	☐ (☐)	● (■)	✕ (●)	✕ (●)	● (■)	✕ (●)	✕ (●)	✕ (●)	✕ (●)

☐ = Material weight up to 112.4 lb/ft<sup>3</sup> (1,800 kg/m<sup>3</sup>).

● = Material weight up to 93.6 lb/ft<sup>3</sup> (1,500 kg/m<sup>3</sup>).

■ = Material weight up to 74.9 lb/ft<sup>3</sup> (1,200 kg/m<sup>3</sup>).

These recommendations are given as a guide based on typical operating conditions.

Please contact your distributor for the correct selection of buckets and attachments to suit the application.

**WORKING RANGE**





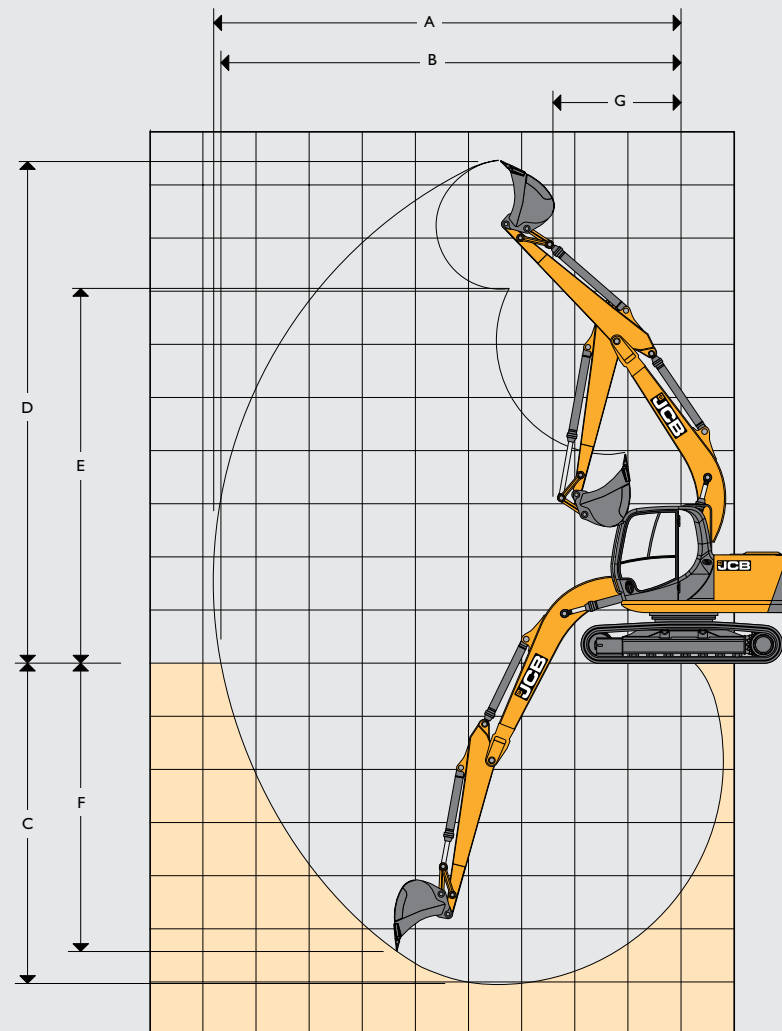





Dipper length:		6'11" (2.1 m)	8'2" (2.5 m)	8'10" (2.7 m)	9'10" (3.0 m)	
A	Maximum digging reach	ft-in (mm)	24-8 (7,517)	27-4 (8,340)	28-0 (8,522)	28-10 (8,796)
B	Maximum digging reach (on ground)	ft-in (mm)	24-2 (7,356)	26-11 (8,197)	27-6 (8,380)	28-5 (8,660)
C	Maximum digging depth	ft-in (mm)	15-9 (4,809)	18-2 (5,530)	17-10 (5,425)	19-9 (6,028)
D	Maximum digging height	ft-in (mm)	27-6 (8,375)	29-11 (9,118)	30-4 (9,242)	31-0 (9,440)
E	Maximum dumping height	ft-in (mm)	20-1 (6,115)	22-1 (6,729)	22-6 (6,855)	23-1 (7,041)
F	Maximum vertical wall cut depth	ft-in (mm)	10-7 (3,219)	11-11 (3,625)	12-2 (3,712)	13-3 (4,050)
G	Minimum swing radius	ft-in (mm)	7-8 (2,337)	7-4 (2,231)	8-3 (2,505)	8-6 (2,591)
	Bucket rotation	deg	182°	182°	182°	182°
	Maximum dipper tearout	lbf (kNm)	16,299 (72.5)	14,523 (64.6)	14,208 (63.2)	13,196 (58.7)
	Maximum bucket tearout	lbf (kNm)	20,660 (91.9)	20,660 (91.9)	20,660 (91.9)	20,660 (91.9)

**WORKING RANGE**















**LIFT CAPACITIES – DIPPER LENGTH: 6'11" (2.1 M), 15'5" (4.70 M) MONOBOOM, TRACKSHOES: 20-INCH (500 MM), NO BUCKET** **JS131 LC**

Reach	9'10" (3 m)		13'1" (4 m)		16'5" (5 m)		19'8" (6 m)		Capacity at Max Reach		ft-in (mm)
	 lb (kg)	 lb (kg)	 lb (kg)	 lb (kg)	 lb (kg)	 lb (kg)	 lb (kg)	 lb (kg)	 lb (kg)	 lb (kg)	
Load Point Ht.											
19'8" (6 m)			7,121 (3,230)	7,121 (3,230)	7,099 (3,230)	7,099 (3,220)			6,526 (2,960)	6,526 (2,960)	16-5 (5,044)
16'5" (5 m)			7,452 (3,380)	7,452 (3,380)	7,363 (3,340)	7,143 (3,340)			6,085 (2,760)	5,600 (2,540)	19-0 (5,792)
13'1" (4 m)	9,965 (4,520)	9,965 (4,520)	8,576 (3,890)	8,576 (3,890)	7,848 (3,560)	6,989 (3,170)	7,430 (3,370)	5,269 (2,390)	5,908 (2,680)	4,850 (2,200)	20-6 (6,293)
9'10" (3 m)	13,580 (6,160)	13,580 (6,160)	10,229 (4,640)	9,436 (4,280)	8,708 (3,950)	6,790 (3,080)	7,341 (3,330)	5,159 (2,340)	5,908 (2,680)	4,431 (2,010)	21-7 (6,603)
6'7" (2 m)			12,015 (5,450)	8,973 (4,070)	9,458 (4,290)	6,548 (2,970)	7,209 (3,270)	5,049 (2,290)	6,041 (2,740)	4,233 (1,920)	22-1 (6,750)
3'3" (1 m)			12,985 (5,890)	8,642 (3,920)	9,237 (4,190)	6,349 (2,880)	7,077 (3,210)	4,938 (2,240)	5,974 (2,710)	4,167 (1,890)	22-1 (6,745)
0'0" (0 m)	13,492 (6,120)	12,963 (5,880)	12,743 (5,780)	8,444 (3,830)	9,083 (4,120)	6,195 (2,810)	6,989 (3,170)	4,850 (2,200)	6,129 (2,780)	4,277 (1,940)	21-6 (6,587)
(-) 3'3" (1 m)	18,717 (8,490)	12,963 (5,880)	12,676 (5,750)	8,377 (3,800)	9,017 (4,090)	6,151 (2,790)	6,967 (3,160)	4,828 (2,190)	6,570 (2,980)	4,564 (2,070)	20-6 (6,264)
(-) 6'7" (2 m)	17,527 (7,950)	13,051 (5,920)	12,698 (5,760)	8,400 (3,810)	9,039 (4,100)	6,151 (2,790)			7,452 (3,380)	5,159 (2,340)	18-9 (5,749)
(-) 9'10" (3 m)	15,410 (6,990)	13,272 (6,020)	11,927 (5,410)	8,532 (3,870)					8,907 (4,040)	6,349 (2,880)	16-3 (4,979)

**LIFT CAPACITIES – DIPPER LENGTH: 8'2" (2.50 M), 15'5" (4.70 M) MONOBOOM, TRACKSHOES: 20-INCH (500 MM), NO BUCKET.** **JS131 LC**

Reach	9'10" (3 m)		13'1" (4 m)		16'5" (5 m)		19'8" (6 m)		Capacity at Max Reach		ft-in (mm)
	 lb (kg)	 lb (kg)	 lb (kg)	 lb (kg)	 lb (kg)	 lb (kg)	 lb (kg)	 lb (kg)	 lb (kg)	 lb (kg)	
Load Point Ht.											
19'8" (6 m)			6,173 (2,800)	6,173 (2,800)	6,636 (3,010)	6,636 (3,010)			5,225 (2,370)	5,225 (2,370)	18-2 (5,533)
16'5" (5 m)			6,570 (2,980)	6,570 (2,980)	6,658 (3,020)	6,658 (3,020)	6,856 (3,110)	5,357 (2,430)	4,938 (2,240)	4,938 (2,240)	20-4 (6,221)
13'1" (4 m)	8,510 (3,860)	8,510 (3,860)	7,694 (3,490)	7,694 (3,490)	7,209 (3,270)	7,077 (3,210)	6,989 (3,170)	5,313 (2,410)	4,828 (2,190)	4,431 (2,010)	21-9 (6,689)
9'10" (3 m)	11,905 (5,400)	11,905 (5,400)	9,370 (4,250)	9,370 (4,250)	8,113 (3,680)	6,856 (3,110)	7,385 (3,350)	5,203 (2,360)	4,828 (2,190)	4,079 (1,850)	22-9 (6,982)
6'7" (2 m)	15,719 (7,130)	13,911 (6,310)	11,243 (5,100)	9,083 (4,120)	9,149 (4,150)	6,592 (2,990)	5,247 (2,380)	5,049 (2,290)	4,960 (2,250)	3,902 (1,770)	23-4 (7,121)
3'3" (1 m)	14,043 (6,370)	13,206 (5,990)	12,809 (5,810)	8,686 (3,940)	9,259 (4,200)	6,349 (2,880)	7,077 (3,210)	5,688 (2,580)	5,203 (2,360)	3,836 (1,740)	23-3 (7,116)
0'0" (0 m)	15,057 (6,830)	12,919 (5,860)	12,743 (5,780)	8,422 (3,820)	9,083 (4,120)	6,195 (2,810)	6,967 (3,160)	4,806 (2,180)	5,600 (2,540)	3,924 (1,780)	22-9 (6,967)
(-) 3'3" (1 m)	19,026 (8,630)	12,831 (5,820)	12,610 (5,720)	8,311 (3,770)	8,973 (4,070)	6,085 (2,760)	6,900 (3,130)	4,762 (2,160)	5,974 (2,710)	4,145 (1,880)	21-9 (6,663)
(-) 6'7" (2 m)	18,166 (8,240)	12,897 (5,850)	12,610 (5,720)	8,311 (3,770)	8,951 (4,060)	6,085 (2,760)	9,127 (4,140)	4,784 (2,170)	6,658 (3,020)	4,608 (2,090)	20-3 (6,181)
(-) 9'10" (3 m)	16,446 (7,460)	13,073 (5,930)	11,839 (5,370)	8,400 (3,810)	9,039 (4,100)	6,151 (2,790)			7,981 (3,620)	5,489 (2,490)	18-0 (5,474)

 Lift capacity front and rear.











 Lift capacity full circle.

**Notes:**

1. For lifting capacity including bucket, subtract total weight of bucket or bucket and quick hitch from above values.
2. Lifting capacities are based on ISO 10567, that is: 75% of minimum tipping load or 87% of hydraulic lift capacity, whichever is the less. Lifting capacities marked\* are based on hydraulic capacity.
3. Lift capacities assume that the machine is on firm, level ground.
4. Lift capacities may be limited by local regulations. Please refer to your dealer.











**LIFT CAPACITIES – DIPPER LENGTH: 8'10" (2.70 M), 15'5" (4.70 M) MONOBOOM, TRACKSHOES: 20-INCH (500 MM), NO BUCKET.**

JS131 LC

Reach	9'10" (3 m)		13'1" (4 m)		16'5" (5 m)		19'8" (6 m)		Capacity at Max Reach		ft-in (mm)
											
Load Point Ht.	lb (kg)	lb (kg)	lb (kg)	lb (kg)	lb (kg)	lb (kg)	lb (kg)	lb (kg)	lb (kg)	lb (kg)	
19'8" (6 m)					6,261 (2,840)	6,261 (2,840)	0	0	5,578 (2,530)	5,578 (2,530)	18-5 (5,653)
16'5" (5 m)			5,997 (2,720)	5,997 (2,720)	5,997 (2,720)	6,217 (2,820)	6,504 (2,950)	5,379 (2,440)	5,269 (2,390)	4,938 (2,240)	20-8 (6,326)
13'1" (4 m)			6,944 (3,150)	6,944 (3,150)	6,702 (3,040)	6,702 (3,040)	6,614 (3,000)	5,247 (2,380)	5,137 (2,330)	4,321 (1,960)	22-3 (6,785)
9'10" (3 m)	10,273 (4,660)	10,273 (4,660)	8,444 (3,830)	8,444 (3,830)	7,518 (3,410)	6,548 (2,970)	7,033 (3,190)	5,049 (2,290)	5,115 (2,320)	3,968 (1,800)	23-2 (7,075)
6'7" (2 m)	13,823 (6,270)	12,522 (5,680)	10,185 (4,620)	8,422 (3,820)	8,488 (3,850)	6,239 (2,830)	6,944 (3,150)	4,872 (2,210)	5,247 (2,380)	3,770 (1,710)	23-7 (7,210)
3'3" (1 m)	16,579 (7,520)	11,993 (5,440)	11,751 (5,330)	8,025 (3,640)	8,686 (3,940)	5,974 (2,710)	6,768 (3,070)	4,696 (2,130)	5,291 (2,400)	3,682 (1,670)	23-6 (7,205)
0'0" (0 m)	17,835 (8,090)	11,773 (5,340)	11,662 (5,290)	7,760 (3,520)	8,466 (3,840)	5,798 (2,630)	6,614 (3,000)	4,564 (2,070)	5,357 (2,430)	3,726 (1,690)	23-2 (7,060)
(-) 3'3" (1 m)	17,923 (8,130)	11,662 (5,290)	11,530 (5,230)	7,650 (3,470)	8,355 (3,790)	5,688 (2,580)	6,548 (2,970)	4,497 (2,040)	5,644 (2,560)	3,902 (1,770)	22-2 (6,759)
(-) 6'7" (2 m)	17,196 (7,800)	11,618 (5,270)	11,486 (5,210)	7,606 (3,450)	8,311 (3,770)	5,644 (2,560)	6,548 (2,970)	4,497 (2,040)	6,195 (2,810)	4,277 (1,940)	20-6 (6,287)
(-) 9'10" (3 m)	15,675 (7,110)	11,640 (5,280)	11,552 (5,240)	7,672 (3,480)	8,400 (3,810)	5,710 (2,590)			7,275 (3,300)	5,004 (2,270)	18-3 (5,592)

**LIFT CAPACITIES – DIPPER LENGTH: 9'10" (3.00 M), 15'5" (4.7 M) MONOBOOM, TRACKSHOES: 20-INCH (500 MM), NO BUCKET.**

JS131 LC

Reach	9'10" (3 m)		13'1" (4 m)		16'5" (5 m)		19'8" (6 m)		Capacity at Max Reach		ft-in (mm)
											
Load Point Ht.	lb (kg)	lb (kg)	lb (kg)	lb (kg)	lb (kg)	lb (kg)	lb (kg)	lb (kg)	lb (kg)	lb (kg)	
19'8" (6 m)					5,600 (2,540)	5,600 (2,540)	5,556 (2,520)	5,556 (2,460)	4,806 (2,180)	4,806 (2,180)	20-1 (6,113)
16'5" (5 m)					5,754 (2,610)	5,754 (2,610)	5,997 (2,720)	5,997 (2,470)	4,564 (2,070)	4,431 (2,010)	22-1 (6,741)
13'1" (4 m)			6,526 (2,960)	6,526 (2,960)	6,371 (2,890)	6,371 (2,890)	6,261 (2,840)	6,261 (2,430)	4,475 (2,030)	3,946 (1,790)	23-5 (7,175)
9'10" (3 m)	9,833 (4,460)	9,833 (4,460)	8,179 (3,710)	8,179 (3,710)	7,297 (3,310)	6,922 (3,140)	6,790 (3,080)	6,790 (2,370)	4,497 (2,040)	3,660 (1,660)	24-4 (7,448)
6'7" (2 m)	13,691 (6,210)	13,691 (6,210)	10,141 (4,600)	9,215 (4,180)	8,422 (3,820)	6,636 (3,010)	7,231 (3,280)	7,231 (2,290)	4,608 (2,090)	3,505 (1,590)	24-9 (7,578)
3'3" (1 m)	16,843 (7,640)	13,360 (6,060)	11,927 (5,410)	8,730 (3,960)	9,281 (4,210)	6,349 (2,880)	7,055 (3,200)	7,055 (2,220)	4,828 (2,190)	3,461 (1,570)	24-8 (7,574)
0'0" (0 m)	16,557 (7,510)	12,853 (5,830)	12,721 (5,770)	8,400 (3,810)	9,039 (4,100)	6,129 (2,780)	6,922 (3,140)	6,922 (2,160)	5,071 (2,300)	3,505 (1,590)	24-4 (7,434)
(-) 3'3" (1 m)	18,982 (8,610)	12,654 (5,740)	12,500 (5,670)	8,201 (3,720)	8,885 (4,030)	5,997 (2,720)	6,812 (3,090)	6,812 (2,120)	5,335 (2,420)	3,682 (1,670)	23-5 (7,150)
(-) 6'7" (2 m)	18,585 (8,430)	12,632 (5,730)	12,434 (5,640)	8,135 (3,690)	8,818 (4,000)	5,952 (2,700)	6,790 (3,080)	6,790 (2,100)	5,842 (2,650)	4,012 (1,820)	22-0 (6,704)
(-) 9'10" (3 m)	17,372 (7,880)	12,743 (5,780)	12,478 (5,660)	8,179 (3,710)	8,862 (4,020)	5,974 (2,710)	6,856 (3,110)	6,856 (2,130)	6,768 (3,070)	4,652 (2,110)	19-9 (6,060)

 Lift capacity front and rear.

 Lift capacity full circle.

Notes:

1. For lifting capacity including bucket, subtract total weight of bucket or bucket and quick hitch from above values.
2. Lifting capacities are based on ISO 10567, that is: 75% of minimum tipping load or 87% of hydraulic lift capacity, whichever is the less. Lifting capacities marked\* are based on hydraulic capacity.
3. Lift capacities assume that the machine is on firm, level ground.
4. Lift capacities may be limited by local regulations. Please refer to your dealer.





**ONE COMPANY, MORE THAN 300 MACHINES.**

**Tracked Excavator JS131 LC**

Engine power: 74 hp (55 kW) Bucket capacity: 12.4 – 31.4 ft<sup>3</sup> Operating weight: 30,845 – 31,499 lb

**JCB North American**

2000 Bamford Blvd., Pooler, Georgia, 31322 Tel: (912) 447-2000

Download the very latest information on this product range at [www.jcb.com](http://www.jcb.com)

JCB inc. All rights reserved. No part of this publication may be reproduced, stored in a retrieval system, or transmitted in any form or by any other means, electronic, mechanical, photocopying or otherwise, without prior permission from JCB inc. All references in this publication to operating weights, sizes, capacities and other performance measurements are provided for guidance only and may vary dependant upon the exact specification of machine. They should not therefore be relied upon in relation to suitability for a particular application. Guidance and advice should always be sought from your JCB Dealer. JCB reserves the right to change specifications without notice. Illustrations and specifications shown may include optional equipment and accessories. The JCB logo is a registered trademark of J.C. Bamford Excavators Ltd.

Your nearest JCB Dealer

