



TRACKED EXCAVATOR | JS160/190 NLC/LC

Engine power: 125 hp (93 kW) Bucket capacity: 16.2 - 30.0 ft³ Operating weight: 37997 - 46793 lb



STRENGTH INSIDE AND OUT.

BEFORE YOU BUY AN EXCAVATOR, YOU NEED TO KNOW IT'S GOING TO BE TOUGH ENOUGH TO PERFORM ANY JOB YOU ASK OF IT. FORTUNATELY, WITH A JCB JS160/190, STRENGTH AND DURABILITY COME STANDARD.

We use Finite Element Analysis with extensive rig and endurance testing to make key components last longer.



Boom and dipper.

- 1 A JCB JS160/190's reinforced boom and dipper is made of high tensile strength steel, with single piece wrapper plates and internal baffle plates for long life durability.
- 2 Our advanced manufacturing and assembly processes produce high precision and quality assembled components.

1

Componentry.

- 3 Our engine technology is tried and proven; we've built 200,000 DIESELMAX units since 2004. To ensure similar longevity, the JS160/190's EcoMAX T4 Final engine has been tested for 110,000 hours in 70 different machines across the toughest applications and environments.
- 4 JCB JS160/190's boast the best components in the industry, including Berco running gear, Kawasaki pumps, Kayaba valve blocks and JCB EcoMAX engines.



2



3



4



The JCB JS160/190 turret is welded to both the upper and lower undercarriage frame.

Structural strength.

- 5 The high-strength undercarriage of a JCB JS160/190 uses a fully-welded X frame construction for long-term durability even in the most demanding applications.
- 6 A closed box section revolving frame increases strength and reduces stress. It's also highly resistant to impact damage.
- 7 The 160/190's high-strength rigid upper frame provides maximum durability and support.
- 8 Our stiff, durable door design gives great strength and rigidity.

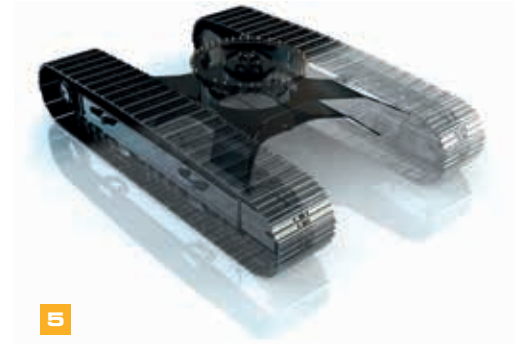

5

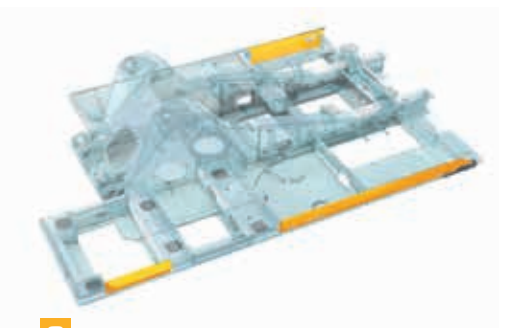

6



8



7

MAXIMUM PRODUCTIVITY, MINIMUM SPEND.

SAVING MONEY AND TIME IS MORE IMPORTANT THAN EVER, SO WE'VE MADE SURE THE NEW JCB JSI60/I90'S COMPONENTRY – INCLUDING THE ECOMAX T4F ENGINE – WORKS IN PERFECT HARMONY. IN TURN, YOU GET A MACHINE THAT'S AS EFFICIENT AND PRODUCTIVE AS POSSIBLE.

Versed in versatility.

1 JCB's quickhitch system makes attachment changing fast and easy, and is purpose-designed for the JS range.

For ultra versatility, JCB offers a full list of auxiliary pipework options including hammer, auxiliary, and low flow.

2 The JSI 60/190 can also be fitted with a range of track shoe options. These span from 20 inches to 35 inches, and ensure your excavator is perfectly tailored to its application and the demands placed on it.

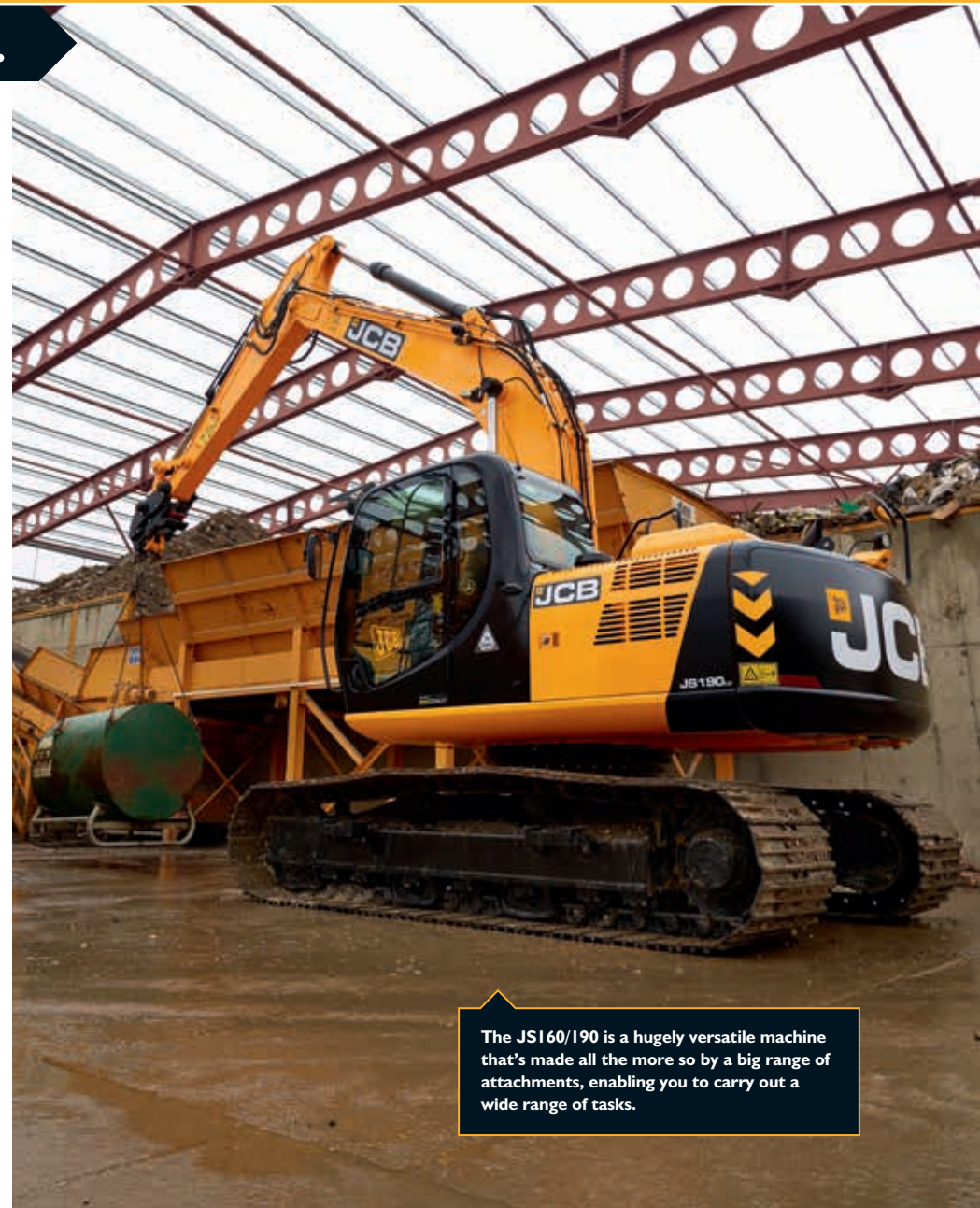

The JSI 60/190 is a hugely versatile machine that's made all the more so by a big range of attachments, enabling you to carry out a wide range of tasks.

Upping output.

- 4 Simultaneous tracking and excavating is smooth and fast with an intuitive multifunction operation.
- 5 A JCB JS160/190 has a solid, stable work platform for fast cycle times.
- 6 With a massive 26438 lbf bucket tearout and fast cycle times, the JS160/190 is extremely productive in all applications.
- 7 JCB's innovative hydraulic regeneration system means oil is recycled across the cylinders for faster cycle times and reduced fuel consumption.

The efficient excavator.

- 8 JCB's new EcoMAX T4 Final engine uses less fuel than our Tier 4i units, saving you money. This is partly due to the fact that EcoMAX produces high torque at just 1500 – 1600 rpm, making for improved fuel-efficient matching of the hydraulics.
- 9 To reduce noise pollution from unnecessary air flow, the JS160/190's engine-driven cooling fan has a proportional control system, maintaining optimum fan speed.
- 10 The JS160/190's variable power bands allow you to tailor performance – and therefore economy – to specific tasks.



To save fuel, JCB Auto-Idle technology automatically reduces engine speed when hydraulics aren't in use. To optimize fuel efficiency still further, the JS160/190 benefits from advanced hydraulic technology, including optimized hydraulic pump settings, advanced spool design, and cutting edge electronic management software.

A JCB JS160/190 has cushioned boom and dipper ends to prevent shock loadings, protect your machine and increase operator comfort.



A COMFORTABLE FAVORITE.

JCB EXCAVATORS ARE DESIGNED AROUND THE OPERATOR. THAT'S GOOD FOR THEM BUT EVEN BETTER FOR YOU; AFTER ALL, GREAT COMFORT AND EASE OF USE EQUALS GREAT PRODUCTIVITY.

Visibly better.

1 A 70/30 front screen split gives JCB JS160/190's excellent front visibility. A clear view of the front right track provides easy, safe trench digging and maneuvering.

2 An innovative low-level hood provides excellent rearward visibility.

Comfortably in control.

3 The 7" color multi-function display is easy to read in all light conditions, provides instant operational information, and has a customizable home screen.

The JS160/190's Tool Select feature can set up auxiliary hydraulic circuits quickly and accurately to match the flow and pressure requirements of any attachment.



A large laminated glass roof window gives the JS160/190 optimum visibility for working at height.

Light, intuitive and smooth controls improve comfort and productivity. The JS160/190's joystick-mounted power boost button gives extra hydraulic power fast.

A balanced slew and electronic/hydraulic controlled slew braking give speed and precision.





5

The working environment.

4 The JS160/190 creates a quieter working environment inside and out. Because we've reduced noise levels to 72dB(A) inside and 99dB(A) outside, you can use the machine at any location, any time.

JCB JS160/190 cabs use 6 viscous rubber mounts to minimize noise and vibration.

The positive pressure cab keeps out dirt and dust.

5 JCB's climate control option offers a precisely controlled cab temperature with fresh or recirculated air. Demisting/defrosting functions keep a JS160/190's front window clear.

6 There's a spacious luggage tray behind the operator's seat.

7 A large floor area with large high grip pedals gives easy and precise tracking.



6



7



The JS160/190's cab and controls are independently adjustable so that it's easy to find the perfect operating position.

We offer tailored seating options to suit many different applications.

4

LESS SERVICING, MORE SERVICE.

WE'VE DESIGNED THE JCB JS160/190 TO BE LOW MAINTENANCE AND EASILY SERVICEABLE. THIS MAKES IT AFFORDABLE, EFFICIENT AND HIGHLY PRODUCTIVE, HELPING YOU GET THE BEST SERVICE FROM YOUR MACHINE.

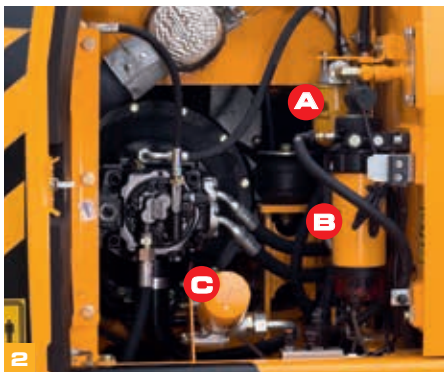

(A) Hydraulics oil filter (B) Fuel filter (C) Engine oil filter



By using graphite impregnated bronze bushes, we've reduced the JS160/190's boom and dipper greasing intervals to 1000 hours for normal applications.

Easy does it.

- 1** The air filter on a JS160/190 is easily accessible, and a double-element construction simplifies cleaning.
- 2** The filters on a JS160/190 (engine oil, hydraulic oil and fuel) are centrally located for fast, easy servicing.
- 3** Because they're mounted side by side on a JCB JS160/190, the engine radiator, hydraulic cooler and intercooler can be serviced individually and cleaned easily.

	SERVICE INTERVALS
Engine oil and oil filter	Every 500 hours
Hydraulic oil	Every 5000 hours
Hydraulic oil filter	Every 1000 hours



Here to help.

4 Because the EcoMAX engine doesn't need exhaust after treatment, it doesn't require costly heat-resistant lube oils. Unlike most Tier 4 engines, JCB EcoMAX doesn't use SCR, saving you additional running costs.

5 We've eliminated the need for a visibowl style pre-cleaner on the JSI 60/190 with our optional new scavenger filtration system. This uses suction from the cooling fan to remove heavier particles from the induction system.

6 Our innovative recalibration option allows EcoMAX to run on lower grade fuels. This means the JSI 60/190 can be resold across different territories, which improves residuals.

7 JCB's In-Cab Monitor checks engine oil levels, coolant, and system errors on start-up.

8 JCB meets the latest EPA Tier 4 Final/Stage IV emissions legislation without the use of a DPF (Diesel Particulate Filter). The Diesel Exhaust Fluid (DEF) tank can be easily accessed via the new revised step layout on the upper structure.



JCB JSI 60/190 grease points are centralized for safe and easy access to high level pivots.

JCB JSI 60/190 hoods open and close easily with gas-assisted cylinders, and the service bays are large and wide for good access.

THE SAFE CHOICE.

ON-SITE SAFETY IS CRUCIAL, SO WE'VE DESIGNED THE JCB JSI60/I90 TO INCORPORATE AS MANY CUTTING EDGE SAFEGUARDS AS POSSIBLE. IN SHORT, YOUR OPERATORS ARE IN SAFE HANDS.

We've fitted as standard a bulk head heat shield between the pumps and the engine to guard against heat and noise.



1 The JSI 60/I90 hood opens front-to-rear for easy and safe engine service access.

2 For extra peace of mind, JCB JSI 60/I90 cabs are available with an integral Rollover Protection Structure (ROPS). It's also easy to fit JCB's Falling Object Guard Structure (FOGS), thanks to standard fitment mounting brackets.

3 JCB's Safety Level Lock fully isolates hydraulic functions to avoid unintended movements. Our 2GO system means a JCB JSI 60/I90 can only be started in a safe locked position via two separate inputs.

4 JCB JSI 60/I90's have a large glass area and low hood line for superb visibility.

5 A JCB JSI 60/I90's steps and platforms have anti-slip punched steel plates for optimum grip, even in wet or icy conditions. Bolt-on plates have recessed bolts to reduce trip hazards.

6 Our standard rear view and optional side view camera display uninterrupted rear and sideways views on the smart controller display.

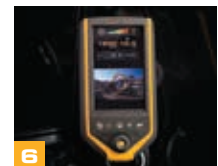

- 7** Your JS160/190 is equipped with a full set of side and rear view mirrors for all round visibility and safety compliance.
- 8** There's no need to climb onto the JS160/190 to check oil levels; all routine servicing can be done from ground level.
- 9** Optional safety rails protect operators from falls when they're on the upper structure of the JS160/190.
- 10** The JS160/190's optional beacons can improve on-site safety still further.
- 11** Choose LED work lights for an even better field of vision on the JS160/190.



LIVELINK, WORK SMARTER.

LIVELINK IS AN INNOVATIVE SOFTWARE SYSTEM THAT LETS YOU MANAGE JCB MACHINES REMOTELY – ONLINE, BY EMAIL OR BY MOBILE PHONE. ACCESS EVERYTHING FROM MACHINE ALERTS TO FUEL REPORTS AND HISTORY INFORMATION, WITH ALL DATA STORED AT A SECURE CENTER.

Productivity and cost benefits

By providing information like idle time monitoring and machine fuel consumption, JCB Livelink helps reduce your fuel usage, saving money and improving productivity. Machine location information can help improve efficiency and perhaps even reduce insurance costs.

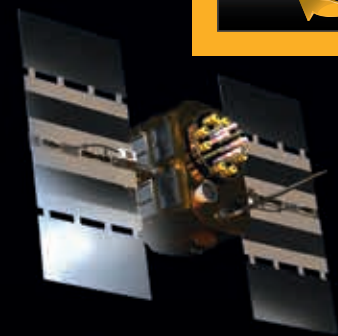

Maintenance benefits

Manage machine maintenance easily – accurate hours monitoring and service alerts improve maintenance planning, while real-time location data helps you manage your fleet. Critical machine alerts and maintenance history records are also available.



Security benefits

Livelink's real-time geofencing alerts tell you when machines move out of predetermined zones, and real-time curfew alerts inform you of unauthorized usage. Further benefits include real-time location information, advanced ECU matching (pairs Livelink with the immobilizer or ECU).



VALUE ADDED.

JCB'S WORLDWIDE CUSTOMER SUPPORT IS FIRST CLASS. WHATEVER YOU NEED AND WHEREVER YOU ARE, WE'LL BE AVAILABLE QUICKLY AND EFFICIENTLY TO HELP MAKE SURE YOUR MACHINERY IS PERFORMING TO ITS FULL POTENTIAL.



1 Our Technical Support Service provides instant access to factory expertise, day or night, while our Finance and Insurance teams are always on hand to provide fast, flexible, competitive quotes.

2 The global network of JCB Parts Centers is another model of efficiency; with 16 regional bases, we can deliver around 95% of all parts anywhere in the world within 24 hours. Our genuine JCB parts are designed to work in perfect harmony with your machine for optimum performance and productivity.



3 JCB Assetcare offers comprehensive extended warranties and service agreements, as well as service-only or repair and maintenance contracts. Irrespective of what you opt for, our maintenance teams around the world charge competitive labor rates, and offer non-obligation quotations as well as fast, efficient insurance repair work.

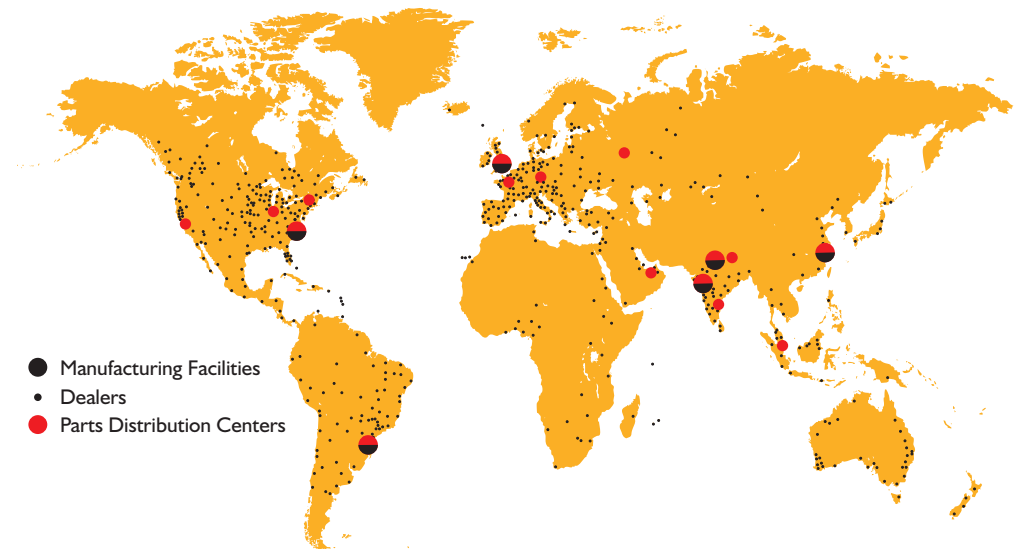

Note: JCB LIVELINK and JCB ASSETCARE may not be available in your region, so please check with your local dealer.

STATIC DIMENSIONS

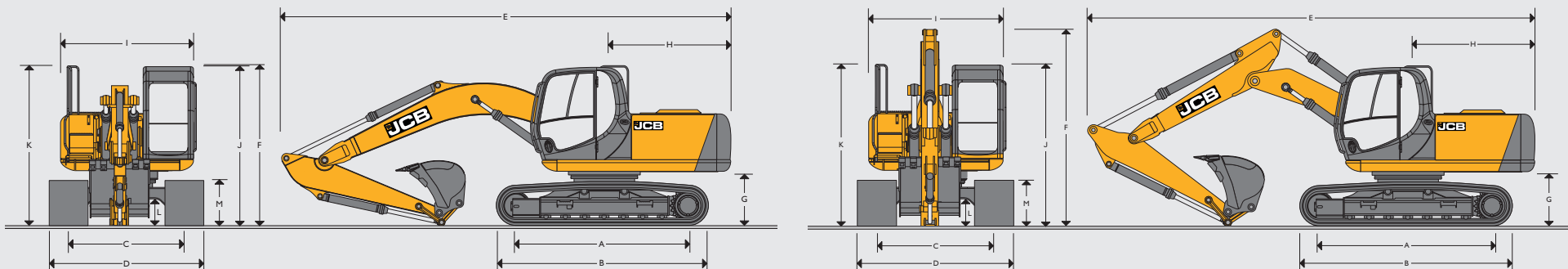

STATIC DIMENSIONS

Dimensions in ft-in (mm)	JS160						JS190					
	NLC			LC			NLC			LC		
A Track length on ground	10-2 (3090)			10-2 (3090)			11-0 (3370)			11-1 (3370)		
B Undercarriage overall length	12-11 (3940)			12-11 (3940)			13-8 (4170)			13-8 (4170)		
C Track gauge	6-6 (1990)			7-3 (2200)			6-6 (1990)			7-1 (2170)		
D Width over tracks 20in (500mm) trackshoes	8-2 (2490)			-			8-2 (2490)			-		
D Width over tracks 24in (600mm) trackshoes	8-6 (2590)			9-2 (2800)			8-6 (2590)			9-1 (2770)		
D Width over tracks 28in (700mm) trackshoes	8-10 (2690)			9-6 (2900)			8-10 (2690)			9-5 (2870)		
D Width over tracks 31in (800mm) trackshoes	-			9-10 (3000)			-			9-9 (2970)		
D Width over tracks 35in (900mm) trackshoes	-			10-2 (3100)			-			-		
Boom options	Monoboom 16-11 (5.15m)			T.A.B. 17-7 (5.35m)			Monoboom 16-11 (5.15m)			T.A.B. 17-7 (5.35m)		
Dipper lengths	7-5 (2.25m)	8-10 (2.7m)	9-10 (3.05m)	7-5 (2.25m)	8-10 (2.7m)	9-10 (3.05m)	7-5 (2.25m)	8-10 (2.7m)	9-10 (3.05m)	7-5 (2.25m)	8-10 (2.7m)	9-10 (3.05m)
E Transport length	27-4 (8338)	27-3 (8298)	27-6 (8388)	28-4 (8624)	28-4 (8646)	28-3 (8616)	27-5 (8366)	27-4 (8326)	27-7 (8415)	28-3 (8611)	28-5 (8666)	28-4 (8636)
F Transport height	9-10 (2992)	9-10 (2992)	9-10 (2992)	9-4 (2854)	8-12 (2738)	9-2 (2801)	9-11 (3014)	9-11 (3014)	9-11 (3014)	9-5 (2876)	9-1 (2760)	9-3 (2823)
Dimensions in ft-in (mm)												
G Counterweight clearance	3-5 (1050)						3-6 (1072)					
H Tailswing radius	7-8 (2338)						7-8 (2338)					
I Width of superstructure	8-1 (2470)						8-1 (2470)					
J Height over cab	9-9 (2965)						9-10 (2987)					
K Height over grab rail	9-10 (2992)						9-11 (3014)					
L Ground clearance	1-7 (470)						1-7 (486)					
M Track height	2-11 (880)						2-11 (885)					
Height with upperstructure safety rails	10-2 (3092)						10-3 (3114)					

ENGINE	
Model	JCB EcoMAX 444 TCA EU Stage IV EPA Tier 4 compliant
Type	4-stroke, 4-cylinder in-line, common rail, direct injection, turbocharged and intercooled diesel
Rated power (net)	125 hp (93 kW) at 2200rpm
Piston Displacement	4.4 litres
Air Filtration	Dry element with secondary safety element and in cab warning indicator
Starting system	24 volt
Batteries	2 x 12 volt
Alternator	24 volt 55 ampere

SWING SYSTEM	
Swing motor	Axial piston type
Swing brake	Hydraulic braking plus automatic spring applied disc type parking brake
Swing torque	7868 lbf
Swing speed	10.4 rpm
Swing gear	Large diameter, internally toothed fully sealed grease bath lubricated

UNDERCARRIAGE					
Carriage options	NLC – Narrow long carriage and LC – Long carriage				
Construction	Fully welded, 'X' frame type with central bellyguarding and sloping sidemembers with dirt relief holes under top rollers.				
Recovery point	Front and rear				
Track shoes	20in (500mm)	24in (600mm)	28in (700mm)	31in (800mm)	35in (900mm)
JS160 NLC (LC)	● (□)	● (□)	● (□)	● (□)	● (□)
JS190 NLC (LC)	●	● (□)	● (□)	(□)	
Upper & lower rollers	Heat treated, sealed and lubricated				
Track adjustment	Grease cylinder type				
Track idler	Sealed and lubricated, with spring cushioned recoil				
Track type	Sealed and lubricated				
Rollers and Shoes (each side)	JS160		JS190		
Track guides	1		2		
Lower rollers	7		7		
Upper rollers	2		2		
Track shoes	43		46		

● Triple grouser (NLC) □ Triple grouser (LC)

HYDRAULIC SYSTEM	
Open centered, negative control hydraulic system with twin variable flow piston pumps providing flow-on-demand	
Pumps	
Main pumps	2 variable displacement axial piston type
Maximum flow	2 x 43 g/min (2 x 164 l/min)
Servo pump	Gear type
Maximum flow	5.5 g/min (20.5 l/min)
Control valve	
A combined ten spool control valve with auxiliary service spool as standard	
Relief valve settings	
Boom/Arm/Bucket	4554 psi (314 bar)
With power boost	4975 psi (343 bar)
Swing circuit	4047 psi (279 bar)
Travel circuit	4975 psi (343 bar)
Pilot control	580 psi (40 bar)
Filtration	
In tank	150 micron, suction strainer
Main return line	10 micron, glass fibre element
Pilot line	10 micron, paper element
Hydraulic hammer return	10 micron, reinforced microform element

TRACK DRIVE			
Type	Fully hydrostatic, three speed with autoshift between high and medium speed		
Travel motors	Variable swash axial piston type, fully guarded within undercarriage frame		
Final drive	Planetary reduction, bolt-on sprockets		
Service brake	Hydraulic counter balance valve		
Park brake	Disc type, spring applied, automatic hydraulic release		
Gradeability	70% (35 deg) continuous		
Travel speed		JS160	JS190
	High	3.4 mp/h (5.5 kp/h)	2.6 mp/h (4.2 kp/h)
	Low	2.0 mp/h (3.2 kp/h)	1.5 mp/h (2.4 kp/h)
Tractive effort		37543 lbf	50243 lbf

SERVICE CAPACITIES			
Fuel tank	gal (lit)	58 (220)	
Engine coolant	gal (lit)	5.2 (19.7)	
Engine oil	gal (lit)	5.4 (20.4)	
Swing reduction gear	gal (lit)	1.6 (6)	
Track reduction gear (each side)	gal (lit)	1.2 (4.4)	
Hydraulic system	gal (lit)	37.5 (142)	
Hydraulic tank	gal (lit)	19.3 (73)	
DEF fluid capacity	gal (lit)	14.3 (54)	

WEIGHTS AND GROUND BEARING PRESSURES

		20in (500mm) shoes	24in (600mm) shoes	28in (700mm) shoes	31 in (800mm) shoes	35in (900mm) shoes
JSI 60 NLC/LC MONO – Machine equipped with a 6-11 (5.15m) Monoboom, 10-0 (3.05m) arm, 30ft ³ (0.85m ³) bucket, operator and full fuel tank.						
Machine weight	lb (kg)	37997 (17235)	38665 (17538)	39185 (17774)	39767 (18038)	40644 (18436)
Ground bearing pressure	lb/in ² (kg/cm ²)	8.0 (0.56)	6.7 (0.47)	5.8 (0.41)	5.1 (0.36)	4.7 (0.33)
JSI 60 NLC/LC T.A.B. – Machine equipped with a 17-7 (5.35m) T.A.B., 10-0 (3.05m) arm, 30ft ³ (0.85m ³) bucket, operator and full fuel tank.						
Machine weight	lb (kg)	39681 (17999)	40349 (18302)	40869 (18538)	41451 (18802)	42329 (19200)
Ground bearing pressure	lb/in ² (kg/cm ²)	8.2 (0.58)	7.0 (0.49)	6.4 (0.45)	5.4 (0.38)	4.8 (0.34)
JSI 90 NLC MONO – Machine equipped with a 6-11 (5.15m) Monoboom, 10-0 (3.05m) arm, 30ft ³ (0.85m ³) bucket, operator and full fuel tank.						
Machine weight	lb (kg)	43338 (19658)	43896 (19911)	-	-	-
Ground bearing pressure	lb/in ² (kg/cm ²)	8.2 (0.58)	7.0 (0.49)	-	-	-
JSI 90 LC MONO – Machine equipped with a 6-11 (5.15m) Monoboom, 10-0 (3.05m) arm, 30ft ³ (0.85m ³) bucket, operator and full fuel tank.						
Machine weight	lb (kg)	-	43345 (19661)	44527 (20197)	45109 (20461)	-
Ground bearing pressure	lb/in ² (kg/cm ²)	-	7.0 (0.49)	6.1 (0.43)	5.4 (0.38)	-
JSI 90 NLC T.A.B. – Machine equipped with a 17-7 (5.35m) T.A.B., 10-0 (3.05m) arm, 30ft ³ (0.85m ³) bucket, operator and full fuel tank.						
Machine weight	lb (kg)	45023 (20422)	45580 (20675)	-	-	-
Ground bearing pressure	lb/in ² (kg/cm ²)	8.5 (0.60)	7.3 (0.51)	-	-	-
JSI 90 LC T.A.B. – Machine equipped with a 17-7 (5.35m) T.A.B., 10-0 (3.05m) arm, 30ft ³ (0.85m ³) bucket, operator and full fuel tank.						
Machine weight	lb (kg)	-	45691 (20725)	46211 (20961)	46793 (21225)	-
Ground bearing pressure	lb/in ² (kg/cm ²)	-	7.3 (0.51)	6.3 (0.44)	5.5 (0.39)	-

BUCKET AND ARM COMBINATION - MONOBOOM

Bucket options		GP Bucket						HD Bucket			
Bucket width	ft-in (mm)	1-7 (450)	2-0 (600)	2-4 (700)	3-3 (1000)	3-11 (1200)	4-3 (1300)	2-0 (600)	3-3 (1000)	3-11 (1200)	4-3 (1300)
Bucket capacity	ft ³ (m ³)	8.8 (0.25)	13.4 (0.38)	14.8 (0.42)	24.7 (0.70)	32.1 (0.91)	34.7 (0.99)	13.4 (0.38)	24.7 (0.70)	32.1 (0.91)	34.7 (0.99)
Bucket weight	lb (kg)	906 (411)	988 (448)	1087 (493)	1272 (577)	1422 (645)	1484 (673)	974 (442)	1310 (594)	1488 (675)	1561 (708)
JS160 NLC											
7-5 (2.25m) Quickhitch (No Quickhitch)		☐ (☐)	☐ (☐)	☐ (☐)	■ (☐)	● (■)	● (■)	☐ (☐)	■ (☐)	● (■)	✕ (●)
8-10 (2.7m) Quickhitch (No Quickhitch)		☐ (☐)	☐ (☐)	☐ (☐)	■ (☐)	✕ (●)	✕ (●)	☐ (☐)	● (☐)	✕ (●)	✕ (●)
10-0 (3.05m) Quickhitch (No Quickhitch)		☐ (☐)	☐ (☐)	☐ (☐)	● (■)	✕ (●)	✕ (●)	☐ (☐)	● (■)	✕ (●)	✕ (✕)
JS160 LC											
7-5 (2.25m) Quickhitch (No Quickhitch)		☐ (☐)	☐ (☐)	☐ (☐)	☐ (☐)	■ (☐)	● (■)	☐ (☐)	☐ (☐)	■ (☐)	● (■)
8-10 (2.7m) Quickhitch (No Quickhitch)		☐ (☐)	☐ (☐)	☐ (☐)	☐ (☐)	● (■)	● (■)	☐ (☐)	■ (☐)	● (■)	● (■)
10-0 (3.05m) Quickhitch (No Quickhitch)		☐ (☐)	☐ (☐)	☐ (☐)	● (☐)	✕ (●)	✕ (●)	☐ (☐)	● (☐)	✕ (●)	✕ (●)
JS190 NLC											
7-5 (2.25m) Quickhitch (No Quickhitch)		☐ (☐)	☐ (☐)	☐ (☐)	☐ (☐)	■ (☐)	■ (☐)	☐ (☐)	☐ (☐)	■ (☐)	■ (☐)
8-10 (2.7m) Quickhitch (No Quickhitch)		☐ (☐)	☐ (☐)	☐ (☐)	☐ (☐)	■ (☐)	● (■)	☐ (☐)	☐ (☐)	■ (☐)	● (■)
10-0 (3.05m) Quickhitch (No Quickhitch)		☐ (☐)	☐ (☐)	☐ (☐)	■ (☐)	● (■)	✕ (●)	☐ (☐)	■ (☐)	✕ (●)	✕ (●)
JS190 LC											
7-5 (2.25m) Quickhitch (No Quickhitch)		☐ (☐)	☐ (☐)	☐ (☐)	☐ (☐)	☐ (☐)	☐ (☐)	☐ (☐)	☐ (☐)	☐ (☐)	■ (☐)
8-10 (2.7m) Quickhitch (No Quickhitch)		☐ (☐)	☐ (☐)	☐ (☐)	☐ (☐)	■ (☐)	● (■)	☐ (☐)	☐ (☐)	■ (☐)	● (■)
10-0 (3.05m) Quickhitch (No Quickhitch)		☐ (☐)	☐ (☐)	☐ (☐)	■ (☐)	● (■)	✕ (●)	☐ (☐)	■ (☐)	✕ (●)	✕ (●)

- ☐ = Suitable for general excavating (materials up to 112.4 lb/ft³).
- = Suitable for light excavating (materials up to 93.6 lb/ft³).
- = Suitable for grading & loading materials up to 74.9 lb/ft³.
- ✕ = Not warranted

These recommendations are given as a guide based on typical operating conditions.

WORKING RANGE - JS160 NLC/LC MONOBOOM I6-II (5.15M)

Arm length:		7-5 (2.25m)	8-10 (2.7m)	10-0 (3.05m)	
A	Maximum digging reach	ft-in (mm)	27-11 (8507)	29-3 (8908)	30-3 (9223)
B	Maximum digging reach (on ground)	ft-in (mm)	27-4 (8326)	28-8 (8735)	29-9 (9056)
C	Maximum digging depth	ft-in (mm)	18-0 (5482)	19-6 (5940)	20-7 (6286)
D	Maximum digging height	ft-in (mm)	29-0 (8863)	29-8 (9050)	30-3 (9219)
E	Maximum dumping height	ft-in (mm)	21-5 (6535)	22-1 (6726)	22-7 (6891)
F	Maximum vertical wall cut depth	ft-in (mm)	16-1 (4912)	17-7 (5370)	18-6 (5646)
G	Minimum swing radius	ft-in (mm)	9-10 (3000)	9-10 (3000)	9-10 (3000)
	Bucket rotation		182°	182°	182°
	Maximum dipper tearout	lbf	19289	16793	15444
	Maximum bucket tearout	lbf	26100	26100	26100

WORKING RANGE - JS190 NLC/LC MONOBOOM I6-II (5.15M)

Arm length:		7-5 (2.25m)	8-10 (2.7m)	10-0 (3.05m)	
A	Maximum digging reach	ft-in (mm)	27-11 (8514)	29-3 (8908)	30-3 (9223)
B	Maximum digging reach (on ground)	ft-in (mm)	27-5 (8368)	28-9 (8769)	29-10 (9088)
C	Maximum digging depth	ft-in (mm)	19-0 (5799)	20-6 (6252)	21-8 (6598)
D	Maximum digging height	ft-in (mm)	30-10 (9398)	31-8 (9663)	32-5 (9888)
E	Maximum dumping height	ft-in (mm)	23-1 (7048)	24-0 (7321)	24-9 (7543)
F	Maximum vertical wall cut depth	ft-in (mm)	17-2 (5229)	18-8 (5682)	19-9 (6028)
G	Minimum swing radius	ft-in (mm)	9-10 (3000)	9-10 (3000)	9-10 (3000)
	Bucket rotation		182°	182°	182°
	Maximum dipper tearout	lbf	19738	16793	15444
	Maximum bucket tearout	lbf	26100	26100	26100

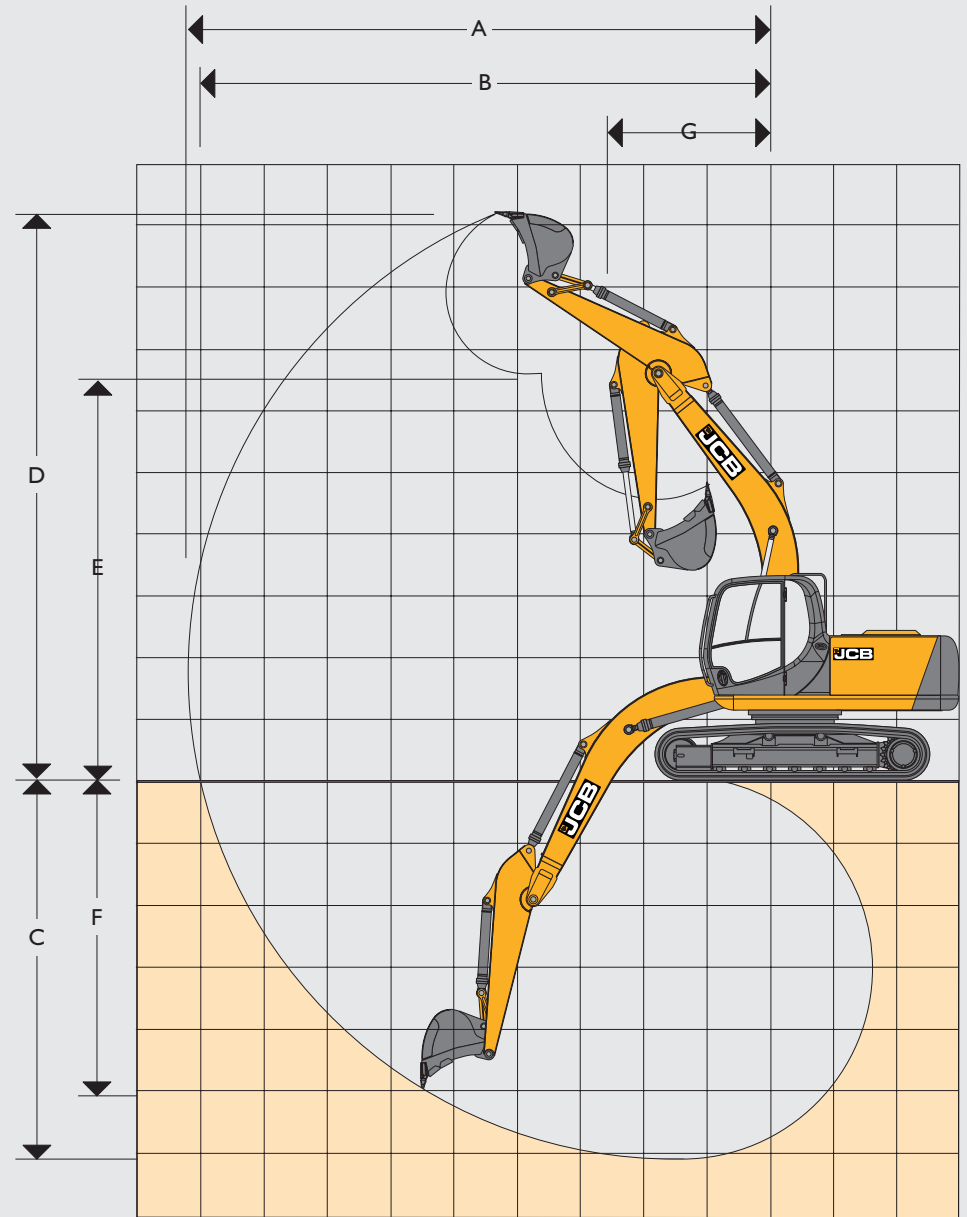

WORKING RANGE - JS160 NLC/LC T.A.B. 17-7 (5.35M)







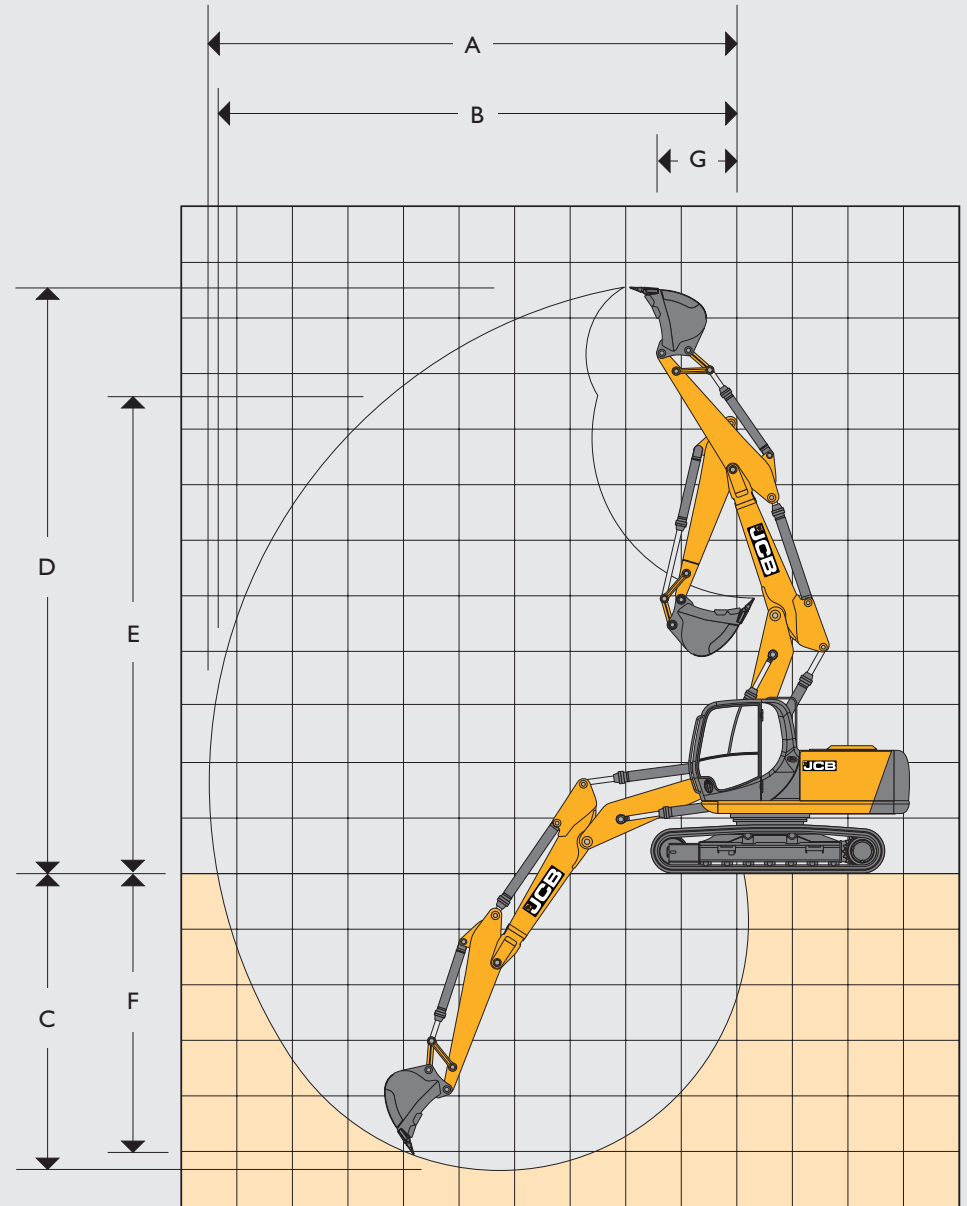





Arm length:		7-5 (2.25m)	8-10 (2.7m)	10-0 (3.05m)	
A	Maximum digging reach	ft-in (mm)	29-0 (8831)	30-5 (9260)	31-6 (9592)
B	Maximum digging reach (on ground)	ft-in (mm)	28-5 (8652)	29-10 (9094)	31-1 (9463)
C	Maximum digging depth	ft-in (mm)	17-8 (5376)	19-1 (5808)	20-1 (6130)
D	Maximum digging height	ft-in (mm)	33-7 (10226)	34-11 (10652)	35-5 (10800)
E	Maximum dumping height	ft-in (mm)	26-2 (7976)	27-5 (8366)	28-5 (8667)
F	Maximum vertical wall cut depth	ft-in (mm)	13-11 (4254)	15-6 (4721)	17-2 (5233)
G	Minimum swing radius	ft-in (mm)	7-1 (2170)	7-4 (2227)	8-6 (2587)
	Bucket rotation		182°	182°	182°
	Maximum dipper tearout	lbf	19289	16793	15444
	Maximum bucket tearout	lbf	26100	26100	26100

WORKING RANGE - JS190 NLC/LC T.A.B. 17-7 (5.35M)













Arm length:		7-5 (2.25m)	8-10 (2.7m)	10-0 (3.05m)	
A	Maximum digging reach	ft-in (mm)	29-0 (8831)	30-5 (9260)	31-6 (9592)
B	Maximum digging reach (on ground)	ft-in (mm)	28-5 (8652)	29-10 (9094)	31-0 (9463)
C	Maximum digging depth	ft-in (mm)	17-7 (5354)	19-0 (5786)	20-0 (6108)
D	Maximum digging height	ft-in (mm)	33-7 (10248)	35-0 (10674)	35-6 (10822)
E	Maximum dumping height	ft-in (mm)	26-3 (8000)	27-8 (8444)	28-5 (8672)
F	Maximum vertical wall cut depth	ft-in (mm)	13-11 (4232)	15-5 (4699)	17-1 (5211)
G	Minimum swing radius	ft-in (mm)	8-6 (2587)	7-4 (2227)	8-6 (2587)
	Bucket rotation		182°	182°	182°
	Maximum dipper tearout	lbf	19289	16793	15444
	Maximum bucket tearout	lbf	26100	26100	26100















LIFT CAPACITIES – ARM LENGTH: 7-5 (2.25M), 16-II (5.15M) MONOBOOM, TRACKSHOES: 28IN (700MM), NO BUCKET. JS160 LC MONO

Reach	4-11 (1.5m)		9-10 (3m)		14-9 (4.5m)		19-8 (6m)		24-7 (7.5m)		Capacity at Max Reach		ft-in (mm)	
														
Load Point Ht.	lb (kg)	lb (kg)	lb (kg)	lb (kg)	lb (kg)	lb (kg)	lb (kg)	lb (kg)	lb (kg)	lb (kg)	lb (kg)	lb (kg)		
24-7 (7.5m)												8554* (3880*)	8554* (3880*)	14-7 (4495)
19-8 (6m)												7363* (3340*)	7363* (3340*)	19-6 (5961)
14-9 (4.5m)					12191* (5530*)	12191* (5530*)	11023 (5000)	8069 (3660)				7033* (3190*)	6592 (2990)	22-3 (6797)
9-10 (3m)					15212* (6900*)	11817 (5360)	10736 (4870)	7782 (3530)				7099* (3220*)	5886 (2670)	23-7 (7230)
4-11 (1.5m)					16005 (7260)	11155 (5060)	10406 (4720)	7496 (3400)				7562* (3430*)	5644 (2560)	24-1 (7331)
0 (0m)			11618* (5270*)	11618* (5270*)	15587 (7070)	10803 (4900)	10185 (4620)	7275 (3300)				8025 (3640)	5798 (2630)	23-3 (7116)
- 4-11 (- 1.5m)	13161* (5970*)	13161* (5970*)	23611* (10710*)	20194 (9160)	15498 (7030)	10714 (4860)	10119 (4590)	7231 (3280)				8995 (4080)	6459 (2930)	21-5 (6554)
- 9-10 (- 3m)			23788* (10790*)	20569 (9330)	15697 (7120)	10891 (4940)						11574 (5250)	8245 (3740)	18-2 (5535)

LIFT CAPACITIES – ARM LENGTH: 8-10 (2.7M), 16-II (5.15M) MONOBOOM, TRACKSHOES: 28IN (700MM), NO BUCKET. JS160 LC MONO

Reach	4-11 (1.5m)		9-10 (3m)		14-9 (4.5m)		19-8 (6m)		24-7 (7.5m)		Capacity at Max Reach		ft-in (mm)	
														
Load Point Ht.	lb (kg)	lb (kg)	lb (kg)	lb (kg)	lb (kg)	lb (kg)	lb (kg)	lb (kg)	lb (kg)	lb (kg)	lb (kg)	lb (kg)		
24-7 (7.5m)												6217* (2820*)	6217* (2820*)	16-8 (5128)
19-8 (6m)							8466* (3840*)	8267 (3750)				5512* (2500*)	5512* (2500*)	21-2 (6449)
14-9 (4.5m)					10979* (4980*)	10979* (4980*)	10163* (4610*)	8135 (3690)				5313* (2410*)	5313 (2410)	23-7 (7228)
9-10 (3m)			21230* (9630*)	21230* (9630*)	14043* (6370*)	11993 (5440)	10780 (4890)	7826 (3550)	7033* (3190*)	5578 (2530)		5379* (2440*)	5379 (2440*)	25-1 (7636)
4-11 (1.5m)			11155* (5060*)	11155* (5060*)	16094 (7300)	11243 (5100)	10428 (4730)	7496 (3400)	7496 (3400)	5423 (2460)		5732* (2600*)	5181 (2350)	25-4 (7732)
0 (0m)			14087* (6390*)	14087* (6390*)	15587 (7070)	10780 (4890)	10141 (4600)	7231 (3280)	6944 *(3150*)	5335 (2420)		6393* (2900*)	5313 (2410)	24-7 (7529)
- 4-11 (- 1.5m)	12676* (5750*)	12676* (5750*)	22200* (10070*)	19974 (9060)	15410 (6990)	10604 (4810)	10031 (4550)	7121 (3230)				7716* (3500*)	5820 (2640)	23-0 (7000)
- 9-10 (- 3m)	21583* (9790*)	21583* (9790*)	25573* (11600*)	20260 (9190)	15498 (7030)	10714 (4860)	10141 (4600)	7253 (3290)				10031 (4550)	7165 (3250)	19-9 (6058)
- 14-9 (- 4.5m)			18673* (8470*)	18673* (8470*)								12324* (5590*)	11398 (5170)	14-6 (4443)

LIFT CAPACITIES – ARM LENGTH: 10-0 (3.05M), 16-II (5.15M) MONOBOOM, TRACKSHOES: 28IN (700MM), NO BUCKET. JS160 LC MONO

Reach	4-11 (1.5m)		9-10 (3m)		14-9 (4.5m)		19-8 (6m)		24-7 (7.5m)		Capacity at Max Reach		ft-in (mm)	
														
Load Point Ht.	lb (kg)	lb (kg)	lb (kg)	lb (kg)	lb (kg)	lb (kg)	lb (kg)	lb (kg)	lb (kg)	lb (kg)	lb (kg)	lb (kg)		
24-7 (7.5m)												5379* (2440*)	5379* (2440*)	18-7 (5707)
19-8 (6m)							8554* (3880*)	8289 (3760)				4762* (2160*)	4762* (2160*)	22-7 (6916)
14-9 (4.5m)							9392* (4260*)	8113 (3680)	5930* (2690*)	5600 (2540)		4564* (2070*)	4564* (2070*)	25-1 (7647)
9-10 (3m)			18739* (8500*)	18739* (8500*)	12963* (5880*)	11993 (5440)	10736* (4870*)	7760 (3520)	7562 (3430)	5489 (2490)		4564* (2070*)	4564* (2070*)	26-4 (8033)
4-11 (1.5m)			13404* (6080*)	13404* (6080*)	16027 (7270)	11155 (5060)	10318 (4680)	7385 (3350)	7385 (3350)	5313 (2410)		4784* (2170*)	4696 (2130)	26-7 (8124)
0 (0m)			13536* (6140*)	13536* (6140*)	15388 (6980)	10582 (4800)	9987 (4530)	7077 (3210)	7231 (3280)	5181 (2350)		5247* (2380*)	4784 (2170)	26-0 (7931)
- 4-11 (- 1.5m)	10780* (4890*)	10780* (4890*)	19885* (9020*)	19885 (8850)	15146 (6870)	10362 (4700)	9833 (4460)	6922 (3140)				6129* (2780*)	5203 (2360)	24-4 (7431)
- 9-10 (- 3m)	18497* (8390*)	18497* (8390*)	26389* (11970*)	26389 (8960)	15190 (6890)	10406 (4720)	9877 (4480)	6989 (3170)				7959* (3610*)	6239 (2830)	21-5 (6553)
- 14-9 (- 4.5m)			20591* (9340*)	20591 (9250)	13955 (6330*)	10780 (4890)						11376* (5160*)	9105 (4130)	16-7 (5101)



























Lift capacity front and rear.















Lift capacity full circle.

- Notes:**
1. The above loads are in compliance with SAE and ISO Hydraulic Excavator Lift Capacity Standards.
 2. They do not exceed 87% of hydraulic lifting capacity or 75% of tipping load.
 3. Rated loads marked with an asterisk (*) are limited by hydraulic capacity rather than tipping load.

LIFT CAPACITIES – ARM LENGTH: 7-5 (2.25M), 16-II (5.15M) MONOBOOM, TRACKSHOES: 20IN (500MM), NO BUCKET.													JSI60 NLC MONO	
Reach	4-11 (1.5m)		9-10 (3m)		14-9 (4.5m)		19-8 (6m)		24-7 (7.5m)		Capacity at Max Reach		ft-in (mm)	
														
Load Point Ht.	lb (kg)	lb (kg)	lb (kg)	lb (kg)	lb (kg)	lb (kg)	lb (kg)	lb (kg)	lb (kg)	lb (kg)	lb (kg)	lb (kg)		
24-7 (7.5m)												8554* (3880*)	8554* (3880*)	14-7 (4495)
19-8 (6m)												7363* (3340*)	7231 (3280)	19-6 (5961)
14-9 (4.5m)					12191* (5530*)	11023 (5000)	10714 (4860)	7099 (3220)				7033* (3190*)	5776 (2620)	22-3 (6797)
9-10 (3m)					15212* (6900*)	10318 (4680)	10406 (4720)	6834 (3100)				7121* (3230*)	4916 (2230)	23-7 (7230)
4-11 (1.5m)					15520 (7040)	9656 (4380)	10097 (4580)	6526 (2960)				7518 (3410)	4916 (2230)	24-1 (7331)
0 (0m)			11618* (5270*)	11618* (5270*)	15102 (6850)	9325 (4230)	9855 (4470)	6327 (2870)				7760 (3520)	5049 (2290)	23-3 (7116)
- 4-11 (- 1.5m)	13161* (5970*)	13161* (5970*)	23611* (10710*)	17064 (7740)	15035 (6820)	9237 (4190)	9810 (4450)	6283 (2850)				8708 (3950)	5622 (2550)	21-5 (6554)
- 9-10 (- 3m)			23788* (10790*)	17394 (7890)	15234 (6910)	9414 (4270)						11221 (5090)	7165 (3250)	18-2 (5535)

LIFT CAPACITIES – ARM LENGTH: 8-10 (2.7M), 16-II (5.15M) MONOBOOM, TRACKSHOES: 20IN (500MM), NO BUCKET.													JSI60 NLC MONO	
Reach	4-11 (1.5m)		9-10 (3m)		14-9 (4.5m)		19-8 (6m)		24-7 (7.5m)		Capacity at Max Reach		ft-in (mm)	
														
Load Point Ht.	lb (kg)	lb (kg)	lb (kg)	lb (kg)	lb (kg)	lb (kg)	lb (kg)	lb (kg)	lb (kg)	lb (kg)	lb (kg)	lb (kg)		
24-7 (7.5m)												6217* (2820*)	6217* (2820*)	16-8 (5128)
19-8 (6m)							8466* (3840*)	7297 (3310)				5512* (2500*)	5512* (2500*)	21-2 (6449)
14-9 (4.5m)							10163* (4610*)	7165 (3250)				5313* (2410*)	5269 (2390)	23-7 (7228)
9-10 (3m)			21230* (9630*)	19224* (8720*)	17593* (7980*)	10979 (4980)	10472 (4750)	6856 (3110)	7033* (3190*)	4872 (2210)	5379* (2440*)	4718 (2140)	25-1 (7636)	
4-11 (1.5m)			11155* (5060*)	11155* (5060*)	14043 (6370)	10472 (4750)	10097 (4580)	6526 (2960)	7253 (3290)	4740 (2150)	5732* (2600*)	4519 (2050)	25-4 (7732)	
0 (0m)			14087* (6390*)	14087* (6390*)	15631 (7090)	9744 (4420)	9833 (4460)	6283 (2850)	6944* (3150*)	4630 (2100)	6393* (2900*)	4608 (2090)	24-7 (7529)	
- 4-11 (- 1.5m)	12676* (5750*)	12676* (5750*)	22200* (10070*)	16821 (7630)	15102 (6850)	9281 (4210)	9722 (4410)	9173 (2800)				7716* (3500*)	5071 (2300)	23-0 (7000)
- 9-10 (- 3m)	21583* (9790*)	21583* (9790*)	25573* (11600*)	17108 (7760)	14925 (6770)	9149 (4150)	9833 (4460)	6283 (2850)				9700 (4400)	6217 (2820)	19-9 (6058)
- 14-9 (- 4.5m)			18673* (8470*)	17747 (8050)	15035 (6820*)	9237 (4190)						12324* (5590*)	9877 (4480)	14-6 (4443)











LIFT CAPACITIES – ARM LENGTH: 10-0 (3.05M), 16-II (5.15M) MONOBOOM, TRACKSHOES: 20IN (500MM), NO BUCKET.													JSI60 NLC MONO	
Reach	4-11 (1.5m)		9-10 (3m)		14-9 (4.5m)		19-8 (6m)		24-7 (7.5m)		Capacity at Max Reach		ft-in (mm)	
														
Load Point Ht.	lb (kg)	lb (kg)	lb (kg)	lb (kg)	lb (kg)	lb (kg)	lb (kg)	lb (kg)	lb (kg)	lb (kg)	lb (kg)	lb (kg)		
24-7 (7.5m)												5379* (2440*)	5379* (2440*)	18-7 (5707)
19-8 (6m)							8554* (3880*)	7297 (3310)				4762* (2160*)	4762* (2160*)	22-7 (6916)
14-9 (4.5m)							9392* (4260*)	7143 (3240)	5930* (2690*)	4894 (2220)	4564* (2070*)	4564* (2070*)	25-1 (7647)	
9-10 (3m)			18739* (8500*)	18739* (8500*)	12963* (5880*)	10472 (4750)	10406 (4720)	6790 (3080)	7319 (3320)	4784 (2170)	4564* (2070*)	4233 (1920)	26-4 (8033)	
4-11 (1.5m)			13404* (6080*)	13404* (6080*)	15542 (7050)	9634 (4370)	9987 (4530)	6415 (2910)	7143 (3240)	4608 (2090)	4784* (2170*)	4056 (1840)	26-7 (8124)	
0 (0m)			13536* (6140*)	13536* (6140*)	14925 (6770)	9105 (4130)	9678 (4390)	6107 (2770)	6989 (3170)	4475 (2030)	5247* (2380*)	4123 (1870)	26-0 (7931)	
- 4-11 (- 1.5m)	10780* (4890*)	10780* (4890*)	19885* (9020*)	16380 (7430)	14661 (6650)	8885 (4030)	9502 (4310)	5974 (2710)				6129* (2780*)	4497 (2040)	24-4 (7431)
- 9-10 (- 3m)	18497* (8390*)	18497* (8390*)	26389* (11970*)	16601 (7530)	14705 (6670)	8929 (4050)	16182 (7340)	6019 (2730)				7959* (3610*)	5401 (2450)	21-5 (6553)
- 14-9 (- 4.5m)			20591* (9340*)	17218 (7810)	13955* (6330*)	9303 (4220)						11376* (5160*)	7892 (3580)	16-7 (5101)













Notes:

- The above loads are in compliance with SAE and ISO Hydraulic Excavator Lift Capacity Standards.
- They do not exceed 87% of hydraulic lifting capacity or 75% of tipping load.
- Rated loads marked with an asterisk (*) are limited by hydraulic capacity rather than tipping load.











LIFT CAPACITIES – ARM LENGTH: 7-5 (2.25M), 17-7 (5.35M) T.A.B., TRACKSHOES: 28IN (700MM), NO BUCKET. JSI60 LC T.A.B.

Reach	9-10 (3m)		14-9 (4.5m)		19-8 (6m)		24-7 (7.5m)		Capacity at Max Reach		ft-in (mm)
											
Load Point Ht.	lb (kg)	lb (kg)	lb (kg)	lb (kg)	lb (kg)	lb (kg)	lb (kg)	lb (kg)	lb (kg)	lb (kg)	
29-6 (9m)									15961* (7240*)	15961* (7240*)	7-3 (2218)
24-7 (7.5m)	13073* (5930*)	13079* (5930*)	12743* (5780*)	12743* (5780*)					9171* (4160*)	9171* (4160*)	16-4 (5009)
19-8 (6m)	11089* (5030*)	11089* (5030*)	12853* (5830*)	12853* (5830*)	11111 (5040)	8047 (3650)			7716* (3500*)	7209 (3270)	20-9 (6356)
14-9 (4.5m)	18717* (8490*)	18717* (8490*)	15785* (7160*)	12368 (5610)	10957 (4970)	7892 (3580)			7165* (3250*)	5886 (2670)	23-4 (7145)
9-10 (3m)			16512 (7490)	11464 (5200)	10582 (4800)	7562 (3430)	7496 (3400)	5357 (2430)	7033* (3190*)	5291 (2400)	24-8 (7557)
4-11 (1.5m)			15653 (7100)	10714 (4860)	10207 (4630)	7209 (3270)	7385 (3350)	5247 (2380)	7165 (3250)	5093 (2310)	25-1 (7654)
0 (0m)			15256 (6920)	10362 (4700)	9965 (4520)	6989 (3170)			7407 (3360)	5247 (2380)	24-4 (7449)
- 4-11 (- 1.5m)	16711* (7580*)	16711* (7580*)	14925* (6770*)	10362 (4700)	9943 (4510)	6967 (3160)			7848* (3560*)	5864 (2660)	22-7 (6914)

LIFT CAPACITIES – ARM LENGTH: 8-10 (2.7M), 17-7 (5.35M) T.A.B., TRACKSHOES: 28IN (700MM), NO BUCKET. JSI60 LC T.A.B.

Reach	9-10 (3m)		14-9 (4.5m)		19-8 (6m)		24-7 (7.5m)		Capacity at Max Reach		ft-in (mm)
											
Load Point Ht.	lb (kg)	lb (kg)	lb (kg)	lb (kg)	lb (kg)	lb (kg)	lb (kg)	lb (kg)	lb (kg)	lb (kg)	
29-6 (9m)	11817* (5360*)	11817* (5360*)							9392* (4260*)	9392* (4260*)	11-3 (3449)
24-7 (7.5m)			10538* (4780*)	10538* (4780*)					6592* (2990*)	6592* (2990*)	18-5 (5649)
19-8 (6m)			10251* (4650*)	10251* (4650*)	10097* (4580*)	8201 (3720)			5710* (2590*)	5710* (2590*)	22-5 (6869)
14-9 (4.5m)	11332* (5140*)	11332* (5140*)	12125* (5500*)	12125* (5500*)	11067 (5020)	8003 (3630)	6900* (3130*)	5489 (2490)	5379* (2440*)	5335 (2420)	24-9 (7604)
9-10 (3m)			16733 (7590)	11684 (5300)	10648 (4830)	7606 (3450)	7540 (3420)	5401 (2450)	5313* (2410*)	4850 (2200)	26-2 (7992)
4-11 (1.5m)			15763 (7150)	10803 (4900)	10229 (4640)	7209 (3270)	7363 (3340)	5225 (2370)	5467 (2480)	4674 (2120)	26-5 (8084)
0 (0m)			15234 (6910)	10340 (4690)	9921 (4500)	6944 (3150)	7231 (3280)	5115 (2320)	5886* (2670*)	4784 (2170)	25-9 (7890)
- 4-11 (- 1.5m)	16380* (7430*)	16380* (7430*)	15102 (6850)	10229 (4640)	9833 (4460)	6856 (3110)			6680* (3030*)	5269 (2390)	24-2 (7388)
- 9-10 (- 3m)			11486* (5210*)	10406 (4720)	7915* (3590*)	7011 (3180)			6967* (3160*)	6658 (3020)	20-6 (6264)

LIFT CAPACITIES – ARM LENGTH: 10-0 (3.05M), 17-7 (5.35M) T.A.B., TRACKSHOES: 28IN (700MM), NO BUCKET. JSI60 LC T.A.B.

Reach	9-10 (3m)		14-9 (4.5m)		19-8 (6m)		24-7 (7.5m)		Capacity at Max Reach		ft-in (mm)
											
Load Point Ht.	lb (kg)	lb (kg)	lb (kg)	lb (kg)	lb (kg)	lb (kg)	lb (kg)	lb (kg)	lb (kg)	lb (kg)	
29-6 (9m)	11243* (5100*)	11243* (5100*)							7826* (3550*)	7826* (3550*)	14-0 (4269)
24-7 (7.5m)			9237* (4190*)	9237* (4190*)	7430* (3370*)	7430* (3370*)			5754* (2610*)	5754* (2610*)	20-3 (6178)
19-8 (6m)			8444* (3830*)	8444* (3830*)	9083* (4120*)	8223 (3730)			4982* (2260*)	4982* (2260*)	24-0 (7309)
14-9 (4.5m)	6922* (3140*)	6922* (3140*)	9348* (4240*)	9348* (4240*)	9921* (4500*)	7981 (3620)	7628 (3460)	5467 (2480)	4674* (2120*)	4674* (2120*)	26-3 (8003)
9-10 (3m)			16799 (7620)	11706 (5310)	10604 (4810)	7562 (3430)	7452 (3380)	5313 (2410)	4586* (2080*)	4365 (1980)	27-5 (8372)
4-11 (1.5m)			15697 (7120)	10736 (4870)	10119 (4590)	7099 (3220)	7231 (3280)	5115 (2320)	4652* (2110*)	4233 (1920)	27-8 (8460)
0 (0m)			15035 (6820)	10119 (4590)	9766 (4430)	6768 (3070)	7077 (3210)	4960 (2250)	4916* (2230*)	4321 (1960)	27-1 (8275)
- 4-11 (- 1.5m)	14330* (6500*)	14330* (6500*)	14815 (6720)	9943 (4510)	9612 (4360)	6636 (3010)	7055 (3200)	4938 (2240)	5467* (2480*)	4718 (2140)	25-6 (7798)
- 9-10 (- 3m)	15564* (7060*)	15564* (7060*)	12478* (5660*)	10053 (4560)	8973* (4070*)	6724 (3050)			6085* (2760*)	5710 (2590)	22-5 (6857)













Lift capacity front and rear.











Notes:











- The above loads are in compliance with SAE and ISO Hydraulic Excavator Lift Capacity Standards.
- They do not exceed 87% of hydraulic lifting capacity or 75% of tipping load.
- Rated loads marked with an asterisk (*) are limited by hydraulic capacity rather than tipping load.



Lift capacity full circle.

LIFT CAPACITIES – ARM LENGTH: 7-5 (2.25M), 17-7 (5.35M) T.A.B., TRACKSHOES: 20IN (500MM), NO BUCKET.											JSI60 NLC T.A.B.
Reach	9-10 (3m)		14-9 (4.5m)		19-8 (6m)		24-7 (7.5m)		Capacity at Max Reach		ft-in (mm)
											
Load Point Ht.	lb (kg)	lb (kg)	lb (kg)	lb (kg)	lb (kg)	lb (kg)	lb (kg)	lb (kg)	lb (kg)	lb (kg)	
29-6 (9m)									15961* (7240*)	15961* (7240*)	7-3 (2218)
24-7 (7.5m)	13073* (5930*)	13073* (5930*)	12743* (5780*)	11354 (5150)					9171* (4160*)	9171* (4160*)	16-4 (5009)
19-8 (6m)	11089* (5030*)	11089* (5030*)	12853* (5830*)	11376 (5160)	10780 (4890)	7055 (3200)			7716* (3500*)	6305 (2860)	20-9 (6356)
14-9 (4.5m)	18717* (8490*)	18717* (8490*)	15785* (7160*)	10803 (4900)	10626 (4820)	6900 (3130)			7165* (3250*)	5115 (2320)	23-4 (7145)
9-10 (3m)			16027 (7270)	9943 (4510)	10251 (4650)	6570 (2980)	7253 (3290)	4652 (2110)	7033* (3190*)	4586 (2080)	24-8 (7557)
4-11 (1.5m)			15168 (6880)	9193 (4170)	10758 (4880)	6239 (2830)	7143 (3240)	4541 (2060)	6922 (3140)	4409 (2000)	25-1 (7654)
0 (0m)			14771 (6700)	8862 (4020)	9656 (4380)	6019 (2730)			7165 (3250)	4541 (2060)	24-4 (7449)
- 4-11 (- 1.5m)	16711* (7580*)	16535* (7500*)	14771 (6700)	8840 (4010)	9634 (4370)	5997 (2720)			7848* (3560*)	5049 (2290)	22-7 (6914)

LIFT CAPACITIES – ARM LENGTH: 8-10 (2.7M), 17-7 (5.35M) T.A.B., TRACKSHOES: 20IN (500MM), NO BUCKET.											JSI60 NLC T.A.B.
Reach	9-10 (3m)		14-9 (4.5m)		19-8 (6m)		24-7 (7.5m)		Capacity at Max Reach		ft-in (mm)
											
Load Point Ht.	lb (kg)	lb (kg)	lb (kg)	lb (kg)	lb (kg)	lb (kg)	lb (kg)	lb (kg)	lb (kg)	lb (kg)	
29-6 (9m)	11817* (5360*)	11817* (5360*)							9392* (4260*)	9392* (4260*)	11-3 (3449)
24-7 (7.5m)			10538* (4780*)	10538* (4780*)					6592* (2990*)	6592* (2990*)	18-5 (5649)
19-8 (6m)			10251* (4650*)	10251* (4650*)	10097* (4580*)	7209 (3270)			5710* (2590*)	5600 (2540)	22-5 (6869)
14-9 (4.5m)	11332* (5140*)	11332* (5140*)	12125* (5500*)	11023 (5000)	10736 (4870)	7011 (3180)	6900* (3130*)	5379 (2170)	5379* (2440*)	4630 (2100)	24-9 (7604)
9-10 (3m)			16270 (7380)	10119 (4590)	10340 (4690)	6636 (3010)	7297 (3310)	4674 (2120)	5313* (2410*)	4189 (1900)	26-2 (7992)
4-11 (1.5m)			15278 (6930)	9281 (4210)	9899 (4490)	6239 (2830)	7121 (3230)	4519 (2050)	5467* (2480*)	4012 (1820)	26-5 (8084)
0 (0m)			14749 (6690)	8818 (4000)	9612 (4360)	5974 (2710)	7011 (3180)	4409 (2000)	5886* (2670*)	4123 (1870)	25-9 (7890)
- 4-11 (- 1.5m)	16380* (7430*)	16204 (7350)	14639 (6640)	8730 (3960)	9524 (4320)	5886 (2670)			6680* (3030*)	4541 (2060)	24-2 (7388)
- 9-10 (- 3m)			11486* (5210*)	8885 (4030)	7915* (3590*)	6041 (2740)			6967* (3160*)	5732 (2600)	20-6 (6264)

LIFT CAPACITIES – ARM LENGTH: 10-0 (3.05M), 17-7 (5.35M) T.A.B., TRACKSHOES: 20 IN (500MM), NO BUCKET.											JSI60 NLC T.A.B.
Reach	9-10 (3m)		14-9 (4.5m)		19-8 (6m)		24-7 (7.5m)		Capacity at Max Reach		ft-in (mm)
											
Load Point Ht.	lb (kg)	lb (kg)	lb (kg)	lb (kg)	lb (kg)	lb (kg)	lb (kg)	lb (kg)	lb (kg)	lb (kg)	
29-6 (9m)	11243* (5100*)	11243* (5100*)							7826* (3550*)	7826* (3550*)	14-0 (4269)
24-7 (7.5m)			9237* (4190*)	9237* (4190*)	7430* (3370*)	7077 (3210)			5754* (2610*)	5754* (2610*)	20-3 (6178)
19-8 (6m)			8444* (3830*)	8444* (3830*)	9083* (4120*)	7231 (3280)			4982* (2260*)	4938 (2240)	24-0 (7309)
14-9 (4.5m)	7518* (3410*)	7518* (3410*)	9348* (4240*)	9348* (4240*)	9921* (4500*)	6989 (3170)	7385 (3350)	4740 (2150)	4674* (2120*)	4145 (1880)	26-3 (8003)
9-10 (3m)			16314 (7400)	10141 (4600)	10295 (4670)	6570 (2980)	7209 (3270)	4586 (2080)	4586* (2080*)	3748 (1700)	27-5 (8372)
4-11 (1.5m)			15234 (6910)	9215 (4180)	9810 (4450)	6129 (2780)	7011 (3180)	4387 (1990)	4652* (2110*)	3616 (1640)	27-8 (8460)
0 (0m)			14550 (6600)	8620 (3910)	9436 (4280)	5798 (2630)	6834 (3100)	4233 (1920)	4916* (2230*)	3704 (1680)	27-1 (8275)
- 4-11 (- 1.5m)	14330* (6500*)	14330* (6500*)	14352 (6510)	8444 (3830)	9281 (4210)	5666 (2570)	6812 (3090)	4211 (1910)	5467* (2480*)	4034 (1830)	25-6 (7798)
- 9-10 (- 3m)	15564* (7060*)	15564* (7060*)	12478* (5660*)	8554 (3880)	8973* (4070*)	5754 (2610)			6085* (2760*)	4916 (2230)	22-5 (6857)



Lift capacity front and rear.













Notes:

1. The above loads are in compliance with SAE and ISO Hydraulic Excavator Lift Capacity Standards.
2. They do not exceed 87% of hydraulic lifting capacity or 75% of tipping load.
3. Rated loads marked with an asterisk (*) are limited by hydraulic capacity rather than tipping load.















Lift capacity full circle.









LIFT CAPACITIES – ARM LENGTH: 7-5 (2.25M), 16-II (5.15M) MONOBOOM, TRACKSHOES: 28IN (700MM), NO BUCKET. JS190 LC MONO

Reach	4-11 (1.5m)		9-10 (3m)		14-9 (4.5m)		19-8 (6m)		24-7 (7.5m)		Capacity at Max Reach			
														
Load Point Ht.	lb (kg)	lb (kg)	lb (kg)	lb (kg)	lb (kg)	lb (kg)	lb (kg)	lb (kg)	lb (kg)	lb (kg)	lb (kg)	lb (kg)	ft-in (mm)	
24-7 (7.5m)												8598* (3900*)	8598* (3900*)	14-7 (4484)
19-8 (6m)												7385* (3350*)	7385* (3350*)	19-5 (5956)
14-9 (4.5m)					12169* (5520*)	12169* (5520*)	11023* (5000*)	9325 (4230)				7055* (3200*)	7055* (3200*)	22-3 (6795)
9-10 (3m)					15168* (6880*)	13602 (6170)	12191* (5530*)	9039 (4100)				7121* (3230*)	6900 (3130)	23-7 (7230)
4-11 (1.5m)					18056* (8190*)	12941 (5870)	13514 (6130)	8752 (3970)				7540* (3420*)	6636 (3010)	24-1 (7334)
0 (0m)			11574* (5250*)	11574* (5250*)	19467* (8830*)	12588 (5710)	13272 (6020)	8532 (3870)				8444* (3830*)	6834 (3100)	23-4 (7122)
- 4-11 (- 1.5m)	13095* (5940*)	13095* (5940*)	23523* (10670*)	23369* (10600)	19202* (8710*)	12522 (5680)	13228 (6000)	8488 (3850)				10273* (4660*)	7606 (3450)	21-5 (6562)
- 9-10 (- 3m)			23832* (10810*)	23744 (10770)	16865* (7650*)	12698 (5760)						12853* (5830*)	9612 (4360)	18-2 (5548)

LIFT CAPACITIES – ARM LENGTH: 8-10 (2.7M), 16-II (5.15M) MONOBOOM, TRACKSHOES: 28IN (700MM), NO BUCKET. JS190 LC MONO

Reach	4-11 (1.5m)		9-10 (3m)		14-9 (4.5m)		19-8 (6m)		24-7 (7.5m)		Capacity at Max Reach			
														
Load Point Ht.	lb (kg)	lb (kg)	lb (kg)	lb (kg)	lb (kg)	lb (kg)	lb (kg)	lb (kg)	lb (kg)	lb (kg)	lb (kg)	lb (kg)	ft-in (mm)	
24-7 (7.5m)												6415* (2910*)	6415* (2910*)	16-8 (5120)
19-8 (6m)							8620* (3910*)	8620* (3910*)				5710* (2590*)	5710* (2590*)	21-1 (6445)
14-9 (4.5m)					11001* (4990*)	11001* (4990*)	10207* (4630*)	9458 (4290)				5489* (2490*)	5489* (2490*)	23-7 (7227)
9-10 (3m)			21054* (9550*)	21054* (9550*)	14021* (6360*)	13779 (6250)	11508* (5220*)	9127 (4140)	7231* (3280*)	6592 (2990)		5578* (2530*)	5578* (2530*)	25-1 (7637)
4-11 (1.5m)			11420* (5180*)	11420* (5180*)	17152* (7780*)	13007 (5900)	12985* (5890*)	8774 (3980)	8995* (4080*)	6459 (2930)		5908* (2680*)	5908* (2680*)	25-4 (7735)
0 (0m)			14242* (6460*)	14242* (6460*)	19048* (8640*)	12522 (5680)	13250 (6010)	8510 (3860)	7209* (3270*)	6349 (2880)		6570* (2980*)	6305 (2860)	24-7 (7534)
- 4-11 (- 1.5m)	12809* (5810*)	12809* (5810*)	22333* (10130*)	22333* (10130*)	19312* (8760*)	12368 (5610)	13139 (5960)	8400 (3810)				7870* (3570*)	6922 (3140)	23-0 (7008)
- 9-10 (- 3m)	21693* (9840*)	21693* (9840*)	25507* (11570*)	23303 (10570)	17747* (8050*)	12478 (5660)	12610* (5720*)	8532 (3870)				10780* (4890*)	8422 (3820)	19-9 (6070)
- 14-9 (- 4.5m)			18717* (8490*)	18717* (8490*)								12368* (5610*)	12368* (5610*)	14-6 (4463)





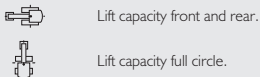







LIFT CAPACITIES – ARM LENGTH: 10-0 (3.05M), 16-II (5.15M) MONOBOOM, TRACKSHOES: 28IN (700MM), NO BUCKET. JS190 LC MONO

Reach	4-11 (1.5m)		9-10 (3m)		14-9 (4.5m)		19-8 (6m)		24-7 (7.5m)		Capacity at Max Reach			
														
Load Point Ht.	lb (kg)	lb (kg)	lb (kg)	lb (kg)	lb (kg)	lb (kg)	lb (kg)	lb (kg)	lb (kg)	lb (kg)	lb (kg)	lb (kg)	ft-in (mm)	
24-7 (7.5m)												5357* (2430*)	5357* (2430*)	18-3 (5581)
19-8 (6m)							8311* (3770*)	8311* (3770*)				4806* (2180*)	4806* (2180*)	22-4 (6816)
14-9 (4.5m)							9502* (4310*)	9458 (4290)	5203* (2360*)	5203* (2360*)		4652* (2110*)	4652* (2110*)	24-8 (7559)
9-10 (3m)			18805* (8530*)	18805* (8530*)	13051* (5920*)	13051* (5920*)	10869* (4930*)	9105 (4130)	8201* (3720*)	6548 (2970)		4718* (2140*)	4718* (2140*)	26-1 (7951)
4-11 (1.5m)			15498* (7030*)	15498* (7030*)	16402* (7440*)	13073* (5930)	12500* (5670*)	8730 (3960)	8722 (4410)	6371 (2890)		5004* (2270*)	5004* (2270*)	26-4 (8045)
0 (0m)			15035* (6820*)	15035* (6820*)	18651* (8460*)	12522* (5680)	13206 (5990)	8444 (3830)	9590 (4350)	6239 (2830)		5556* (2520*)	5556* (2520*)	25-8 (7853)
- 4-11 (- 1.5m)	11883* (5390*)	11883* (5390*)	21164* (9600*)	21164* (9600*)	19290* (8750*)	12302 (5580)	13029 (5910)	8311 (3770)				6592* (2990*)	6371 (2890)	24-1 (7350)
- 9-10 (- 3m)	19334* (8770*)	19334* (8770*)	26610* (12070*)	23148 (10500)	18210* (8260*)	12346 (5600)	13095 (5940)	8355 (3790)				8774* (3980*)	7628 (3460)	21-2 (6463)
- 14-9 (- 4.5m)			20856* (9460*)	20856* (9460*)	14154* (6420*)	12721 (5770)						12147* (5510*)	11089 (5030)	16-4 (4987)















Notes: 1. The above loads are in compliance with SAE and ISO Hydraulic Excavator Lift Capacity Standards.
 2. They do not exceed 87% of hydraulic lifting capacity or 75% of tipping load.
 3. Rated loads marked with an asterisk (*) are limited by hydraulic capacity rather than tipping load.











LIFT CAPACITIES – ARM LENGTH: 7-5 (2.25M), 16-II (5.15M) MONOBOOM, TRACKSHOES: 20IN (500MM), NO BUCKET. JSI90 NLC MONO

Reach	4-11 (1.5m)		9-10 (3m)		14-9 (4.5m)		19-8 (6m)		24-7 (7.5m)		Capacity at Max Reach			
														
Load Point Ht.	lb (kg)	lb (kg)	lb (kg)	lb (kg)	lb (kg)	lb (kg)	lb (kg)	lb (kg)	lb (kg)	lb (kg)	lb (kg)	lb (kg)	ft-in (mm)	
24-7 (7.5m)												8598* (3900*)	8598* (3900*)	14-7 (4484)
19-8 (6m)												7385* (3350*)	7385* (3350*)	19-5 (5956)
14-9 (4.5m)					12169* (5520*)	12169* (5520*)	11023* (5000*)	8355 (3790)				7055* (3200*)	6900 (3130)	22-3 (6795)
9-10 (3m)					15168* (6880*)	12125 (5500)	12191* (5530*)	8091 (3670)				7121* (3230*)	6173 (2800)	23-7 (7230)
4-11 (1.5m)					18056* (8190*)	11464 (5200)	13117 (5950)	7804 (3540)				7540* (3420*)	5930 (2690)	24-1 (7334)
0 (0m)			4960* (2250*)	11574* (5250*)	19467* (8830*)	11111 (5040)	12875 (5840)	7606 (3450)				8444* (3830*)	6085 (2760)	23-4 (7122)
- 4-11 (- 1.5m)	13095* (5940*)	13095* (5940*)	23523* (10670*)	20260 (9190)	19202* (8710*)	11045 (5010)	12831 (5820)	7562 (3430)				10273* (4660*)	6768 (3070)	21-5 (6562)
- 9-10 (- 3m)			23832* (10810*)	20591 (9340)	16865* (7650*)	11243 (5100)						12853* (5830*)	8554 (3880)	18-2 (5548)

LIFT CAPACITIES – ARM LENGTH: 8-10 (2.7M), 16-II (5.15M) MONOBOOM, TRACKSHOES: 20IN (500MM), NO BUCKET. JSI90 NLC MONO

Reach	4-11 (1.5m)		9-10 (3m)		14-9 (4.5m)		19-8 (6m)		24-7 (7.5m)		Capacity at Max Reach			
														
Load Point Ht.	lb (kg)	lb (kg)	lb (kg)	lb (kg)	lb (kg)	lb (kg)	lb (kg)	lb (kg)	lb (kg)	lb (kg)	lb (kg)	lb (kg)	ft-in (mm)	
24-7 (7.5m)												6415* (2910*)	6415* (2910*)	16-8 (5120)
19-8 (6m)							8620* (3910*)	8620* (3910*)				5710* (2590*)	5710* (2590*)	21-1 (6445)
14-9 (4.5m)					11001* (4990*)	11001* (4990*)	10207* (4630*)	8488 (3850)				5489* (2490*)	5489* (2490*)	23-7 (7227)
9-10 (3m)			21054* (9550*)	21054* (9550*)	14021* (6360*)	12721 (5770)	11508* (5220*)	8179 (3710)	7231* (3280*)	5886 (2670)		5578* (2530*)	5578* (2530*)	25-1 (7637)
4-11 (1.5m)			11420* (5180*)	11420* (5180*)	17152* (7780*)	11508 (5220)	12985* (5890*)	7826 (3550)	8995* (4080*)	5754 (2610)		5908* (2680*)	5512 (2500)	25-4 (7735)
0 (0m)			14242* (6460*)	14242* (6460*)	19048* (8640*)	11045 (5010)	12853 (5830)	7562 (3430)	7209* (3270*)	5644 (2560)		6570* (2980*)	5622 (2550)	24-7 (7534)
- 4-11 (- 1.5m)	12809* (5810*)	12809* (5810*)	22333* (10130*)	19863* (9010)	19312* (8760*)	10913 (4950)	12743 (5780)	8554 (3880)				7870* (3570*)	6151 (2790)	23-0 (7008)
- 9-10 (- 3m)	21693* (9840*)	21693* (9840*)	25507* (11570*)	42218* (19150)	17747* (8050*)	11023 (5000)	12610* (5720*)	7584 (3440)				10780* (4890*)	7496 (3400)	19-9 (6070)
- 14-9 (- 4.5m)			18717* (8490*)	18717* (8490*)								12368* (5610*)	11684 (5300)	14-6 (4463)

LIFT CAPACITIES – ARM LENGTH: 10-0 (3.05M), 16-II (5.15M) MONOBOOM, TRACKSHOES: 20IN (500MM), NO BUCKET. JSI90 NLC MONO



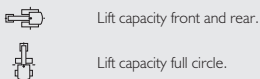







Reach	4-11 (1.5m)		9-10 (3m)		14-9 (4.5m)		19-8 (6m)		24-7 (7.5m)		Capacity at Max Reach			
														
Load Point Ht.	lb (kg)	lb (kg)	lb (kg)	lb (kg)	lb (kg)	lb (kg)	lb (kg)	lb (kg)	lb (kg)	lb (kg)	lb (kg)	lb (kg)	ft-in (mm)	
24-7 (7.5m)												5357* (2430*)	5357* (2430*)	18-3 (5581)
19-8 (6m)							8311* (3770*)	8311* (3770*)				4806* (2180*)	4806* (2180*)	22-4 (6816)
14-9 (4.5m)							9502* (4310*)	8488 (3850)	5203* (2360*)	5203* (2360*)		4652* (2110*)	4652* (2110*)	24-8 (7559)
9-10 (3m)			18805* (8530*)	18805* (8530*)	13051* (5920*)	12368 (5610)	10869* (4930*)	8157 (3700)	8201* (3720*)	5842 (2650)		4718* (2140*)	4718* (2140*)	26-1 (7951)
4-11 (1.5m)			15498* (7030*)	15498* (7030*)	16402* (7440*)	11574 (5250)	12500* (5670*)	7782 (3530)	9436 (4280)	5688 (2580)		5004* (2270*)	5004* (2270*)	26-4 (8045)
0 (0m)			15035* (6820*)	15035* (6820*)	18651* (8460*)	11045 (5010)	12809 (5810)	7496 (3400)	9281 (4210)	5556 (2520)		5556* (2520*)	5225* (2370*)	25-8 (7853)
- 4-11 (- 1.5m)	11883* (5390*)	11883* (5390*)	21164* (9600*)	19775* (8970*)	19290* (8750*)	10847 (4920)	12654 (5740)	7363 (3340)				6592* (2990*)	5666 (2570)	24-1 (7350)
- 9-10 (- 3m)	19334* (8770*)	19334* (8770*)	26610* (12070*)	20018 (9080)	18210* (8260*)	10891 (4940)	12698 (5760)	7407 (3360)				8774* (3980*)	6768 (3070)	21-2 (6463)
- 14-9 (- 4.5m)			20856* (9460*)	20613 (9350)	14154* (6420*)	11266 (5110)						12147* (5510*)	9833 (4460)	16-4 (4987)













Notes:

1. The above loads are in compliance with SAE and ISO Hydraulic Excavator Lift Capacity Standards.
2. They do not exceed 87% of hydraulic lifting capacity or 75% of tipping load.
3. Rated loads marked with an asterisk (*) are limited by hydraulic capacity rather than tipping load.











LIFT CAPACITIES – ARM LENGTH: 7-5 (2.25M), 17-7 (5.35M) T.A.B., TRACKSHOES: 28IN (700MM), NO BUCKET. JSI90 LC T.A.B.

Reach	9-10 (3m)		14-9 (4.5m)		19-8 (6m)		24-7 (7.5m)		Capacity at Max Reach		ft-in (mm)
											
Load Point Ht.	lb (kg)	lb (kg)	lb (kg)	lb (kg)	lb (kg)	lb (kg)	lb (kg)	lb (kg)	lb (kg)	lb (kg)	
29-6 (9m)									16204* (7350*)	16204* (7350*)	7-2 (2181)
24-7 (7.5m)	13117* (5950*)	13117* (5950*)	12768* (5790*)	12765* (5790*)					9237* (4190*)	9237* (4190*)	16-4 (4997)
19-8 (6m)	11111* (5040*)	11111* (5040*)	12875* (5840*)	12875* (5840*)	11486* (5210*)	9281 (4210)			7760* (3520*)	7760* (3520*)	20-8 (6349)
14-9 (4.5m)	18364* (8330*)	18364* (8330*)	15741* (7140*)	14109 (6400)	13360* (6060*)	9127 (4140)			7209* (3270*)	6922 (3140)	23-4 (7141)
9-10 (3m)			18408* (8350*)	13228 (6000)	13669 (6200)	8796 (3990)	8532* (3870*)	6237 (2870)	7055* (3200*)	6261 (2840)	24-8 (7556)
4-11 (1.5m)			19246* (8730*)	12478 (5660)	13272 (6020)	8444 (3830)	9612 (4360)	6217 (2820)	7253* (3290*)	6063 (2750)	25-1 (7655)
0 (0m)			18078* (8200*)	12147 (5510)	13051 (5920)	8245 (3740)			7782* (3530*)	6239 (2830)	24-4 (7452)
- 4-11 (- 1.5m)	16645* (7550*)	16645* (7550*)	15035* (6820*)	1215 (5500)	11221* (5090*)	8223 (3730)			7937* (3600*)	6922 (3140)	22-7 (6920)

LIFT CAPACITIES – ARM LENGTH: 8-10 (2.7M), 17-7 (5.35M) T.A.B., TRACKSHOES: 28IN (700MM), NO BUCKET. JSI90 LC T.A.B.

Reach	9-10 (3m)		14-9 (4.5m)		19-8 (6m)		24-7 (7.5m)		Capacity at Max Reach		ft-in (mm)
											
Load Point Ht.	lb (kg)	lb (kg)	lb (kg)	lb (kg)	lb (kg)	lb (kg)	lb (kg)	lb (kg)	lb (kg)	lb (kg)	
29-6 (9m)	12015* (5450*)	12015* (5450*)							9678* (4390*)	9678* (4390*)	11-2 (3428)
24-7 (7.5m)			10736* (4870*)	10736* (4870*)					6834* (3100*)	6834* (3100*)	18-5 (5640)
19-8 (6m)			10428* (4730*)	10428* (4730*)	10273* (4660*)	9502 (4310)			5952* (2700*)	5952* (2700*)	22-5 (6864)
14-9 (4.5m)	11376* (5160*)	11376* (5160*)	12213* (5540*)	12213* (5540*)	11861* (5380*)	9281 (4210)	7077* (3210*)	6504 (2950)	5600* (2540*)	5600* (2540*)	24-9 (7602)
9-10 (3m)			17747* (8050*)	13426 (6090)	13624* (6180*)	8885 (4030)	9833 (4460)	6393 (2900)	5534* (2510*)	5534* (2510*)	26-2 (7992)
4-11 (1.5m)			19048* (8640*)	12544 (5690)	13316 (6040)	8488 (3850)	9634 (4370)	6239 (2830)	5688* (2580*)	5600 (2540)	26-5 (8086)
0 (0m)			18519* (8400*)	12059 (5470)	13007 (5900)	8201 (3720)	9524 (4320)	6129 (2780)	6085* (2760*)	5732 (2600)	25-9 (7894)
- 4-11 (- 1.5m)	16512* (7490*)	16512* (7490*)	16094* (7300*)	11949 (5420)	12059* (5470*)	8113 (3680)			6900* (3130*)	6283 (2850)	24-3 (7394)
- 9-10 (- 3m)			11596* (5260*)	11596* (5260*)	8069* (3660*)	8069* (3660*)			7033* (3190*)	7033 (3190*)	20-6 (6289)

LIFT CAPACITIES – ARM LENGTH: 10-0 (3.05M), 17-7 (5.35M) T.A.B., TRACKSHOES: 28IN (700MM), NO BUCKET. JSI90 LC T.A.B.

Reach	9-10 (3m)		14-9 (4.5m)		19-8 (6m)		24-7 (7.5m)		Capacity at Max Reach		ft-in (mm)
											
Load Point Ht.	lb (kg)	lb (kg)	lb (kg)	lb (kg)	lb (kg)	lb (kg)	lb (kg)	lb (kg)	lb (kg)	lb (kg)	
29-6 (9m)	10193* (4950*)	10193* (4950*)							7540* (3420*)	7540* (3420*)	13-6 (4152)
24-7 (7.5m)			9325* (4230*)	9325* (4230*)	6614* (3000*)	6614* (3000*)			5666* (2570*)	5666* (2570*)	20-0 (6102)
19-8 (6m)			8840* (4010*)	8840* (4010*)	9149* (4150*)	9149* (4150*)			5004* (2270*)	5004* (2270*)	23-8 (7247)
14-9 (4.5m)	8554* (3880*)	8554* (3880*)	10053* (4560*)	10053* (4560*)	10273* (4660*)	9281 (4210)	8069* (3660*)	6504 (2950)	4718* (2140*)	4718* (2140*)	26-1 (7949)
9-10 (3m)			17130* (7770*)	13558 (6150)	13250* (6010*)	8885 (4030)	9788 (4440)	6371 (2890)	4674* (2120*)	4674* (2120*)	27-3 (8322)
4-11 (1.5m)			18783* (8520*)	12632 (5730)	13316 (6040)	8466 (3840)	9568 (4340)	6173 (2800)	4806* (2180*)	4806* (2180*)	27-6 (8413)
0 (0m)	9325* (4230*)	9325* (4230*)	18739 (8500)	12059 (5470)	12693 (5880)	8135 (3690)	9414 (4270)	6019 (2730)	5137* (2330*)	5137* (2330*)	27-0 (8229)
- 4-11 (- 1.5m)	15741* (7140*)	15741* (7140*)	16755* (7600*)	11861 (5380)	12478* (5660*)	8003 (3630)	8686* (3940*)	5997 (2720)	5820* (2640*)	5776 (2620)	25-4 (7750)
- 9-10 (- 3m)	15961* (7240*)	15961* (7240*)	12787* (5800*)	11993 (5440)	9237* (4190*)	8091 (3670)			6283* (2850*)	6283* (2850*)	22-5 (6867)



Lift capacity front and rear.











Notes:

1. The above loads are in compliance with SAE and ISO Hydraulic Excavator Lift Capacity Standards.
2. They do not exceed 87% of hydraulic lifting capacity or 75% of tipping load.
3. Rated loads marked with an asterisk (*) are limited by hydraulic capacity rather than tipping load.













Lift capacity full circle.











LIFT CAPACITIES – ARM LENGTH: 7-5 (2.25M), 17-7 (5.35M) T.A.B., TRACKSHOES: 20IN (500MM), NO BUCKET. JSI90 NLC T.A.B.

Reach	9-10 (3m)		14-9 (4.5m)		19-8 (6m)		24-7 (7.5m)		Capacity at Max Reach		ft-in (mm)
											
Load Point Ht.	lb (kg)	lb (kg)	lb (kg)	lb (kg)	lb (kg)	lb (kg)	lb (kg)	lb (kg)	lb (kg)	lb (kg)	
29-6 (9m)									16204* (7350*)	16204* (7350*)	7-2 (2181)
24-7 (7.5m)	13117* (5950*)	13117* (5950*)	12765* (5790*)	12765* (5790*)					9237* (4190*)	9237* (4190*)	16-4 (4997)
19-8 (6m)	11111* (5040*)	11111* (5040*)	12875* (5840*)	12875* (5840*)	11486* (5210*)	8311 (3770)			7760* (3520*)	7496 (3400)	20-8 (6349)
14-9 (4.5m)	18364* (8330*)	18364* (8330*)	15741* (7140*)	12566 (5700)	13360* (6060*)	8157 (3700)			7209* (3270*)	6173 (2800)	23-4 (7141)
9-10 (3m)			18408* (8350*)	11728 (5320)	13272 (6020)	7826 (3550)	8532* (3870*)	5622 (2550)	7055* (3200*)	5556 (2520)	24-8 (7556)
4-11 (1.5m)			19246* (8730*)	11001 (4990)	12875 (5840)	7496 (3400)	9325 (4230)	5534 (2510)	7253* (3290*)	5357 (2430)	25-1 (7655)
0 (0m)			18078* (8200*)	10670 (4840)	12654 (5740)	7275 (3300)			7782* (3530*)	5534 (2510)	24-4 (7452)
- 4-11 (- 1.5m)	16645* (7550*)	16645* (7550*)	15035* (6820*)	10648 (4830)	11221* (5090*)	7253 (3290)			7937* (3600*)	6129 (2780)	22-7 (6920)

LIFT CAPACITIES –ARM LENGTH: 8-10 (2.7M), 17-7 (5.35M) T.A.B., TRACKSHOES: 20IN (500MM), NO BUCKET. JSI90 NLC T.A.B.

Reach	9-10 (3m)		14-9 (4.5m)		19-8 (6m)		24-7 (7.5m)		Capacity at Max Reach		ft-in (mm)
											
Load Point Ht.	lb (kg)	lb (kg)	lb (kg)	lb (kg)	lb (kg)	lb (kg)	lb (kg)	lb (kg)	lb (kg)	lb (kg)	
29-6 (9m)	12015* (5450*)	12015* (5450*)							9678* (4390*)	9678* (4390*)	11-2 (3428)
24-7 (7.5m)			10736* (4870*)	10736* (4870*)					6834* (3100*)	6834* (3100*)	18-5 (5640)
19-8 (6m)			10428* (4730*)	10428* (4730*)	10273* (4660*)	8510 (3860)			5952* (2700*)	5952* (2700*)	22-5 (6864)
14-9 (4.5m)	11376* (5160*)	11376* (5160*)	12213* (5540*)	12213* (5540*)	11861* (5380*)	8311 (3770)	7077* (3210*)	5798 (2630)	5600* (2540*)	5600* (2540*)	24-9 (7602)
9-10 (3m)			17747* (8050*)	11927 (5410)	13382 (6070)	7915 (3590)	9524 (4320)	5688 (2580)	5534* (2510*)	5137 (2330)	26-2 (7992)
4-11 (1.5m)			19048* (8640*)	11045 (5010)	12919 (5860)	7518 (3410)	9348 (4240)	5534 (2510)	5688* (2580*)	4960 (2250)	26-5 (8086)
0 (0m)			18519* (8400*)	10582 (4800)	12610 (5720)	7231 (3280)	9215 (4180)	5423 (2460)	6085* (2760*)	5093 (2310)	25-9 (7894)
- 4-11 (- 1.5m)	16512* (7490*)	16512* (7490*)	16094* (7300*)	10472 (4750)	12059* (5470*)	7165 (3250)			6900* (3130*)	5556 (2520)	24-3 (7394)
- 9-10 (- 3m)			11596* (5260*)	10648 (4830)	8069* (3660*)	7319 (3320)			7033* (3190*)	6922 (3140)	20-6 (6289)

LIFT CAPACITIES – ARM LENGTH: 10-0 (3.05M), 17-7 (5.35M) T.A.B., TRACKSHOES: 20IN (500MM), NO BUCKET. JSI90 NLC T.A.B.

Reach	9-10 (3m)		14-9 (4.5m)		19-8 (6m)		24-7 (7.5m)		Capacity at Max Reach		ft-in (mm)
											
Load Point Ht.	lb (kg)	lb (kg)	lb (kg)	lb (kg)	lb (kg)	lb (kg)	lb (kg)	lb (kg)	lb (kg)	lb (kg)	
29-6 (9m)	10913* (4950*)	10913* (4950*)							7540* (3420*)	7540* (3420*)	13-6 (4152)
24-7 (7.5m)			9325* (4230*)	9325* (4230*)	6614* (3000*)	6614* (3000*)			5666* (2570*)	5666* (2570*)	20-0 (6102)
19-8 (6m)			8840* (4010*)	8840* (4010*)	9149* (4150*)	8532 (3870)			5004* (2270*)	5004* (2270*)	23-8 (7247)
14-9 (4.5m)	8554* (3880*)	8554* (3880*)	10053* (4560*)	10053* (4560*)	10273* (4660*)	8311 (3770)	8069* (3660*)	5798 (2630)	4718* (2140*)	4718* (2140*)	26-1 (7949)
9-10 (3m)			17130* (7770*)	12037 (5460)	13250* (6010*)	7915 (3590)	9480 (4300)	5644 (2560)	4674* (2120*)	4674* (2120*)	27-3 (8322)
4-11 (1.5m)			18733* (8520*)	11133 (5050)	12919 (5860)	7946 (3400)	9281 (4210)	5467 (2480)	4806* (2180*)	4608 (2090)	27-6 (8413)
0 (0m)	8325* (4230*)	8325* (4230*)	18739* (8500*)	10582 (4800)	12566 (5700)	7187 (3260)	8127 (4140)	5313 (2410)	5137* (2330*)	4696 (2130)	27-0 (8229)
- 4-11 (- 1.5m)	15741* (7140*)	15741* (7140*)	16755* (7600*)	10384 (4710)	12412 (5630)	7055 (3200)	8686* (3940*)	5291 (2400)	5820* (2640*)	5115 (2320)	25-4 (7750)
- 9-10 (- 3m)	15961* (7240*)	15961* (7240*)	12787* (5800*)	10516 (4770)	9237* (4190*)	7143 (3240)			6283* (2850*)	6085 (2760)	22-5 (6867)



Lift capacity front and rear.

Notes:

1. The above loads are in compliance with SAE and ISO Hydraulic Excavator Lift Capacity Standards.
2. They do not exceed 87% of hydraulic lifting capacity or 75% of tipping load.
3. Rated loads marked with an asterisk (*) are limited by hydraulic capacity rather than tipping load.



Lift capacity full circle.



ONE COMPANY, OVER 300 MACHINES.

Tracked Excavator JSI60/190 NLC/LC

Engine power: 125 hp (93 kW) Bucket capacity: 16.2 - 30.0 ft³
 Operating weight: 37997 - 46793 lb

JCB North American – Headquarters

Savannah. 2000 Bamford Blvd., Savannah, Georgia, 31322 Tel: (912) 447-2000
 Download the very latest information on this product range at www.jcb.com

JCB inc. All rights reserved. No part of this publication may be reproduced, stored in a retrieval system, or transmitted in any form or by any other means, electronic, mechanical, photocopying or otherwise, without prior permission from JCB inc. All references in this publication to operating weights, sizes, capacities and other performance measurements are provided for guidance only and may vary dependant upon the exact specification of machine. They should not therefore be relied upon in relation to suitability for a particular application. Guidance and advice should always be sought from your JCB Dealer. JCB reserves the right to change specifications without notice. Illustrations and specifications shown may include optional equipment and accessories. The JCB logo is a registered trademark of J C Bamford Excavators Ltd.

Your nearest JCB Dealer

