



# 2815R2 /2810R2 12815R2 / 12810R2

## FLEX-WING ROTARY CUTTER/SHREDDER

Published 04/13

Part No. 50071222

# OPERATOR'S MANUAL



This Operator's Manual is an integral part of the safe operation of this machine and must be maintained with the unit at all times. **READ, UNDERSTAND, and FOLLOW** the Safety and Operation Instructions contained in this manual before operating the equipment. *C01-Cover\_B*

Safety Video

Important Operating and Safety Instructions are found in the Mower Safety Video that can be instantly accessed on the internet at: [www.algqr.com/bve](http://www.algqr.com/bve)



[www.algqr.com/bve](http://www.algqr.com/bve)

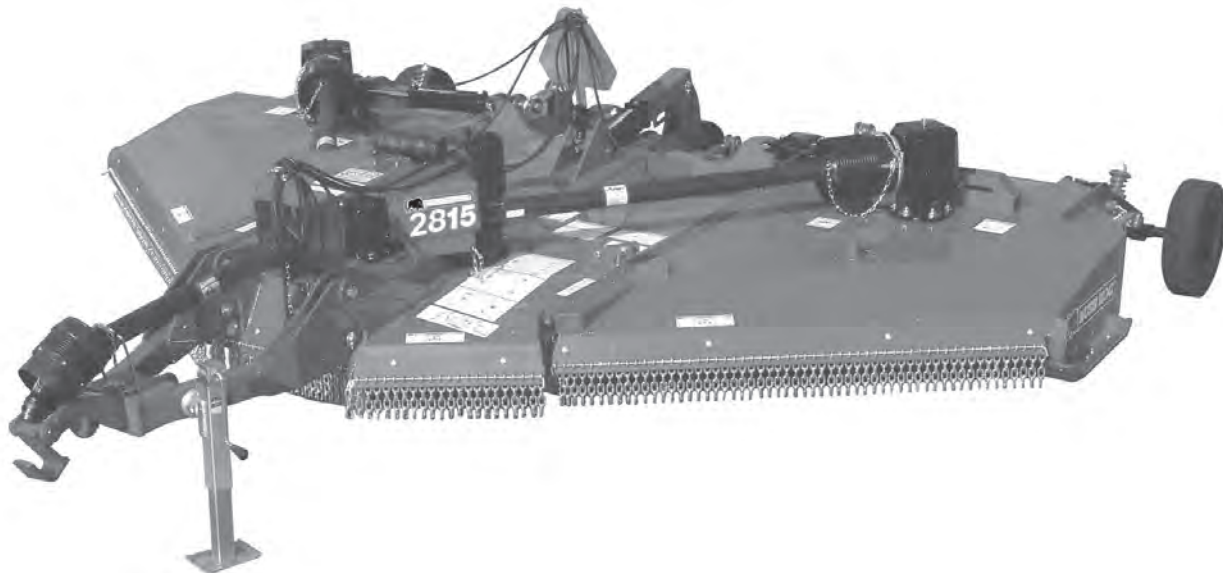

**BUSH HOG®**

2501 Griffin Ave.  
Selma, AL 36703  
334-874-2700  
[www.bushhog.com](http://www.bushhog.com)

Bush Hog Web Page



[www.algqr.com/bwe](http://www.algqr.com/bwe)



©2012 Alamo Group Inc.

\$0.00

<b>! PELIGRO</b>	<b>! DANGER</b>
Si no puede leer inglés: antes de poner en funcionamiento este equipo, solicite que alguien le traduzca los mensajes de seguridad o vaya al sitio web para consultar los mensajes de seguridad y las etiquetas ya traducidos.	Si vous ne savez pas lire le français: avant d'utiliser l'équipement, demandez à une personne de vous traduire les messages de sécurité ou allez sur le site Internet pour voir la traduction des autocollants et des messages de sécurité.
<b>El Manual del Operador Seguridad vídeo</b>   	<b>Manuel de l'Opérateur</b>  
<a href="http://www.algqr.com/bms">www.algqr.com/bms</a> <a href="http://www.algqr.com/bvs">www.algqr.com/bvs</a>	D813_1 <a href="http://www.algqr.com/bmf">www.algqr.com/bmf</a>

<b>! PERIGO</b>	<b>! GEFAHR</b>
Caso você não leia inglês: antes de operar o equipamento, peça para alguém traduzir as mensagens de segurança ou visite a web e obtenha tais mensagens ou os decalques traduzidos.	Falls Sie Deutsch nicht lesen können: Lassen Sie sich, bevor Sie das Gerät in Betrieb nehmen, die Sicherheitshinweise von einer geeigneten Person in Ihre Sprache übersetzen. Oder suchen Sie auf unserer Website nach Übersetzungen von Schilderaufschriften und Sicherheitshinweisen.
<b>Manual do Operador</b>  	<b>Benutzerhandbuch</b>  
<a href="http://www.algqr.com/bmp">www.algqr.com/bmp</a>	D813_2 <a href="http://www.algqr.com/bmg">www.algqr.com/bmg</a>

Safety Video	Operator's & Parts Manuals	General Safety
		
<a href="http://www.algqr.com/bve">www.algqr.com/bve</a>	<a href="http://www.algqr.com/bpm">www.algqr.com/bpm</a>	<a href="http://www.algqr.com/bme">www.algqr.com/bme</a>

Safety Video



➤ **BE SAFE!**

➤ **BE ALERT!**

➤ **BE ALIVE!** [www.algqr.com/bve](http://www.algqr.com/bve)

➤ **BE TRAINED  
before operating  
the Mower!**

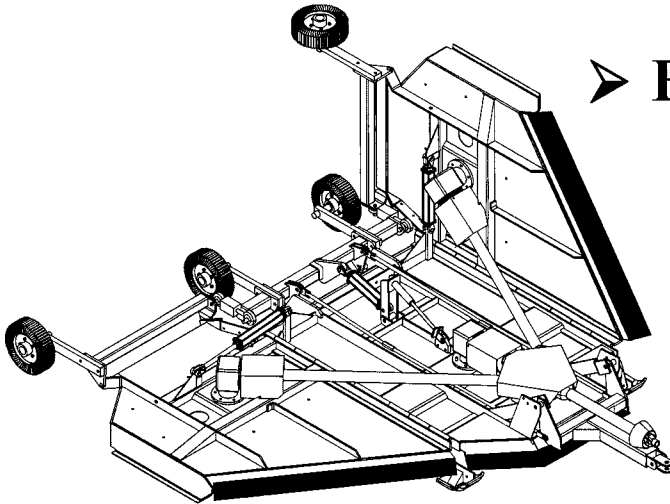

## *Safety Training Makes the Difference*

In order to reduce accidents and enhance the safe operation of mowers, *Bush Hog*, in cooperation with other industry manufacturers has developed the AEM/FEMA Industrial and Agricultural Mower Safety Practices video and guide book.

The video will familiarize and instruct mower-tractor operators in safe practices when using industrial and agricultural mowing equipment. It is important that Every Mower Operator be educated in the operation of their mowing equipment and be able to recognize the potential hazards that can occur while operating a mower. This video, along with the mower operator's manual and the warning messages on the mower, will significantly assist in this important education.

Your Authorized *Bush Hog* Dealer may have shown this video and presented you a DVD Video when you purchased your mower. If you or any mower operator have not seen this video, **Watch the Video, Read this Operator's Manual, and Complete the Video Guidebook** before operating your new mower. If you do not understand any of the instructions included in the video or operator's manual or if you have any questions concerning safety of operation, contact your supervisor, dealer or *Bush Hog*.

If you would like a VHS video tape of the video, please mail [AEMVideo@alamo-group.com](mailto:AEMVideo@alamo-group.com) or Fax AEM VHS Video at (830) 372-9529 or mail in a completed copy of the form on the back of this page to AEM VHS Video 1502 E Walnut Street, Seguin, TX 78155. and request the VHS video version. Please include your name, mailing address, mower model and serial number.

Every operator should be trained for each piece of equipment (Tractor and Mower), understand the intended use, and the potential hazards before operating the equipment.

The information and material listed above along with this Operator's Manual can assist you in meeting the OSHA requirement for annual operator training.

### **OSHA TRAINING REQUIREMENTS**

**The following training requirements have been taken from *Title 29, Code of Federal Regulations Part 1928.57 (a) (6)*. [www.osha.gov](http://www.osha.gov)**

Operator instructions. At the time of initial assignment and at least annually thereafter the employer shall instruct every employee who operates an agricultural tractor and implements in the safe operating practices and servicing of equipment with which they are or will be involved, and of any other practices dictated by the work environment.

**Bush Hog will provide  
one (1) AEM Mower Safety Practices Video**

- Please Send Me:  VHS Format – AEM/FEMA Mower Operator Safety Video  
 DVD Format – AEM/FEMA Mower Operator Safety Video  
 Mower Operator’s Manual  
 AEM Mower Operator’s Safety Manual

Requester Name \_\_\_\_\_ Phone: \_\_\_\_\_

Requester Address: \_\_\_\_\_

City \_\_\_\_\_

State \_\_\_\_\_

Zip Code \_\_\_\_\_

Mower Model: \_\_\_\_\_ Serial Number: \_\_\_\_\_

Date Purchased: \_\_\_\_\_ Dealer Salesperson: \_\_\_\_\_

Dealership Name: \_\_\_\_\_ Dealership Location: \_\_\_\_\_

Mail to:

AEM Video Services  
1502 E. Walnut Street  
Seguin, TX 78155

Or Fax to:

(830) 372-9529

Or Email to:

AEMVideo@alamo-group.com

# To the Owner/Operator/Dealer

This Operator's Manual is an integral part of the safe operation of this machine and must be maintained with the implement at all times. A Manual canister is provided on the implement where this manual can be properly stored. If you lose or damage this manual a free replacement manual can be obtained from an authorized Bush Hog dealer or by downloading the manual from the Bush Hog website [www.bushhog.com](http://www.bushhog.com)

**BEFORE YOU START!! READ, UNDERSTAND, and FOLLOW** the information provided in this manual, the AEM Mower Safety manual and the tractor operator's manual carefully to learn how to operate and service your machine properly. Failure to do so could result in personal injury to you and bystanders. All implements with moving parts are potentially hazardous. Every effort has been made to ensure that the machine is safe but operators must avoid engaging in unsafe practices and follow the written instructions provided. The manufacturer has designed this implement to be used with all its safety equipment properly attached to minimize the chance of accidents.

**SAFETY FIRST.** Completely read and understand the safety section of this manual before operating this equipment. Do not allow anyone to operate this equipment who has not fully read and understood this manual. Contact your Dealer to explain any instructions that you do not fully understand.

The care you give your Bush Hog Implement will greatly determine your satisfaction with its performance and its service life. Carefully read and follow the instructions in this manual to provide you with a thorough understanding of your new implement and its intended use and service requirements.

All references made in this manual to right, left, front, rear, top or bottom are as viewed facing the direction of forward travel with the implement properly attached to the tractor.

Replacement Parts information is located in a separate Parts Manual. Bush Hog mowers use balanced and matched system components for blade carriers, blades, cuttershafts, knives, knife hangers, rollers, drivetrain components, and bearings. These parts are made and tested to Bush Hog specifications. Non-genuine "will fit" parts do not consistently meet these specifications. The use of "will fit" parts may reduce mower performance, void warranties, and present a safety hazard. Use genuine Bush Hog mower parts for economy and safety.

For future reference, record your Bush Hog product model number and serial number.

Dealer		Telephone		Model Number	
Owner		Purchase Date:		Serial Number	

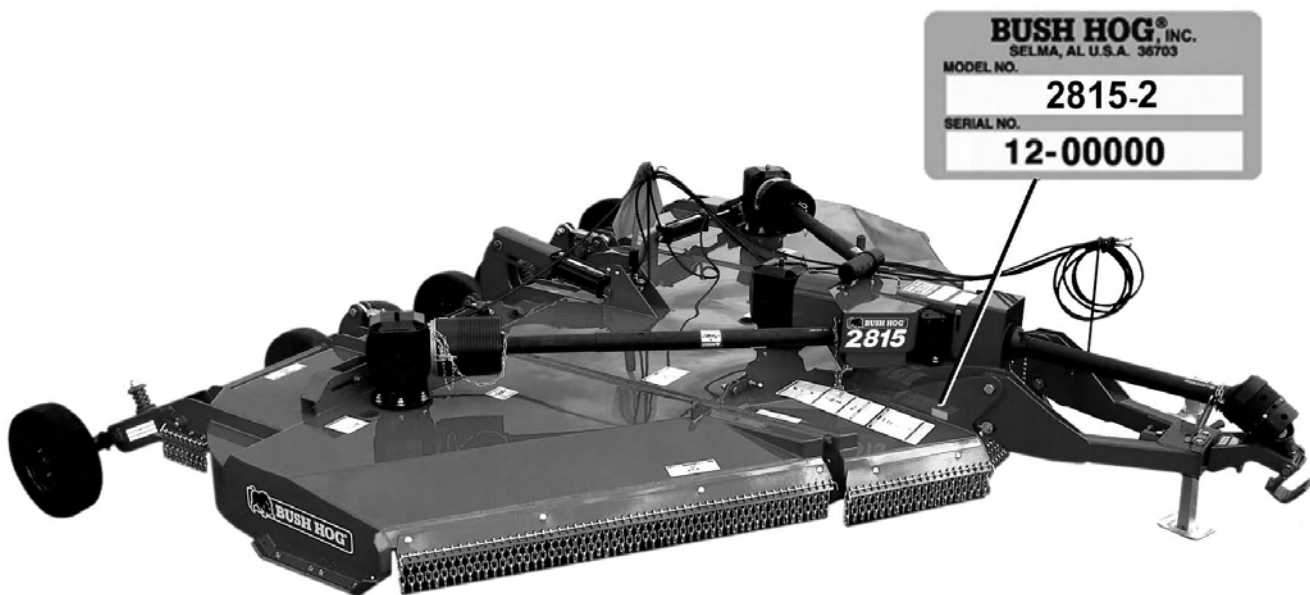

# DEALER to CUSTOMER Pre-Delivery/ Operation Instructions

Dealer should inform the Purchaser of this product of Warranty terms, provisions, and procedures that are applicable. Dealer should inform Purchaser to review the contents of the Operator's Manual including safety equipment, safe operation, and maintenance, to review the Safety Signs on the implement (and tractor if possible), and of Purchaser's responsibility to train his/her operators in safe operation procedures.

**IMPLEMENTS:** I have explained that Deflectors, Chain Guards, or Solid Skirts must be installed and maintained in good repair.

- **DRIVELINES:** I have made certain that all driveline, gearbox, and other shields are in good repair and fastened securely in place to prevent injuries from entanglement or thrown objects.
- **HYDRAULIC MACHINES:** I have explained the necessity of using clean hydraulic oil, changing filters as instructed, stopping leaks, damage caused by operating with over-heated oil, caring for hoses, using hoses of proper rating, maintaining the specified operating pressure and the potential hazard of oil's penetrating the skin.
- **FOLDING-TYPE IMPLEMENTS:** I have explained that it is not possible to guard against thrown objects when the head is lifted off ground and that operator is responsible to watch out for persons in the area. I have explained that the lifted mower head or boom can contact overhead obstructions with damage to cables and telephone lines and possible injury. I have explained that the extended head or boom or retracted boom can contact power lines with resulting electrocution, injury or death and that operator is responsible for keeping clear of such hazards.

## PRE-DELIVERY SERVICE CHECK AND ADJUST OR LUBRICATE AS REQUIRED

See Operator's Manual for Details

### Inspection Performed - Warranty and Safety Procedures Explained - Installation Complete

#### LUBRICATION & HYDRAULICS

- Gearbox (Oil Levels)
- Hydraulic Oil Level (External Tank)
- Tractor Hydraulic Oil Level
- Hydraulic Hoses (Not Kinked Tighten Connections)
- Front Pump Drive (Assembly Is Tight And Shaft Properly Aligned)

#### MOWER

- Spindle And Motor Bolts Properly Torqued
- Spindle Oil Level
- Blade Carrier Bolts Properly Torqued/Retaining Pin In Place
- Mower Cutting Height And Level Adjusted
- Cutting Shaft Bearings Lubricated
- All Hardware Properly Torqued
- Tire and Air Pressure/Lug Nuts (Correct Torque)
- Wheel Bearings (Check, Grease, and Preload)

#### ATTACHMENTS & INSTALLATION

- Deflectors Front And Rear
- Shredding Attachments
- Correct Blade Rotation Direction
- Axle Arms And Beams
- Tongue And Control Rods (Installed And Adjusted)
- All Bolts - Pins And Nuts (Proper Torque)

#### MOWER TO TRACTOR CONNECTIONS

- Draw Bar Length (Check And Set)
- A-Frame Pivot & Links
- Control Rods (Adjusted Equal)
- Axle Height (Adjusted)
- Cutting Height (Adjust)
- Mount Kit-Pre-Operation Check Complete
- Mower Wing (Adjust Level With The Center)
- Mower Wing (Check For Proper Raising Operation)
- C.V. Driveline (Check Max Turn Radius)
- Pull Type Hitch (Height Adjustment)
- Mounting Hardware Properly Torqued

#### SAFETY ITEMS

- Protective Shields (Operation And Installation)
- Driveline Clutch (Torque Limiter) (Adjust And Run In)
- Safety Decals (Installed)
- Operator's Manual (Supplied)
- Tractor PTO Shield (Installed)
- S.M.V. Emblem (Installed If Needed)
- Tongue Jack (Installation and Operation)
- Safety Tow Chain (Installed)
- ADMA Driveline Safety Manual Supplied
- AEM Mower Safety Manual (Supplied in Canister)
- AEM Mower Safety Video has been shown to Purchaser

# TABLE OF CONTENTS

<b>SAFETY SECTION</b> .....	<b>1-1</b>
GENERAL SAFETY INSTRUCTIONS AND PRACTICES.....	1-2
OPERATOR SAFETY.....	1-3
CRUSHING HAZARDS.....	1-4
CONNECTING OR DISCONNECTING IMPLEMENT SAFETY.....	1-5
THROWN OBJECTS HAZARDS.....	1-6
THROWN OBJECTS HAZARD (CONTINUED).....	1-7
RUN OVER HAZARDS.....	1-8
PTO ENTANGLEMENT HAZARDS.....	1-9
MOWER BLADE CONTACT HAZARDS.....	1-10
HIGH PRESSURE OIL LEAK HAZARD.....	1-10
ELECTRICAL & FIRE HAZARD.....	1-11
TRANSPORTING HAZARDS.....	1-12
HAZARDS WITH MAINTENANCE OF IMPLEMENT.....	1-13
PARTS INFORMATION.....	1-14
Decal Location.....	1-15
Decal Description.....	1-17
Federal Laws and Regulations.....	1-26
<b>INTRODUCTION SECTION</b> .....	<b>2-1</b>
Equipment Specifications.....	2-3
KEY OPERATION POINTS.....	2-4
<b>ASSEMBLY SECTION</b> .....	<b>3-1</b>
DEALER SET-UP INSTRUCTIONS.....	3-2
ASSEMBLY.....	3-2
Tongue.....	3-3
Hose Holder.....	3-3
LINKAGE RODS.....	3-3
TIRES AND WHEELS.....	3-4
HYDRAULICS.....	3-7
OPTIONAL VALVE MOUNTING BRACKET INSTALLATION.....	3-7
DRIVELINE ATTACHMENT TO IMPLEMENT.....	3-9
CV DRIVELINE.....	3-9
CENTER DRIVELINE.....	3-9
WING DRIVELINE.....	3-10
DRIVELINE ATTACHMENT.....	3-10
<b>OPERATION SECTION</b> .....	<b>4-1</b>
OPERATOR REQUIREMENTS.....	4-3
TRACTOR REQUIREMENTS.....	4-4
ROPS and Seat Belt.....	4-4
Tractor Safety Devices.....	4-4
Tractor Horsepower.....	4-5
Drawbar.....	4-5
Tractor Hydraulics.....	4-5
Front End Weight.....	4-5
Power Take Off (PTO).....	4-6
Tire Spacing.....	4-6
GETTING ON AND OFF THE TRACTOR.....	4-7
Boarding the Tractor.....	4-7
Dismounting the Tractor.....	4-7
STARTING THE TRACTOR.....	4-8

CONNECTING THE MOWER TO THE TRACTOR .....	4-9
Connecting Mower Tongue to the Tractor .....	4-9
Connecting Mower Hydraulic Lines to the Tractor .....	4-10
SETTING THE MOWER .....	4-12
Setting Deck Height .....	4-12
Setting Deck Pitch.....	4-13
DRIVELINE ATTACHMENT .....	4-14
Driveline Length Check .....	4-14
Constant Velocity (CV) Driveline.....	4-16
PRE-OPERATION INSPECTION AND SERVICE .....	4-17
Tractor Pre-Operation Inspection/Service.....	4-18
Mower Pre-Operation Inspection/Service .....	4-18
Cutting Component Inspection.....	4-22
Blade Bolt Inspection .....	4-24
DRIVING THE TRACTOR AND IMPLEMENT .....	4-27
Starting the Tractor .....	4-28
Brake and Differential Lock Setting.....	4-28
Operating the Mower Wings .....	4-28
Transport Position .....	4-29
Operating Position .....	4-29
Driving the Tractor and Cutter.....	4-30
Crossing Ditches and Steep Inclines .....	4-31
OPERATING THE TRACTOR AND IMPLEMENT .....	4-32
Foreign Debris Hazards .....	4-33
Bystanders/Passersby Precautions .....	4-33
Engaging the Power Take Off (PTO).....	4-34
PTO RPM and Ground Speed .....	4-35
Operating the Mower .....	4-35
Right of Way (Highway) Mowing.....	4-39
Shutting Down the Implement.....	4-40
DISCONNECTING THE MOWER FROM THE TRACTOR .....	4-40
MOWER STORAGE .....	4-42
TRANSPORTING THE TRACTOR AND IMPLEMENT .....	4-42
Tire and Wheels .....	4-44
Transporting on Public Roadways .....	4-44
TROUBLE SHOOTING GUIDE .....	4-48
<b>MAINTENANCE SECTION .....</b>	<b>5-1</b>
HAZARDS WITH MAINTENANCE OF IMPLEMENT.....	5-2
PARTS INFORMATION .....	5-3
Lubrication .....	5-3
CENTER & WING GEARBOXES .....	5-5
DIVIDER GEARBOX.....	5-5
MAIN CV DRIVELINE SAFETY SHIELD .....	5-6
SLIP CLUTCH ADJUSTMENT.....	5-8
BLADE REMOVAL.....	5-10
Blade Bolt Inspection .....	5-11
BLADE HOLDER ASSEMBLY .....	5-11
Blade Removal.....	5-11
Installation.....	5-12
WHEEL HUB ASSEMBLY .....	5-12
AXLE ARM SPRING .....	5-12
TONGUE.....	5-13
HIGH PRESSURE OIL LEAK HAZARD.....	5-14
HYDRAULIC HOSES.....	5-14
Flex Wing Hydraulic Cylinder Replacement Instructions .....	5-15
STORAGE .....	5-16



# **SAFETY SECTION**

Safety Section 1-1

# SAFETY

## **GENERAL SAFETY INSTRUCTIONS AND PRACTICES**

A careful operator is the best operator. Safety is of primary importance to the manufacturer and should be to the owner/operator. Most accidents can be avoided by being aware of your equipment, your surroundings, and observing certain precautions. The first section of this manual includes a list of Safety Messages that, if followed, will help protect the operator and bystanders from injury or death. Read and understand these Safety Messages before assembling, operating or servicing this Implement. This equipment should only be operated by those persons who have read the manual, who are responsible and trained, and who know how to do so responsibly.



The Safety Alert Symbol combined with a Signal Word, as seen below, is used throughout this manual and on decals which are attached to the equipment. The Safety Alert Symbol means: "ATTENTION! BECOME ALERT! YOUR SAFETY IS INVOLVED!" The Symbol and Signal Word are intended to warn the owner/operator of impending hazards and the degree of possible injury faced when operating this equipment.

**Practice all usual and customary safe working precautions and above all--- remember safety is up to YOU. Only YOU can prevent serious injury or death from unsafe practices.**



Indicates an imminently hazardous situation that, if not avoided, WILL result in DEATH OR VERY SERIOUS INJURY.



Indicates an imminently hazardous situation that, if not avoided, COULD result in DEATH OR SERIOUS INJURY.



Indicates an imminently hazardous situation that, if not avoided, MAY result in MINOR INJURY.



Identifies special instructions or procedures that, if not strictly observed, could result in damage to, or destruction of the machine, attachments or the environment.

**NOTE:** *Identifies points of particular interest for more efficient and convenient operation or repair.*

READ, UNDERSTAND, and FOLLOW the following Safety Messages. Serious injury or death may occur unless care is taken to follow the warnings and instructions stated in this Manual and in the Safety Messages on the implement. Always follow the instruction in this manual and use good common sense to avoid hazards.



**NOTE:** *If you want a translation of this safety section in one of the following Languages, please contact: Translations at 1502 E. Walnut Street Seguin, TX 78155; Fax: (830) 372-9529; Safety Section Translations are available in Spanish, Portuguese, French, German, Russian. PN GS01*

# SAFETY

## OPERATOR SAFETY

				
Read and understand Operator's Manual	Always wear Safety Glasses	Wear Hard Hat Safety Shoes	Never use Drugs or Alcohol when operating equipment	Wear Safety Vest when operating on or near roads



**TO AVOID SERIOUS INJURY OR DEATH DO THE FOLLOWING:**

- **READ, UNDERSTAND** and **FOLLOW** Operator's Manual instructions, Warnings and Safety Messages.
- **WEAR SAFETY GLASSES**, safety shoes, hard hat, hearing protection and gloves when operating or repairing equipment
- **WEAR** appropriate breathing respirator when operating in dusty conditions to avoid respiratory diseases.
- **DO NOT WEAR** loose clothing or jewelry to avoid rotating parts entanglement injury.
- **DO NOT USE DRUGS** or **ALCOHOL** before or while operating equipment.
- **DO NOT ALLOW** anyone to operate equipment under the influence of drug or alcohol.
- **CONSULT** medical professional for medication impairment side effects.
- **STAY ALERT**, prolonged operation can cause fatigue, **STOP** and **REST**.

## GENERAL OPERATING SAFETY

### **VISIBILITY CONDITIONS WHEN MOWING:**

- **OPERATE IN DAYLIGHT** or with lights that gives at least 100 yards clear visibility.
- **BE ABLE TO SEE** and identify passersby, steep slopes, ditches, drop-offs, overhead obstructions, power lines, debris and foreign objects.

### **GROUND SPEED WHEN MOWING:**

- **NORMAL SPEED** range is between 2 to 5mph.
- **ADJUST MOWING SPEED** for terrain conditions and grass type, density and cut height.
- **REDUCE MOWING SPEED** when near steep slopes, ditches, drop-offs, overhead obstructions, power lines and to avoid debris and foreign objects.

### **INSECT INFESTATION**

- Do Not operate in areas where bees or insects may attack unless you **WEAR PROTECTIVE CLOTHING** or use enclosed tractor cab.

### **PTO SPEED:**

- **DO NOT EXCEED IMPLEMENT RATED PTO SPEED**
- **AVOID** exceeding rated PTO speeds that may result in broken drivelines or blade failures.

### **SAFETY SIGNS:**

- **REPLACE** missing, damaged or unreadable safety signs immediately. *PN OS01*

**SAFETY**

# SAFETY

## CRUSHING HAZARDS

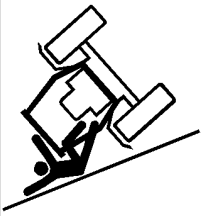
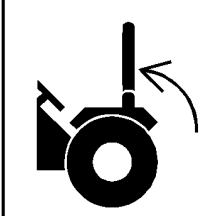
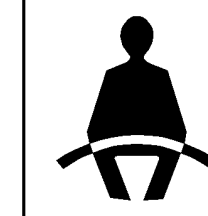
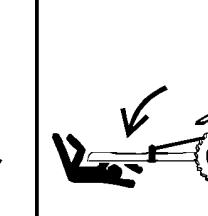
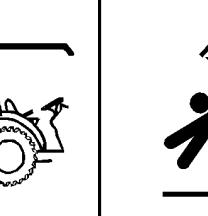
				
Crushing injury from roll over	Lock ROPS in up position	Always wear seatbelt	Crushing injury implement falling	Crushing injury wing falling



**TO AVOID SERIOUS INJURY OR DEATH FROM FALLING OFF TRACTOR, EQUIPMENT RUN OVER, ROLLOVER AND CRUSHING BY FALLING WING OR IMPLEMENT:**

- **USE ROPS** and **SEAT BELT** equipped tractors for mowing operations.
- **KEEP ROPS** lock in up position.
- **ALWAYS BUCKLE UP** seat belt when operating tractor and equipment.
- **ONLY OPERATE** tractor and equipment while seated in tractor seat.

### WHEN RAISING OR LOWERING WINGS:

- Raise or lower **ONLY WHILE SEATED** in tractor seat with seat belt buckled.
- Raise or lower **ONLY** when implement tongue is securely attached to tractor drawbar **TO AVOID** implement tip over.
- **KEEP BYSTANDERS CLEAR** of area **TO AVOID** crushing.
- **KEEP** sufficient clearance around implement and wings **TO AVOID** contacting buildings or overhead power lines.

**LIFTED Equipment can fall from mechanical or hydraulic failure or inadvertent Control Lever movement.**



**TO AVOID EQUIPMENT FALLING while working near or under lifted wings, components and implements raised by 3-Pointed tractor hitch:**

- **SECURELY SUPPORT** or **block up** raised equipment, wings and components.
- **BLOCK UP** and **securely support** equipment before putting hands, feet or body under raised equipment or lifted components.
- **KEEP BYSTANDERS CLEAR** of folded wings until wings are blocked or locked up.

### WHEN PARKING Implement and Tractor:

- **LOWER** implement, **LOCK** or **BLOCK** lifted parts before leaving equipment.
- **NEVER** leave implement unattended in a raised position.



**TO AVOID CHILDREN FALLING OFF OR BEING CRUSHED BY EQUIPMENT:**

- **NEVER ALLOW** children to play on or around Tractor or Implement.

### WHEN UNHITCHING IMPLEMENT:



- **LOWER** implement, **LOCK** or **BLOCK** lifted parts before leaving equipment.
- **USE** tongue jack to control implement tongue movement.
- **USE** tongue **JACK** to lift heavy implement tongues.
- **AVOID** overloading jack to prevent jack failure and injury. *(Refer to Instructions in Operation Section)*

### BEFORE REMOVING Wing Retaining Lock:

- **ATTACH** hoses to tractor.
- **FILL** Wing Cylinders with oil. *(Refer to Instructions in Operation Section)*
- **KEEP** bystanders away before operating wings.
- **LOWER WINGS** slowly and carefully. **PN CH01**

# SAFETY

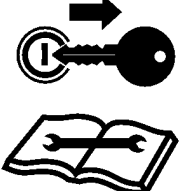
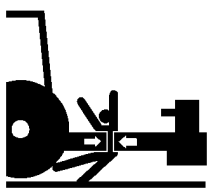
## CONNECTING OR DISCONNECTING IMPLEMENT SAFETY

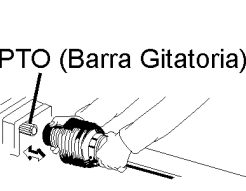
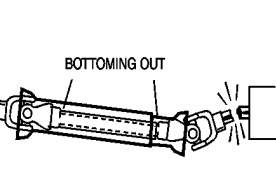
				
Stop Tractor Remove Key Read Manual	Crushing injury between tractor and implement	Crushing injury wing falling	Make sure PTO shaft is securely attached to tractor	Make sure PTO shaft are proper length



**TO AVOID SERIOUS INJURY OR DEATH FROM BEING CRUSHED BY TRACTOR OR IMPLEMENT:**

### WHEN BACKING tractor to implement hitch:

- **DO NOT ALLOW BYSTANDERS** between tractor and implement.

### BEFORE connecting and disconnecting implement hitch:

- **STOP TRACTOR ENGINE**, place transmission into park, engage parking brake and remove key.

### WHEN connecting and disconnecting implement hitch:

- DO NOT crawl or walk under raised mower or wing.
- USE tongue JACK to lift heavy implement tongues to control implement tongue movement.
- AVOID overloading jack to prevent jack failure and injury. (*Refer to Instructions in Operation Section*)

### WHEN CONNECTING IMPLEMENT DRIVELINE:

#### TO AVOID implement driveline coming loose during operation:

- **LUBRICATE** yoke spring locking collar to ensure it freely slides on PTO shaft.
- **SECURELY** seat yoke locking balls in PTO shaft groove.
- **PUSH** and **PULL DRIVELINE** on both the tractor and implement **PTO SHAFTS** to ensure it is **SECURELY ATTACHED**.

#### TO AVOID broken driveline during operations:

- **CHECK** driveline for proper length between PTO shaft and implement gearbox shaft. (*Refer to Instructions in Operation Section*)
- Drivelines too short can pull apart or disengage.
- Drivelines too long can bottom out.
- Bottoming driveline telescoping assembly will stop sliding and become solid.
- Driveline bottoming can push through support bearings and break off PTO shaft.

#### CONTACT DEALER if implement driveline does not match Tractor PTO shaft:

- **DO NOT USE PTO ADAPTER.**  
Using a PTO adapter can cause:
  - Excessive vibration, thrown objects, blade and implement failures by doubling operating speed.
  - Increased working length exposing unshielded driveline areas and entanglement hazards.

#### BEFORE REMOVING WING RETAINING LOCKS:



- **ATTACH** hoses to tractor.
- **FILL** Wing Cylinders with oil. (*Refer to Instructions in Operation Section*)
- **KEEP** bystanders clear of area before operating wings.
- **LOWER WINGS** slowly and carefully.

**DO NOT** connect the Mower to a tractor with the PTO directly connected to the Tractor transmission. *PN CD01*

**SAFETY**

# SAFETY

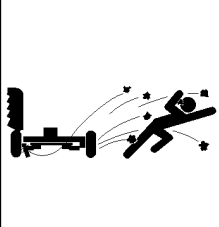
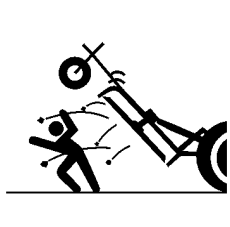
## THROWN OBJECTS HAZARDS

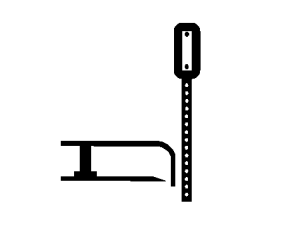
				
Mower Thrown Objects Hazard	Raised Mower Thrown Objects	Raised Mower Thrown Objects	Inspect Area remove foreign objects	Do not let blades contact solid objects



**ROTARY MOWERS CAN THROW OBJECTS 300 FEET OR MORE UNDER ADVERSE CONDITIONS.**

**TO AVOID SERIOUS INJURY OR DEATH TO OPERATOR OR BYSTANDERS FROM THROWN OBJECTS:**

- KEEP bystanders 300 feet away

**STOP MOWING IF PASSERSBY ARE WITHIN 300 FEET UNLESS:**

- **ALL THROWN OBJECT SHIELDING** including, Front and Rear Deflectors, Chains Guards, Steel Guards, Bands, Side Skirts and Skid Shoes in place and in good condition when mowing.
- Mower sections or wing are adjusted to be close and parallel to ground without exposing blades.
- **MOWING AREA** has been inspected and foreign materials and debris have been removed.
- **PASSERSBY** are inside enclosed vehicle.

**INSPECT AREA FOR POTENTIAL THROWN OBJECTS BEFORE MOWING:**

- **REMOVE** debris, rocks, wire, cable, metal objects and other foreign material from area.  
Wire, cable, rope, chains and metal objects can be thrown or swing outside deck with great velocity:
  1. **MARK** objects that cannot be removed.
  2. **AVOID** these objects when mowing.

**HIGH GRASS and WEED AREA INSPECTION:**

- **INSPECT** for and **REMOVE** any hidden large debris.
- **MOW** at Intermediate height
- **INSPECT** and remove remaining debris
- **MOW** at final height.

**MOWER THROWN OBJECT SHIELDING:**

- **KEEP** all thrown object shielding including, Front and Rear Deflectors, Chains Guards, Steel Guards, Bands, Side Skirts and Skid Shoes in place and in good condition when mowing.
- **DO NOT OPERATE** with any thrown object shielding missing, damaged or removed.

**RIGHT OF WAY (Highway) MOWING**

- **USE DOUBLE CHAIN GUARDS** for highway, right-of-way, parks or greenbelt mowing or all other mowing where human dwellings, vehicles, or livestock could be within 300 feet of the mower.
- No shielding is 100% effective in preventing thrown objects. To Reduce Possibility of Injury:
  1. **MAINTAIN MOWER SHIELDING**, side skirts, skid shoes, and blades in good operational condition,
  2. **RAISE CUTTING HEIGHT** to **6 INCHES** minimum,
  3. **INSPECT AREA** thoroughly before mowing to **REMOVE** potential **THROWN OBJECT HAZARDS**,
  4. **NEVER ALLOW BLADES to CONTACT SOLID OBJECTS** like wire, rocks, post, curbs, guardrails, or ground while mowing. *PN T001*

# SAFETY

## THROWN OBJECTS HAZARD (CONTINUED)

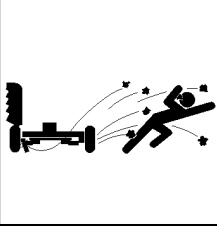
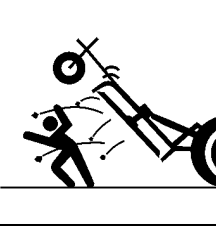
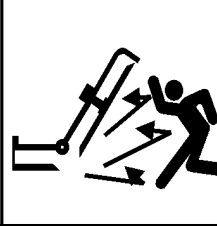
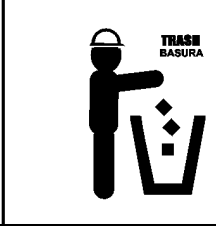
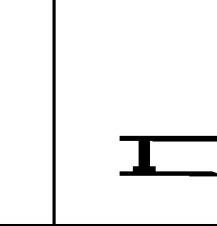
				
Mower Thrown Objects Hazard	Raised Mower Thrown Objects	Raised Mower Thrown Objects	Inspect Area remove foreign objects	Do not let blades contact solid objects

### MOWER OPERATION:

- **DO NOT** exceed mower's rated Cutting Capacity or cut non-vegetative material.
- **USE ENCLOSED TRACTOR CABS** when two or more mowers are operating in mowing area.
- Do Not mow in areas where bees or insects may attack unless you **WEAR PROTECTIVE CLOTHING** or use enclosed tractor cab.
- **ADJUST** mower sections or wing close and parallel to ground without exposing blades.
- **ADJUST** cutting **HEIGHT** to **AVOID BLADE CONTACT** with solid objects like wire, rocks, posts, curbs, guard rails and fixed obstructions.
- **DO NOT** operate mower when mower wing(s) is raised or in transport position.
- **STOP MOWING** immediately if blades strike heavy objects, fixed structures, metal guard rails and concrete structures:
  1. **BLADES CAN FAIL** from impact and objects can be thrown with great velocity.
  2. **INSPECT** and **REPLACE** any damaged blades.
  3. **CHECK** blade carrier and **REPLACE** if damaged.
- **DO NOT** mow in standing water **TO AVOID** possible **BLADE FAILURE**.
- **AVOID MOWING** in reverse:
  1. **STOP PTO** and back up mower.
  2. **LOWER** mower, engage **PTO** and mow forward.
- **STOP PTO** and **BLADES** when raising wings or the mower to transport position.
- **DO NOT ENGAGE PTO** with mower in transport position.
- **STOP** mowing when **EXCESSIVE VIBRATION** occurs:
  1. **STOP PTO** and tractor **ENGINE**.
  2. **INSPECT** mower for vibration source.
  3. **REPLACE** any damage parts and bent or damaged **BLADES**. *PN TO01-X*

**SAFETY**

# SAFETY

## RUN OVER HAZARDS

		
Operator run over hazard	Rider fall off run over hazard	Rider fall off run over hazard



**TO AVOID SERIOUS INJURY OR DEATH FROM FALLING OFF TRACTOR OR EQUIPMENT RUN OVER:**

- **USE ROPS** and **SEAT BELT** equipped tractors for mowing operations.
- **KEEP ROPS** locked in **UP** position.
- **ONLY** start tractor while seated in tractor seat.
- **ALWAYS BUCKLE UP** seat belt when operating tractor and equipment.
- **ONLY OPERATE** tractor and equipment while seated in tractor seat.
- **NEVER ALLOW RIDERS** on tractor or implement.

### **WHEN MOUNTING AND DISMOUNTING TRACTOR:**



- **ONLY** mount or dismount when tractor and moving parts are stopped.
- **STOP ENGINE AND PTO**, engage parking brake, lower implement, allow all moving parts to stop and remove key before dismounting from tractor. *PN R001*



# SAFETY

SAFETY

## PTO ENTANGLEMENT HAZARDS

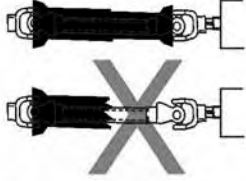
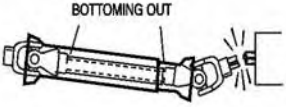
			
<p>Entanglement hazard Do Not approach or touch a rotating PTO driveshaft</p>	<p>Make sure PTO shaft is securely attached Do Not Use PTO Adapter</p>	<p>DO NOT Operate if PTO shields are damaged or missing</p>	<p>Make sure PTO shafts are proper length</p>



**KEEP AWAY FROM ROTATING DRIVELINES AND ELEMENTS TO AVOID SERIOUS INJURY OR DEATH:**

**STAY AWAY** and **KEEP** hands, feet and body **AWAY** from rotating blades, drivelines and parts until all moving elements have stopped.

- **STOP, LOOK** and **LISTEN** before approaching the mower to make sure all rotating motion has stopped.
- **ROTATING COMPONENTS CONTINUE** to **ROTATE** after the PTO is shut off.

### PTO SHIELDING:

#### TO AVOID SERIOUS INJURY OR DEATH FROM ENTANGLEMENT WHEN OPERATING IMPLEMENT:

- **KEEP PTO** shields, integral driveline shields and input shields installed
- **DO NOT OPERATE** mower without shields and guards in place or missing
- **REPAIR OR REPLACE** if damage, broken or missing
- **ALWAYS REPLACE GUARDS** that have been removed for service or maintenance.
- Do Not use PTO or PTO guard as a step.

#### TO AVOID broken driveline during operations:

- **CHECK** driveline for proper length between PTO shaft and implement gearbox shaft. (*Refer to Instructions in Operation Section*)
- Drivelines too short can pull apart or disengage.
- Drivelines too long can bottom out.  
Bottoming driveline telescoping assembly will stop sliding and become solid.
- Driveline bottoming can push through support bearings and break off PTO shaft
- **AVOID** sharp turns or lift mower to heights to cause driveline "knocking".
- Lubricate driveshaft-telescoping components weekly.

#### CONTACT DEALER if implement driveline does not match Tractor PTO shaft:



- **DO NOT USE PTO ADAPTER.**

Using a PTO adapter can cause excessive vibration, thrown objects, blade and implement failures by doubling operating speed. Increased working length exposing unshielded driveline areas. *PN PE01*

# SAFETY

SAFETY

## MOWER BLADE CONTACT HAZARDS

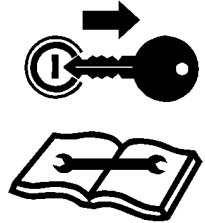

		
Do not put fingers underneath mower	Do not put foot underneath mower	Stop Tractor Remove Key Read Manual

**⚠ DANGER**

**KEEP AWAY FROM ROTATING BLADES TO AVOID SERIOUS INJURY OR DEATH FROM BLADE CONTACT:**

- **STAY AWAY** and **KEEP HANDS, FEET** and **BODY AWAY** from rotating blades, drivelines and parts until all moving elements have stopped.
- **DO NOT** put hands or feet under mower decks
- **STOP** rotating **BLADES** disengage PTO and wait for blade to stop rotating before raising mower deck or wings
- **STOP LOOK** and **LISTEN** before approaching the mower to make sure all rotating motion has stopped. *PN MB01*

## HIGH PRESSURE OIL LEAK HAZARD

		
High pressure oil penetrating skin	High pressure oil eroding skin	Using cardboard to check for oil leaks

**⚠ DANGER**

**TO AVOID SERIOUS INJURY OR DEATH FROM HIGH PRESSURE HYDRAULIC OIL LEAKS PENETRATING SKIN:**

- **DO NOT OPERATE** equipment with oil or fuel leaks.
- **KEEP** all hydraulic hoses, lines and connections in **GOOD CONDITION** and **TIGHT** before applying system pressure.
- **RELIEVE HYDRAULIC PRESSURE** before disconnecting lines or working on the system.
- **REMOVE** and replace hose if you suspect it leaks. Have dealer test it for leaks.



**HIGH PRESSURE FLUID LEAKS CAN BE INVISIBLE.**

**WHEN CHECKING FOR HYDRAULIC LEAKS AND WORKING AROUND HYDRAULIC SYSTEMS:**

- **ALWAYS WEAR** safety glasses and impenetrable gloves.
- **USE** paper or cardboard to search for leaks.
- **DO NOT USE** hands or body parts to search for leak.
- **KEEP** hands and body **AWAY** from pin holes and nozzles ejecting hydraulic fluid.
- Hydraulic fluid may cause gangrene if not surgically removed immediately by a doctor familiar with this form of injury. *PN HP01*

# SAFETY

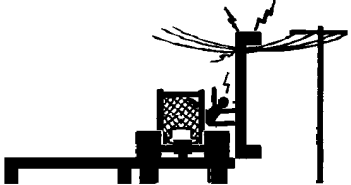
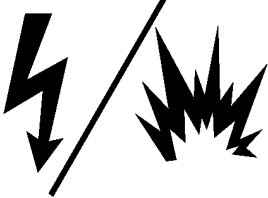
## ELECTRICAL & FIRE HAZARD

		
<p>Wing contacting overhead electrical lines</p>	<p>Strike and explosion Hazard Blades Contacting Utility or Gas Lines</p>	<p>Do not operate near fires. Keep mower deck clear of debris</p>

**⚠ DANGER**

**TO AVOID SERIOUS INJURY OR DEATH FROM ELECTRICAL CONTACT WHEN WORKING AROUND ELECTRICAL POWER LINES, GAS LINES AND UTILITY LINES:**

- **INSPECT** mowing area for overhead or underground electrical power lines, obstructions, gas lines, cables and Utility, Municipal, or other type structure.
- **KEEP** all raised wings at a 10 feet or greater distance from all power lines and overhead obstructions.
- **DO NOT** allow mower to contact with any Utility, Municipal, or type of structures and obstructions.
- **CALL 811** and 1-800-258-0808 for identify buried utility lines.





**FIRE PREVENTION GUIDELINES while Operating, Servicing, and Repairing Mower and Tractor to reduce equipment and grass fire Risk:**

- **EQUIP** Tractor with a **FIRE EXTINGUISHER**
- **DO NOT OPERATE** mower on a tractor equipped with under frame exhaust
- **DO NOT SMOKE** or have open flame near Mower or Tractor
- **DO NOT DRIVE** into burning debris or freshly burnt area
- **AVOID FIRE IGNITION** by not allowing mower blade to contact solid objects like metal or rock.
- **ADJUST SLIP CLUTCHES** to avoid excessive slippage and clutch plate heating.
- **CLEAR** any grass clippings or debris buildup around mower drivelines, slip clutches, and gearboxes.
- **SHUT OFF ENGINE** while refueling. *PN EF01*

**SAFETY**

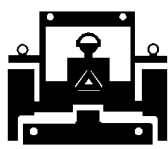
# SAFETY

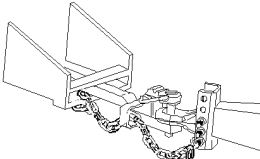
## TRANSPORTING HAZARDS

				
Use SMV signs and Flashing Lights	Loss of Control Stopping Hazard	Loss of Control Speeding Hazard	Use Safety Tow Chain - Tractor to Implement	Engage Transport Locks



**TO AVOID SERIOUS INJURY AND DEATH WHEN TOWING OR TRANSPORTING EQUIPMENT:**

- **KEEP** transport speed **BELOW** 20 mph to maintain control of equipment.
- **REDUCE SPEED** on inclines, on turns and in poor towing conditions.
- **DO NOT TOW** with trucks or other vehicles.
- **USE** only properly sized and equipped tractor for towing equipment.
- **FOLLOW** all local traffic regulations.

**TRACTOR REQUIREMENTS FOR TOWING OR TRANSPORTING IMPLEMENTS:**

- **ONLY TRANSPORT** with tractor with **ROPS** in the raised position.
- **USE** properly sized and equipped tractor that exceeds implement weight by at least 20%.
- **KEEP** 20% of tractor weight on front wheels to maintain safe steering.

**BEFORE TRANSPORTING OR TOWING IMPLEMENT:**

**TRACTOR INSPECTION:**

- **CHECK** steering and braking for proper operation and in good condition.
- **CHECK SMV** sign, reflectors and warning lights for proper operation and visibility behind unit.
- **CHECK** that your driving vision is not impaired by tractor, cab, or implement while seated in tractor seat.
- **ADJUST** your operating position, mirrors, and implement transport for clear vision for traveling and traffic conditions.

**PREPARE IMPLEMENT FOR TRANSPORTING OR TOWING:**

**ENGAGE TRANSPORT LOCKS AND SAFETY CHAINS:**

- **RAISE MOWER** and **ENGAGE** center axle cylinder transport stops or pins.
- **RAISE WINGS** and **ENGAGE TRANSPORT LOCKS** or pins.
- **ATTACH** implement **SAFETY CHAIN** to tractor.
- **REMOVE** any cut material collected on mower deck.

**DETERMINE STOPPING CHARACTERISTICS OF TRACTOR AND IMPLEMENT FOR TRANSPORTING OR TOWING:**

**BRAKING TESTS:**

- **INSTALL** center axle cylinder transport stops or pins.
- Observe **STOPPING** distances increases with increased speeds.
- **DETERMINE** the maximum safe transport speed that does not exceed 20 mph.

**DETERMINE MAXIMUM TURNING SPEED BEFORE OPERATING ON ROADS OR UNEVEN GROUND:**

- **TEST** equipment in slowly increasing speed in turns to determine it can be operated at higher speeds.
- **USE REDUCED** turning speeds in sharp turns to avoid equipment turning over.

**WHEN TOWING OR TRANSPORTING EQUIPMENT:**



- Always **WEAR SEAT BELT** when operating or transporting mower.
- **USE** low speeds to avoid overturn with raised wings.
- **USE** low speeds and gradual steering on curves, hills, rough or uneven surfaces and on wet roads.
- **TURN ON** tractor **FLASHING WARNING LIGHTS**.
- **ALLOW** clearance for implement swing while turning.

**KEEP all raised wings at 10 feet or greater distance from all power lines and overhead obstructions. PN TH01**

**SAFETY**

# SAFETY

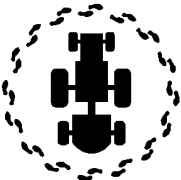
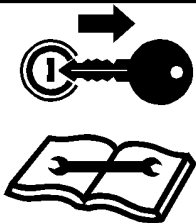
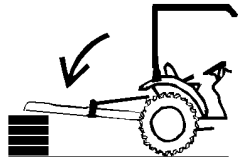
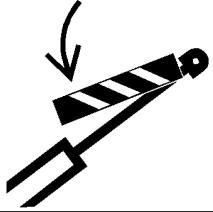
## HAZARDS WITH MAINTENANCE OF IMPLEMENT

				
Periodically inspect all moving parts, lubricate drivelines, and tighten all fasteners	Stop engine remove key before conducting maintenance	Block up implement before servicing Use large blocks on soft or wet soil	Engage cylinder transport locks	Inspect Blades for damage or cracks



**AVOID SERIOUS INJURY OR DEATH FROM COMPONENT FAILURE BY KEEPING IMPLEMENT IN GOOD OPERATING CONDITION IN PERFORMING PROPER SERVICE, REPAIRS AND MAINTENANCE.**

**BEFORE PERFORMING SERVICE, REPAIRS AND MAINTENANCE ON THE IMPLEMENT:  
SECURE EQUIPMENT FOR SERVICE**

**BLOCK OUT POTENTIAL ENERGY HAZARDS; Rotating Parts, Raised Components, Hydraulic Pressure.**

- **STOP ENGINE AND PTO**, engage parking brake, lower implement, allow all moving parts to stop and remove key before dismounting from tractor.
- **PLACE** implement on ground or securely block up raised equipment. Use large blocks on soft or wet soil.
- **SECURELY LATCH** and **LOCK** raised implement wings
- **BLOCK UP IMPLEMENT TONGUE** with large blocks and tongue jack. **DO NOT** crawl or work under implement supported only by tongue jack.
- **PUSH** and **PULL** Remote Hydraulic Cylinder lever to relieve hydraulic pressure.
- **DISCONNECT IMPLEMENT** Hydraulic **HOSES** from tractor
- **DISCONNECT IMPLEMENT** driveline from tractor **PTO SHAFT**.

**WEAR SAFETY GLASSES, PROTECTIVE GLOVES** and follow **SAFETY PROCEDURES** when performing service, repairs and maintenance on the implement:

- Always **WEAR** protective **GLOVES** when handling blades, knives, cutting edges or worn component with sharp edges.
- Always **WEAR GLOVES** and **SAFETY GLASSES** when servicing hot components
- **AVOID CONTACT** with hot hydraulic oil tanks, pumps, motors, valves and hose connection surfaces.
- **SECURELY** support or **BLOCK UP** raised implement, framework and lifted components before working underneath equipment.
- **STOP** any implement movements and **SHUT-OFF TRACTOR** engine before doing any work procedures.
- **USE** ladder or raised stands to reach high equipment areas inaccessible from ground.
- **ENSURE** good footing by standing on solid flat surfaces when getting on implement to perform work.
- **FOLLOW** manufacturer's instructions in handling oils, solvents, cleansers, and other chemical agents.
- **DO NOT** change any factory-set hydraulic calibrations to avoid component or equipment failures.
- **DO NOT** modify or alter implement, functions or components.
- **DO NOT WELD** or repair rotating mower components. These may cause vibrations and component failures being thrown from mower.

**PERFORM SERVICE, REPAIRS, LUBRICATION AND MAINTENANCE OUTLINED IN IMPLEMENT MAINTENANCE SECTION:**

- **INSPECT** for loose fasteners, worn or broken parts, leaky or loose fittings, missing or broken cotter keys and washers on pins, and all moving parts for wear.
- **REPLACE** any worn or broken parts with authorized service parts.
- **LUBRICATE** unit as specified by lubrication schedule
- **NEVER** lubricate, adjust or remove material while it is running or in motion.
- **TORQUE** all bolts and nuts as specified.

**BLADE INSPECTION:**

- **REPLACE** bent, damage, cracked or broken blades immediately with new blades.
- **AVOID** blade failures and thrown broken blades. **DO NOT** straighten, weld, or weld hard-facing blades.

**SAFETY SHIELDS, GUARDS AND SAFETY DEVICES INSPECTION:**

- **KEEP** all Deflectors, Chain Guards, Steel Guards, Gearbox Shields, and PTO integral shields, Bands, Side Skirts and Skid Shoes in place and in good condition.
- **REPLACE** any missing, broken or worn safety shields, guards and safety devices.
- Engine Exhaust, some of its constituents, and certain vehicle components contain or emit chemicals known to the state of California to cause cancer, birth defects or other reproductive harm.
- Battery posts, terminals and related accessories contain lead and lead compounds, chemicals known to the state of California to cause cancer, birth defects or other reproductive harm. **PN HM01**

**SAFETY**

# SAFETY

## **PARTS INFORMATION**

### PARTS INFORMATION

Bush Hog mowers use balanced and matched system components for blade carriers, blades, cuttershafts, knives, knife hangers, rollers, drivetrain components, and bearings. These parts are made and tested to Bush Hog specifications. Non-genuine "will fit" parts do not consistently meet these specifications. The use of "will fit" parts may reduce mower performance, void warranties, and present a safety hazard. Use genuine Bush Hog mower parts for economy and safety. (SPBH-1)

**SEE YOUR BUSH HOG DEALER**

Operator's & Parts Manuals



[www.algqr.com/bpm](http://www.algqr.com/bpm)

SAFETY

# SAFETY

## Decal Location

**NOTE:** Bush Hog supplies safety decals on this product to promote safe operation. Damage to the decals may occur while in shipping, use, or reconditioning. Bush Hog cares about the safety of its customers, operators, and bystanders, and will replace the safety decals on this product in the field, free of charge (Some shipping and handling charges may apply). Contact your Bush Hog dealer to order replacement decals.

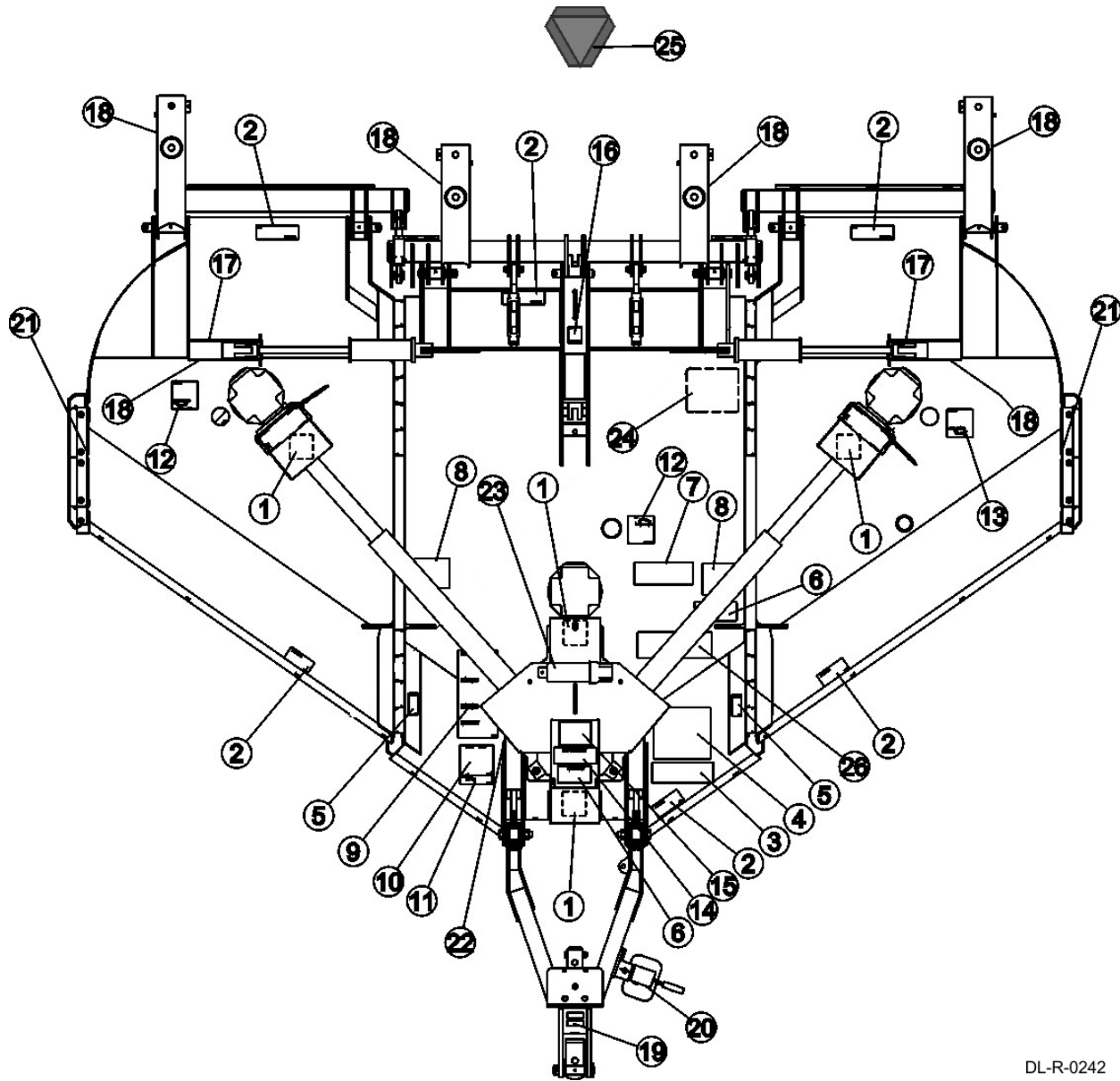

**SAFETY**

DL-R-0242

# SAFETY

**SAFETY**

ITEM	PART NO.	QTY	TYPE	DESCRIPTION
1.	D546	4	DANGER	Rotating Driveline
2.	D614	6	DANGER	Thrown Object Shield Missing
3.	D587	1	INSTRUCT	Lubrication
4.	D549	1	DANGER	Multi Hazard
5.	D555	2	DANGER	Shield Missing
6.	91443	2	IMPORTANT	Slip Clutch
7.	D559	1	WARNING	Use Bush Hog Genuine Parts
8.	D565	2	DANGER	Crushing Hazard
9.	D553	1	WARNING	Hydraulic Pressure/Towing
10.	D547	1	DANGER	540 RPM
11.	D548	1	DANGER	1000 RPM
12.	D551	2	WARNING	Torque Bolts/Blade Rotation CCW
13.	D552	1	WARNING	Torque Bolts/Blade Rotation CW
14.	87340	1	IMPORTANT	Driveline Lube
15.	50058285	1	INSTRUCT	Gearbox Warranty
16.	D544	1	IMPORTANT	Transport Latch
17.	50031214	2	REFLECT	Red
18.	50031212	6	REFLECT	Amber
19.	50035874	1	INSTRUCT	This Side Up
20.	D762	1	WARNING	Jackstand
21.	50061049	2	LOGO	Bush Hog
22.	50069419	2	MODEL	2815
	50069420	2	MODEL	12815
	50070506	2	MODEL	2810
	50070507	2	MODEL	12810
23.	50035829	1	IMPORTANT	Manual Canister
24.	D575	1	DANGER	Crushing Hazard
25.	94359	1	REFLECT	SMV
26.	D813	1	DANGER	Multi Language



# SAFETY

## Decal Description

**! DANGER**



**THROWN OBJECTS HAZARD** D549\_1

**Mower can throw objects up to 300 feet. TO AVOID SERIOUS INJURY OR DEATH to operator or bystanders:**

- STOP mowing if bystanders or traffic come within 300 feet.
- DO NOT OPERATE with thrown object shielding removed.
- KEEP thrown object shielding in place and in good condition during operation. Thrown Objects shielding is subject to wear.
- REPAIR OR REPLACE shielding if damaged, broken or missing. See Operator's Manual for all Shields and Guards.
- INSPECT area for potential mower thrown object hazards before mowing.
- Remove and AVOID objects such as wire, cable, metal objects and all other foreign material.
- DO NOT ALLOW blades to contact solid objects like wire, rocks, posts, curbs or guard rails.
- DO NOT OPERATE in transport position or with wings off ground.

**! DANGER**



**Run Over Hazard - Injury or Death**

**TO AVOID SERIOUS INJURY OR DEATH:**

- ALWAYS BUCKLE UP seat belt.
- ONLY START Tractor while seated in the operator's seat.
- STOP ENGINE and PTO, engage parking brake, lower implement, allow all moving parts to stop and remove key before dismounting from tractor.
- KNOW HOW to stop tractor and equipment quickly for an emergency.
- DO NOT MOUNT or DISMOUNT Tractor in motion.
- NEVER ALLOW riders on tractor or implement.
- NEVER ALLOW children to operate or ride on tractor or implement.
- KEEP BYSTANDERS CLEAR of area before moving tractor or implement.
- KEEP ALERT and AVOID hitting stumps, holes, ruts, and uneven terrain.
- AVOID tree limbs, brush and other overhanging objects that can strike and throw the operator from seat.

D549\_4  
D549\_1B

# SAFETY

SAFETY

<b>⚠ DANGER</b>	
<b>ENTANGLEMENT HAZARD</b>	
<p><b>TO AVOID SERIOUS INJURY OR DEATH:</b></p> <ul style="list-style-type: none"> <li>• DO NOT operate without guards in place and in good condition. PTO and gearbox guarding are SUBJECT TO WEAR.</li> <li>• STAY AWAY and KEEP hands, feet and body AWAY from rotating blades, drivelines and parts that continue to move after power shut-off. WAIT until all moving elements have stopped.</li> <li>• ALWAYS REPLACE GUARDS that have been removed for service or maintenance.</li> <li>• STOP, LOOK and LISTEN for rotating motion before approaching implement.</li> <li>• DO NOT STEP ON drivelines or guards.</li> </ul> <p style="text-align: right;">D549_2</p>	



Tractor PTO Guard

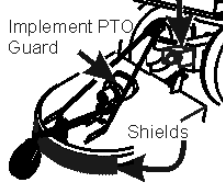

Implement PTO Guard

Shields

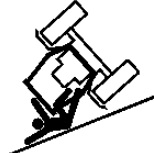
<b>⚠ DANGER</b>	
<b>Crushing Hazard - Injury or Death</b>	
<p><b>TO AVOID SERIOUS INJURY OR DEATH:</b> <span style="float: right;">D549_3</span></p> <ul style="list-style-type: none"> <li>• USE tractor equipped with <b>R</b>ollover <b>P</b>rotective <b>S</b>tructure ("ROPS") including roll bar and seat belt. Keep roll bar in raised position.</li> <li>• STAND CLEAR when removing transport latch, lowering or raising wings.</li> <li>• IMPLEMENT CAN FALL from hydraulic failure or accidental operation of controls.</li> <li>• BLOCK UP and securely support equipment before putting hands, feet or body under raised equipment or lifted components.</li> </ul>	

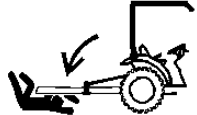

<b>⚠ DANGER</b>			
	 <p style="text-align: center; font-size: small;">www.algqr.com/bme</p>		
<p><b>TO AVOID SERIOUS INJURY OR DEATH:</b> <span style="float: right;">D549_5</span></p> <ul style="list-style-type: none"> <li>• READ AND UNDERSTAND the provided Operator's Manuals, safety signs and information decals for tractor and implement before operating equipment.</li> <li>• CONTACT DEALER immediately if you do not have manuals.</li> <li>• CONTACT DEALER to explain any instructions not fully understood.</li> <li>• ALWAYS WEAR safety glasses.</li> <li>• WEAR hard hat, safety shoes and gloves for protection when operating equipment.</li> </ul> <p style="text-align: right;">D549</p>			

D549\_2B

# SAFETY

## ⚠ WARNING



### TO AVOID SERIOUS INJURY OR DEATH FROM HIGH PRESSURE HYDRAULIC OIL LEAKS PENETRATING SKIN:

- DO NOT OPERATE equipment with oil or fuel leaks.
- KEEP all hydraulic hoses, lines and connections in good condition and tight before applying system pressure.
- Relieve hydraulic pressure before disconnecting lines or working on the system.
- REMOVE and replace hose if you suspect it leaks. Have dealer test it for leaks.

### HIGH PRESSURE FLUID LEAKS CAN BE INVISIBLE. WHEN CHECKING FOR HYDRAULIC LEAKS AND WORKING AROUND HYDRAULIC SYSTEMS:

- DO NOT use hands to check for leaks.
- ALWAYS WEAR safety glasses and impenetrable gloves.
- USE paper or cardboard to search for leaks.
- KEEP hands and body AWAY from pin holes and nozzles ejecting hydraulic fluid.
- Hydraulic fluid may cause gangrene if not surgically removed immediately by a doctor familiar with this form of injury.

D553\_1

## ⚠ WARNING

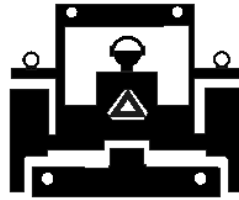
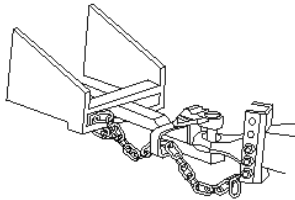

### TO AVOID SERIOUS INJURY AND DEATH WHEN TOWING EQUIPMENT:

- DO NOT TOW with trucks or other vehicles.
- ONLY transport with properly sized and equipped tractor. (see Operator's Manual)
- ATTACH implement SAFETY CHAIN to tractor.
- CHECK SMV sign, reflectors and warning lights for visibility behind unit.
- TURN ON tractor flashing warning lights.

### TO AVOID LOSS OF TOWING CONTROL:

- DO NOT tow at speeds over 20 mph.
- REDUCE SPEED on inclines, in turns and in poor towing conditions.

D553\_2

D553\_1B

# SAFETY

SAFETY

## ⚠ WARNING

### TO AVOID EQUIPMENT AND GRASS FIRES:

- CLEAR AWAY grass or debris from slip clutches, gearboxes, drivelines and decks.

### TO AVOID FIRE IGNITION:

- DO NOT ALLOW BLADES TO CONTACT rocks, metal or solid objects.

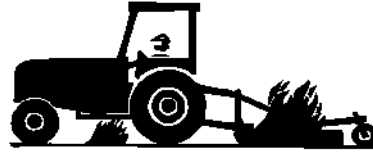

D553\_3

## IMPORTANT

Required for Standard Pull Type Units.

D553\_4

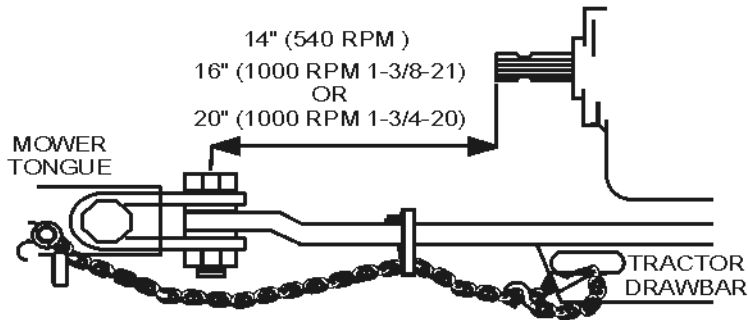

Attach Safety Chain securely.

D553

D553\_2B

## ⚠ WARNING

OPERATE THIS MACHINE AT

# 1000 RPM

TRACTOR PTO SPEED ONLY.

Overspeeding PTO may cause component failure resulting in bodily injury.

TRACTOR PTO ROTATION: CLOCKWISE

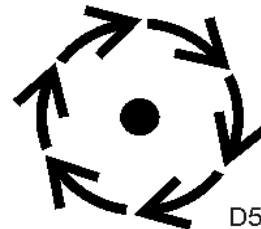



D548

D548 B

# SAFETY

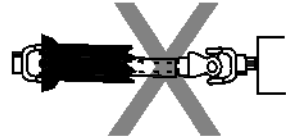
SAFETY

<b>⚠ DANGER</b>		
		
<p><b>TO AVOID SERIOUS INJURY OR DEATH FROM DRIVELINE CONTACT, DRIVELINE SEPARATION OR PTO STUB SHAFT FAILURE:</b></p> <ul style="list-style-type: none"><li>● STOP, LOOK and LISTEN for rotating motion before approaching implement.</li><li>● STAY AWAY and KEEP hands, feet and body AWAY from rotating parts until all moving elements have stopped.</li><li>● ALWAYS shut off PTO before dismounting.</li><li>● DO NOT operate if PTO shields are damaged or missing.</li><li>● PUSH AND PULL on yoke until collar clicks and locks yoke in place.</li><li>● CHECK driveline guards for free rotation and sufficient overlap to avoid unshielded areas.</li><li>● DO NOT USE PTO ADAPTER</li></ul>		
		
<b>⚠ WARNING</b>		
<p>OPERATE THIS MACHINE AT <b>540 RPM</b> TRACTOR PTO SPEED ONLY. Overspeeding PTO may cause component failure resulting in bodily injury. TRACTOR PTO ROTATION: CLOCKWISE</p>	 D547	

D547 B

# SAFETY



SAFETY

## **! DANGER**

### **Crushing Hazard - Injury or Death**

**TO AVOID SERIOUS INJURY OR DEATH:**

- **STAND CLEAR** when removing transport latch, lowering or raising wings.
- **CLEAR AREA** of bystanders before lowering implement wings.
- **IMPLEMENT CAN FALL** from hydraulic failure or accidental operation of controls.
- **BLOCK UP** and securely support equipment before putting hands, feet or body under raised equipment or lifted components.
- **SECURELY ENGAGE** transport latch before transportation or working under wing.
- **FILL CYLINDERS** with oil before attempting to lower implement wings.
- **DO NOT OPERATE** in transport position or with wings off ground.



D565

D565\_B

## **! DANGER**



D546

### **GUARD MISSING DO NOT OPERATE**

D546\_B

## **! DANGER**



### **Crushing Hazard**

**Transport Latch  
RAISE AND  
SECURELY LOCK  
Wing Transport Latch  
before transporting  
mower on roadways  
or working under  
wing.**

D555

D555\_B

# SAFETY

SAFETY

**⚠ WARNING**

**TO AVOID SERIOUS INJURY OR DEATH FROM BLADE ATTACHMENT FAILURE:**

- Torque blade bolt to 600 ft lbs.
- ALWAYS replace blades in pairs.
- ALWAYS replace blades with new bolts and nuts.

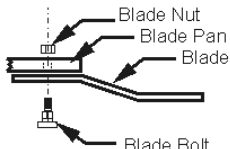

D551

**BLADE ROTATION**



D551\_B

**⚠ WARNING**

**TO AVOID SERIOUS INJURY OR DEATH FROM BLADE ATTACHMENT FAILURE:**

- Torque blade bolt to 600 ft lbs.
- ALWAYS replace blades in pairs.
- ALWAYS replace blades with new bolts and nuts.

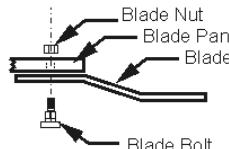

D552

**BLADE ROTATION**



D552\_B

**⚠ WARNING**

**Non-genuine parts can fail catastrophically. TO AVOID SERIOUS INJURY OR DEATH:**

- ONLY use genuine Bush Hog replacement parts.
- Non-genuine parts can fail creating hazardous conditions for operator and bystanders.



Contact local dealer or Bush Hog about repair parts at:  
2501 Griffin Ave., Selma, AL 36701  
Customer Service: 800-363-6096.  
Email: [contactus@bushhog.com](mailto:contactus@bushhog.com) [www.algqr.com/bpm](http://www.algqr.com/bpm)

D559\_1

**IMPORTANT**

**BE AWARE BE ALERT BE ALIVE** **BE TRAINED Before Operating this Mower**



To prevent serious injury to yourself and/or bystanders, be trained in Safe Mowing Practices. Alamo Group Companies as well as AEM and FEMA provide training material that is critical for your Safety and the Safety of others when operating this equipment. [www.algqr.com/bve](http://www.algqr.com/bve)  
Make these Safety Procedures an important part of every workday. Read and understand the Operator's Manual. Do not let untrained individuals operate this equipment. Contact your Dealer, AEM ([www.aem.org](http://www.aem.org)), FEMA (314-878-2304, [www.FarmEquip.org](http://www.FarmEquip.org)), or Alamo Group ([www.Alamo-Group.com](http://www.Alamo-Group.com)) for information on training material or courses that provide training in Safer Operating Practices for Mowers. D559\_2

D559

**IMPORTANT**

**TRANSPORT LATCH**  
Securely lock Transport Latch before transporting mower on roadway or working under implement.

D544

D544\_B

# SAFETY

SAFETY

## ! PELIGRO

Si no puede leer inglés: antes de poner en funcionamiento este equipo, solicite que alguien le traduzca los mensajes de seguridad o vaya al sitio web para consultar los mensajes de seguridad y las etiquetas ya traducidos.

El Manual del Operador Seguridad vídeo



[www.algqr.com/bms](http://www.algqr.com/bms) [www.algqr.com/bvs](http://www.algqr.com/bvs)

## ! DANGER

Si vous ne savez pas lire le français: avant d'utiliser l'équipement, demandez à une personne de vous traduire les messages de sécurité ou allez sur le site Internet pour voir la traduction des autocollants et des messages de sécurité.

Manuel de l'Opérateur



D813\_1 [www.algqr.com/bmf](http://www.algqr.com/bmf)

## ! PERIGO

Caso você não leia inglês: antes de operar o equipamento, peça para alguém traduzir as mensagens de segurança ou visite a web e obtenha tais mensagens ou os decalques traduzidos.

Manual do Operador



[www.algqr.com/bmp](http://www.algqr.com/bmp)

## ! GEFAHR

Falls Sie Deutsch nicht lesen können: Lassen Sie sich, bevor Sie das Gerät in Betrieb nehmen, die Sicherheitshinweise von einer geeigneten Person in Ihre Sprache übersetzen. Oder suchen Sie auf unserer Website nach Übersetzungen von Schilderaufschriften und Sicherheitshinweisen.

Benutzerhandbuch



D813\_2 [www.algqr.com/bmg](http://www.algqr.com/bmg)



# SAFETY

SAFETY

**⚠ DANGER**

**THROWN OBJECT HAZARD**

**TO AVOID SERIOUS INJURY OR DEATH:**  
DO NOT OPERATE if Thrown Object Shielding is damaged or missing.

MAINTAIN Thrown Object Shielding

HERE

D614

D614 B

**⚠ WARNING**

D762

Rated Vertical Loads	3000 lbs
Side Loads	675 lbs

**TO AVOID SERIOUS INJURY:**

- Fully engage jack retaining pin.
- Adjust jack vertically.
- Torque positioning nut to 150 ft-lbs.
- DO NOT exceed rated loads.

**⚠ DANGER**

Without weight

With weight

**Crushing Hazard - Injury or Death**

**CENTER SECTION MAY LIFT AND TURN OVER WITHOUT COUNTER WEIGHT. TO AVOID SERIOUS INJURY OR DEATH:**

- DO NOT OPERATE without counterweight.
- DO NOT LIFT WING without counterweight.
- Install a counterweight with a minimum of 700 lbs before operating.

D575

**⚠ WARNING**

**EXPLOSION HAZARD**

**RELEASE ALL AIR PRESSURE BEFORE LOOSENING BOLTS. FAILURE TO DO SO COULD RESULT IN SERIOUS INJURY OR DEATH**

MAX. SPEED: 20 MPH, MAX. WEIGHT: 4000 LBS., MAX. AIR PRESSURE: 40PSI

1006348

# SAFETY

## Federal Laws and Regulations

This section is intended to explain in broad terms the concept and effect of federal laws and regulations concerning employer and employee equipment operators. This section is not intended as a legal interpretation of the law and should not be considered as such.

### Employer-Employee Operator Regulations

U.S. Public Law 91-596 (The Williams-Steiger Occupational and Health Act of 1970) OSHA

#### This Act Seeks:

"...to assure so far as possible every working man and woman in the nation safe and healthful working conditions and to preserve our human resources..."

#### DUTIES

Sec. 5 (a) Each employer-

- (1) shall furnish to each of his employees employment and a place of employment which are free from recognized hazards that are causing or are likely to cause death or serious physical harm to his employees;
- (2) shall comply with occupational safety and health standards promulgated under this Act.
- (b) Each employee shall comply with occupational safety and health standards and all rules, regulations and orders issued pursuant to this Act which are applicable to his own actions and conduct.

### OSHA Training Requirements

**Title 29, Code of Federal Regulations Part 1928.57(a)(6).** [www.osha.gov](http://www.osha.gov)

Operator instructions. At the time of initial assignment and at least annually thereafter, the employer shall instruct every employee who operates an agricultural tractor and implements in the safe operating practices and servicing of equipment with which they are or will be involved, and of any other practices dictated by the work environment.

Keep all guards in place when the machine is in operation;

Permit no riders on equipment

Stop engine, disconnect the power source, and wait for all machine movement to stop before servicing, adjusting, cleaning or unclogging the equipment, except where the machine must be running to be properly serviced or maintained, in which case the employer shall instruct employees as to all steps and procedures which are necessary to safely service or maintain the equipment.

Make sure everyone is clear of machinery before starting the engine, engaging power, or operating the machine.

### Employer Responsibilities:

To ensure employee safety during Tractor and Implement operation, it is the employer's responsibility to:

1. Train the employee in the proper and safe operation of the Tractor and Implement.
2. Require that the employee read and fully understand the Tractor and Implement Operator's manual.
3. Permit only qualified and properly trained employees to operate the Tractor and Implement.
4. Maintain the Tractor and Implement in a safe operational condition and maintain all shields and guards on the equipment.
5. Ensure the Tractor is equipped with a functional ROPS and seat belt and require that the employee operator securely fasten the safety belt and operate with the ROPS in the raised position at all times.
6. Forbid the employee operator to carry additional riders on the Tractor or Implement.
7. Provide the required tools to maintain the Tractor and Implement in a good safe working condition and provide the necessary support devices to secure the equipment safely while performing repairs and service.
8. Require that the employee operator stop operation if bystanders or passersby come within 300 feet.

### Child Labor Under 16 Years of Age

Some regulations specify that no one under the age of 16 may operate power machinery. It is your responsibility to know what these regulations are in your own area or situation. (Refer to U.S. Dept. of Labor, Employment Standard Administration, Wage & Home Division, Child Labor Bulletin #102.)

# **INTRODUCTION SECTION**

Introduction Section 2-1

# INTRODUCTION

We are pleased to have you as a Bush Hog customer. Your Rotary Cutter has been carefully designed with care and built with quality materials by skilled workers to give maximum service with minimum down time. This manual is provided to give you the necessary operating and maintenance instructions for keeping your rotary cutter in top operating condition. Careful use and timely service saves extensive repairs and costly downtime losses. Please read this manual thoroughly. Understand what each control is for and how to use it.

Bush Hog typically offers three types of shielding to protect the operator, passerby, livestock, and property from thrown objects... deflectors, single chain guards, and double chain guards. Shielding should be selected based on the intended use of the mower. Double chain guards or deflectors should be used for highway, right-of-way, parks or greenbelt mowing or all other mowing where human dwellings, vehicles, or livestock could be within 300 feet of the mower. Chain guards are more durable, provide a longer service life and require less maintenance and replacement than deflectors. Single chain guards may be sufficient for agriculture and other mower use only where passersby or property are not within 300 feet of the mower during operation.

No shielding is 100% effective in preventing thrown objects. The possibility of injury and property damage from this hazard can be substantially reduce by selecting proper shielding, maintaining the mower and shielding in good operational condition, inspecting the area for foreign debris before mowing, operating the mower at a minimum cutting height of 6", and keep unprotected persons at a minimum distance of 300 feet from the mower at all times during operation.

Safety is of primary importance to the owner/operator and to the manufacturer. Observe all safety precautions decaled on the machine and noted throughout the manual for safe operation of implement. If any assistance or additional information is needed, contact your authorized Bush Hog dealer. The owner/operator/dealer should know and understand the Safety Messages before assembly and be aware of the hazards of operating this cutter during assembly, use, and maintenance. The Safety Alert Symbol combined with a Signal Word, as seen below, is intended to warn the owner/operator of impending hazards and the degree of possible injury faced when operating this machine.



Indicates an imminently hazardous situation that, if not avoided, WILL result in DEATH OR VERY SERIOUS INJURY.



Indicates an imminently hazardous situation that, if not avoided, COULD result in DEATH OR SERIOUS INJURY.



Indicates an imminently hazardous situation that, if not avoided, MAY result in MINOR INJURY.



Identifies special instructions or procedures that, if not strictly observed, could result in damage to, or destruction of the machine, attachments

# INTRODUCTION

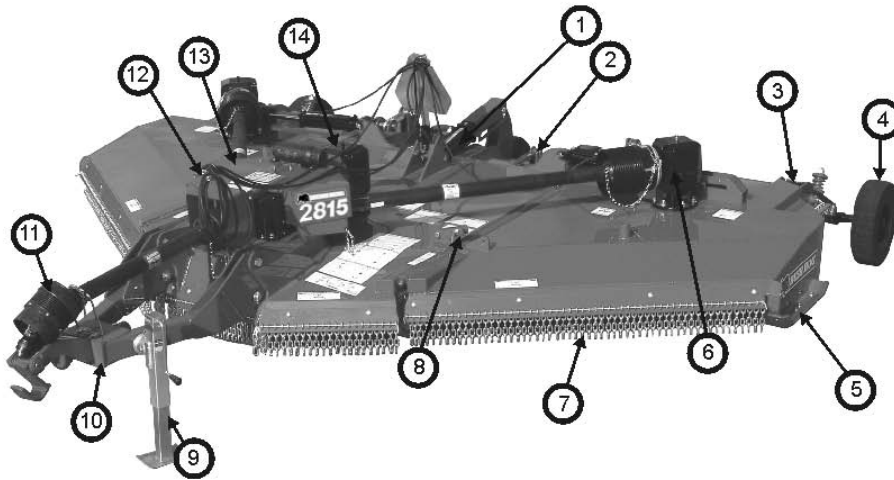

- 1 Height Adjustment Cylinder
- 2 Tongue Height Adjustment
- 3 Axle
- 4 Laminated Tire
- 5 Replaceable Wing Skid
- 6 Wing Blade Gearbox
- 7 Discharge Shield (Chains)
- 8 Wing Transport Lock
- 9 Jackstand
- 10 Tongue
- 11 CV Driveline
- 12 Hose Holder Rod
- 13 Power Divider Gearbox (Under Shield)
- 14 Center Blade Gearbox

**NOTE:** All references made in this manual to right, left, front, rear, top or bottom are as viewed facing the direction of forward travel with implement properly attached to tractor.

The Model 2815 Rotary Cutter consists of a center unit with two variable position wings together having a cutting width of 15 feet (4.6m). The Model 2810 Rotary Cutter consists of a center unit with one variable position wing together having a cutting width of 10-1/2 feet (3.2m). Wing operating angles and machine cutting height are independently controlled using hydraulic cylinders. A self-leveling linkage maintains a level cutter at all cutting heights.

Power from the tractor PTO is split at the power divider gearbox and supplied to each of the blade gearboxes. Each blade gearbox has two free-swinging uplift blades designed to cut grass, corn stalks and light brush. Free-swinging blades reduce the shock of impact when a stationary object is hit. Slip clutches are installed on each gearbox for additional protection. Front and rear discharge shields are included as standard equipment.

Literature Page



[www.algqr.com/ble](http://www.algqr.com/ble)

## Equipment Specifications<sup>2</sup>

	2815-2	2810-2		2815-2/2810-2	12815-2/12810-2
Cutting Width	15'	10'	<b>Blade Tip Speed</b>	<b>540 PTO</b>	<b>1000 PTO</b>
Transport Width	111"	106"	Center	16,000 FPM	16,000 FPM
Overall Width	186"	142"	Wings	16,000 FPM	16,000 FPM
Overall Length	193"	193"	<b>Gearbox Rating</b>		
Cutting Height	2" -14"	2" -14"	Power Divider	250 HP	250 HP
HP Required (min)	60HP	60HP	Center & Wings	210 HP	210 HP
Cutting Capacity (max)	4"	4"	Limited Warranty	6 Year	6 Year
Drawbar Load Rating (min)	2,108 lbs	2,108 lbs	<b>Driveline Size</b>		
Wing Flex Up	87°	87°	Main	CAT 5	CAT 5
Wing Flex Down	22°	22°	Wings	CAT 4	CAT 4

# INTRODUCTION

## KEY OPERATION POINTS

- Cutting performance and distribution are best when cutter is level from side to side. Mower front to rear pitch should be 1" or less.
- In extra heavy material, rear chains will allow better discharge and better distribution than solid rear deflectors or bands.
- Never operate the Flexwing below full PTO speed of 540 or 1000 rpm.
- For good distribution, the distribution baffles must be used.
- Make sure PTO driveline slip clutches are not frozen and are properly adjusted.
- To reduce uneven grass cutting and streaking.
  - make sure tractor rear tire spacing is a minimum of 60" between the inside of the tires.
  - make sure blades are not bent and are in good condition.
  - reduce ground speed to allow more cutting time.
- If Tractor engine is lugging down, shift tractor to a lower gear
- ALWAYS OPERATE WITH THE WING HYDRAULIC CYLINDER CONTROL VALVES IN A FLOAT POSITION.
- For maximum performance and service life, Always use Genuine Bush Hog replacement parts

# INTRODUCTION

## LIMITED WARRANTY



Bush Hog warrants to the original purchaser of any new Bush Hog equipment, purchased from an authorized Bush Hog dealer, that the equipment be free from defects in material and workmanship for a period of one (1) year for non-commercial, state and municipalities' use and ninety (90) days for commercial use from date of retail sale. The obligation of Bush Hog to the purchaser under this warranty is limited to the repair or replacement of defective parts.

Replacement or repair parts installed in the equipment covered by this limited warranty are warranted for ninety (90) days from the date of purchase of such part or to the expiration of the applicable new equipment warranty period, whichever occurs later. Warranted parts shall be provided at no cost to the user at an authorized Bush Hog dealer during regular working hours. Bush Hog reserves the right to inspect any equipment or parts which are claimed to have been defective in material or workmanship.

### DISCLAIMER OF IMPLIED WARRANTIES & CONSEQUENTIAL DAMAGES

Bush Hog's obligation under this limited warranty, to the extent allowed by law, is in lieu of all warranties, implied or expressed, **INCLUDING IMPLIED WARRANTIES OF MERCHANTABILITY AND FITNESS FOR A PARTICULAR PURPOSE** and any liability for incidental and consequential damages with respect to the sale or use of the items warranted. Such incidental and consequential damages shall include but not be limited to: transportation charges other than normal freight charges; cost of installation other than cost approved by Bush Hog; duty; taxes; charges for normal service or adjustment; loss of crops or any other loss of income; rental of substitute equipment, expenses due to loss, damage, detention or delay in the delivery of equipment or parts resulting from acts beyond the control of Bush Hog.

### THIS LIMITED WARRANTY SHALL NOT APPLY:

1. To vendor items which carry their own warranties, such as engines, tires, and tubes.
2. If the unit has been subjected to misapplication, abuse, misuse, negligence, fire or other accident.
3. If parts not made or supplied by Bush Hog have been used in connection with the unit, if, in the sole judgement of Bush Hog such use affects its performance, stability or reliability.
4. If the unit has been altered or repaired outside of an authorized Bush Hog dealership in a manner which, in the sole judgement of Bush Hog, affects its performance, stability or reliability.
5. To normal maintenance service and normal replacement items such as gearbox lubricant, hydraulic fluid, worn blades, or to normal deterioration of such things as belts and exterior finish due to use or exposure.
6. To expendable or wear items such as teeth, chains, sprockets, belts, springs and any other items that in the company's sole judgement is a wear item.

NO EMPLOYEE OR REPRESENTATIVE OF BUSH HOG IS AUTHORIZED TO CHANGE THIS LIMITED WARRANTY IN ANY WAY OR GRANT ANY OTHER WARRANTY UNLESS SUCH CHANGE IS MADE IN WRITING AND SIGNED BY BUSH HOG'S SERVICE MANAGER, 2501 GRIFFIN AVE., SELMA, ALABAMA 36703.



Record the model number, serial number and date purchased. This information will be helpful to your dealer if parts or service are required.

MODEL NUMBER \_\_\_\_\_

SERIAL NUMBER \_\_\_\_\_

DATE OF RETAIL SALE \_\_\_\_\_

MAKE CERTAIN THE WARRANTY HAS BEEN FILED WITH BUSH HOG SELMA, ALABAMA





# **ASSEMBLY SECTION**

Assembly Section 3-1

# ASSEMBLY

## DEALER SET-UP INSTRUCTIONS

The mower as received from the factory is virtually completely assembled and requires minimum time to complete assembly and is ready for sale.



On a fully assembled unit, do not release the Wing Lock Pin until the hoses are attached to the tractor and the Wing Cylinders are filled with oil. Always keep bystanders away while raising and lowering the wings.

To lower the wings, hook the hydraulic hoses to the tractor. From the Operators Seat use the tractor hydraulic control levers to fill wing cylinders with oil (Refer to Operation Section). Keep coworkers and bystanders away from the implement while filling. For implements with the wings in the raised or transport position, filling the cylinders should raise the wings slightly and loosen the wing lock pin. DO NOT release the wing lock pin if there is a force on the lock. Use tractor hydraulic control levers to lower the wing(s). Continue to hold the control lever until both wings are down and the wing cylinders are fully retracted or extended. Continue to cycle the cylinders several times by raising and lowering the wings fully to remove any trapped air. If there is sponginess during the raising cycle, this may indicate that air is entrapped in the hydraulic circuit. Continue to cycle the cylinders until all sponginess is removed.

The implement wings should lower slowly when they are allowed to float down and are not powered down. This is a safety feature built into the system. If the wings fall rapidly, have the cylinders repaired before operating the implement.  
*Asm-0004*



ASSEMBLY

## ASSEMBLY

Select a suitable work area large enough to allow for lowering of the wings. Use extreme caution when connecting the mower to the tractor. The mower should be securely resting at ground level or sitting on blocks. Keep hands and feet from under the mower deck and clear of pinch points between the tractor and mower.

The unit comes with all axles and axle arms attached and tires on the center unit. Wing tires will need to be attached to the wing axle arms and if the unit has dual wheel center axle arms, two tires will be assembled to these axle arms.

# ASSEMBLY

## Tongue

During shipping tongue is tilted back toward unit. Roll tongue down into working position. Pin jackstand to tongue.

## Hose Holder

Attach the Hose Holder to the mounting lug on the inside left strut of the tongue. Use the 5/8" x 2" bolt, 5/8" nut and flatwasher provided.

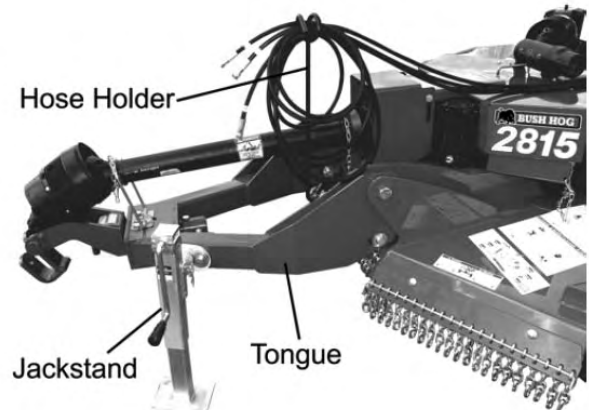

## LINKAGE RODS

Pin the leveling rods assemblies to the tongue using pin, flatwasher and cotter pins shipped with assembly. The slotted casting end should be attached to the tongue (Position for greasing). It may be necessary to raise the tongue slightly for the attachment of the leveling rod. Connect the opposite end to the center-axle weldment using the pin and cotter pins shipped in the leveling rod assembly.

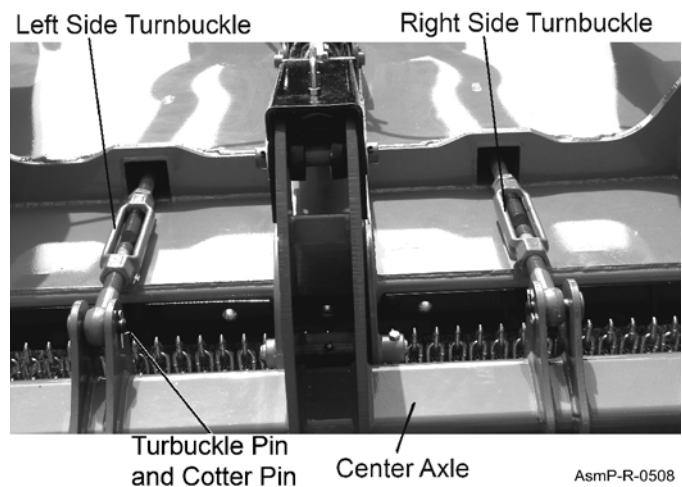
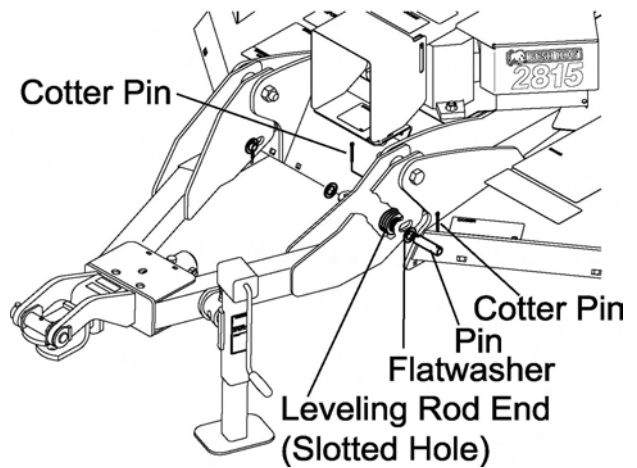

AsmP-R-0508

# ASSEMBLY

ASSEMBLY

## TIRES AND WHEELS

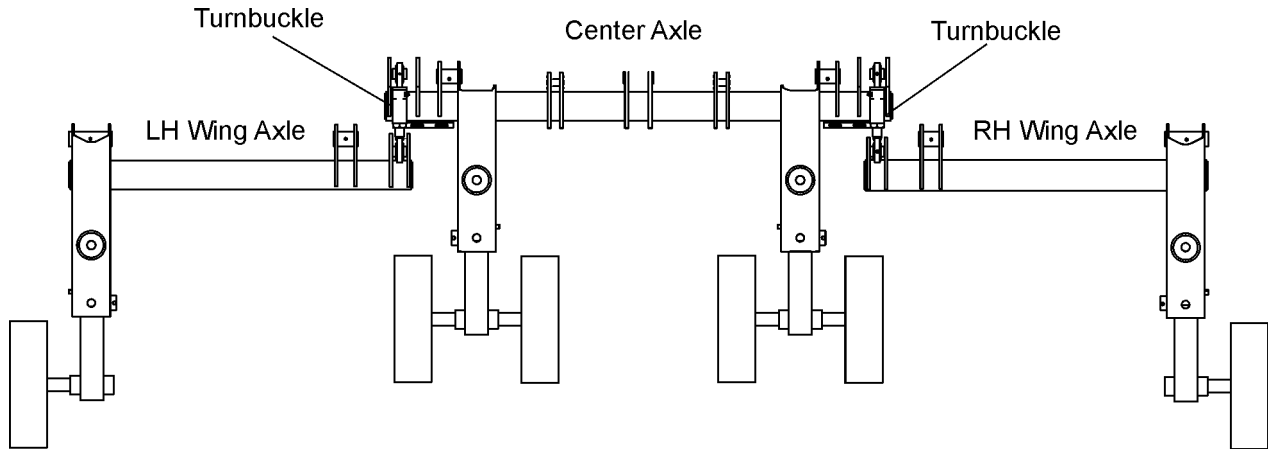

1. Mount wheels on hubs securing with lug nuts. **NOTE: When using laminated tires and airplane tires, the flat side of the lug nut should be against the rim. When using automotive rims, the tapered side of the lug nut should be against the rim.**
2. Attach turnbuckles adjustment links to the center axle mounts using 1" x 5-1/2" bolts and wing axle mounts using 1"x 4" bolts, flatwashers, and nuts **AsmP-R-0509**.
3. There are two types of wheels available for this machine. The airplane tires will have a larger diameter than the laminated tire. Pin the base end of the cylinder according to the type of tire being used.

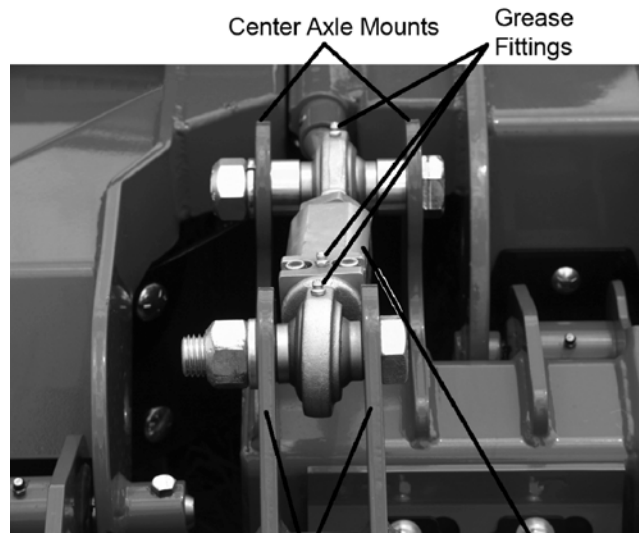

AsmP-R-0509

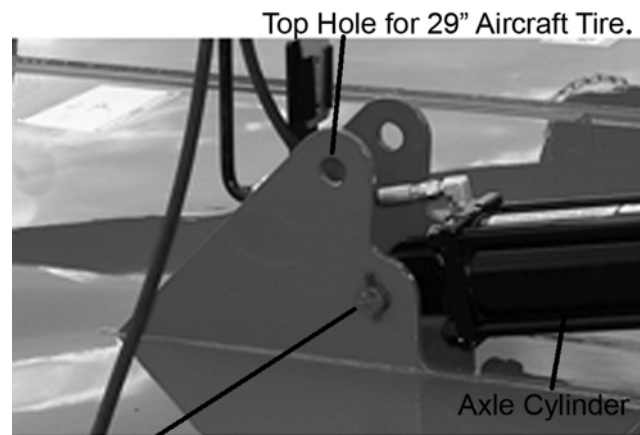

AsmP-R-0510

# ASSEMBLY

Before installing any tires and wheels make certain the Cutter is jacked up high enough and is securely supported. When installing laminated or airplane tires, be sure the flat side of the lug nut is against the wheel. There are only three types of tires that can be used on this cutter DO NOT USE ANY OTHER TYPE OF TIRE OR WHEEL, such as automotive tires and rims. DO NOT EXCEED THE MAXIMUM SPEED FOR EACH TYPE OF TIRE. As excessive speed can cause damage to the machine, tire, and wheel.

When installing Laminated Tires and Wheels note the direction of travel and the curvature of rubber segments in the tire and install as shown in **Figure Asm-R-0127**. Do not exceed 20 M.P.H. on Laminated Tires. When removing Airplane Tires, let all of the air out of the tire before removing lug nuts or wheel bolts or nuts. Remove valve core to make certain that there is no air pressure left in tube before separating wheel halves to dismount tires. DO NOT LOOSEN WHEEL CLAMP BOLTS BEFORE PRESSURE IS REMOVED FROM TUBE AND TIRE TO PREVENT EXPLOSIVE SEPARATION OF WHEEL HALVES WITH POSSIBLE SERIOUS BODILY INJURY. Do not exceed 20 M.P.H. on Airplane or Rib Implement Tires.

Maximum airplane tire inflation pressure is 50 PSI, minimum inflation pressure is 20 PSI. Inflate ribbed implement tires to manufacturer rated PSI as shown on the tire sidewall.

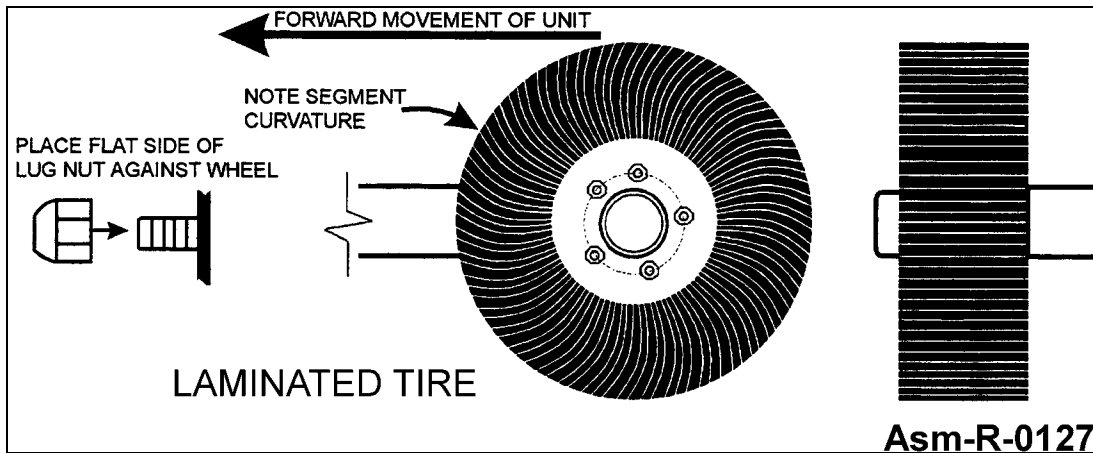

# ASSEMBLY

Asm-R-0213

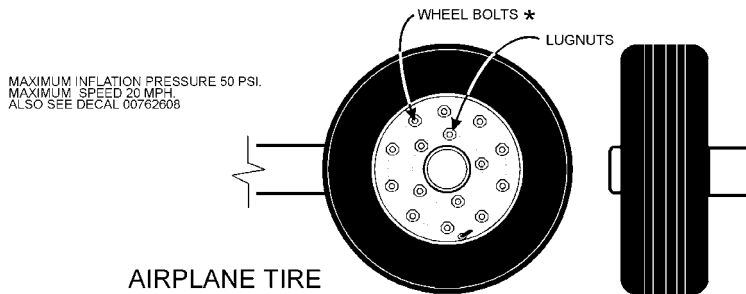
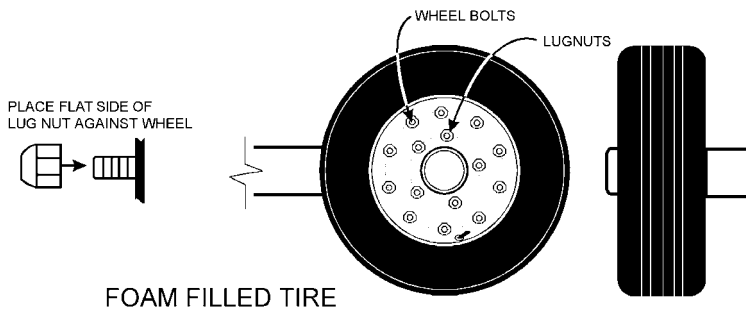
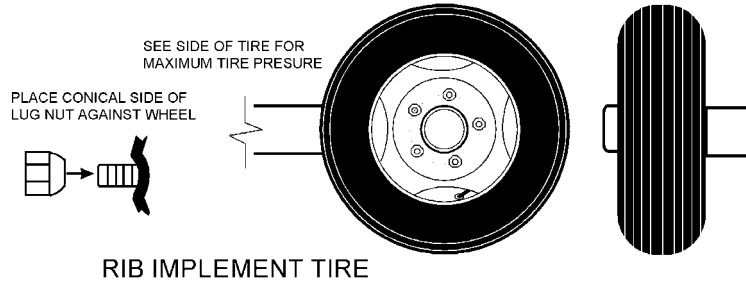

## WARNING

## EXPLOSION HAZARD

**RELEASE ALL AIR PRESSURE BEFORE LOOSENING BOLTS.  
FAILURE TO DO SO COULD RESULT IN SERIOUS INJURY OR DEATH  
MAX. SPEED: 20 MPH, MAX. WEIGHT: 4000 LBS., MAX. AIR PRESSURE: 40PSI**

1006348

Lubricate the PTO drivelines and wheel hubs according to the lubrication information found in the Maintenance Section.

\* Before loosening the airplane wheel bolts, make sure to relieve all air pressure from tire.

# ASSEMBLY

## HYDRAULICS

Plumb hydraulic cylinders as shown. Figure Asm-R-0600 and Asm-R-0601 (Hydraulic Hoses are supplied for attachment to three tractor remotes.) Plugs are supplied to adapt valve for either an open or closed center tractor hydraulic system. Consult your tractor dealer to determine which type system your tractor has. Use tie straps to secure hydraulic hoses to leveling rod.

### Important

Failure to match valve to tractor hydraulic system by using incorrect plug will cause damage to tractor.

## OPTIONAL VALVE MOUNTING BRACKET INSTALLATION

1. Place bottom bracket at desired mounting location. Mark 2 - 4 hours (as needed) for drilling using bracket as pattern. Drill holes using 13/32 drill bit.
2. Mount lower bracket using four 3/8" x 1-1/2" bolts, nuts, flatwashers, and lockwashers.
3. Attach valve to top bracket using three 3/8" x 2-1/2" bolts, nuts and lockwashers.
4. Mount top bracket to bottom bracket using quarter turn fasteners. Insert quarter turn fastener into clip-on receptacle and turn 90 degrees. **Ops-1451**

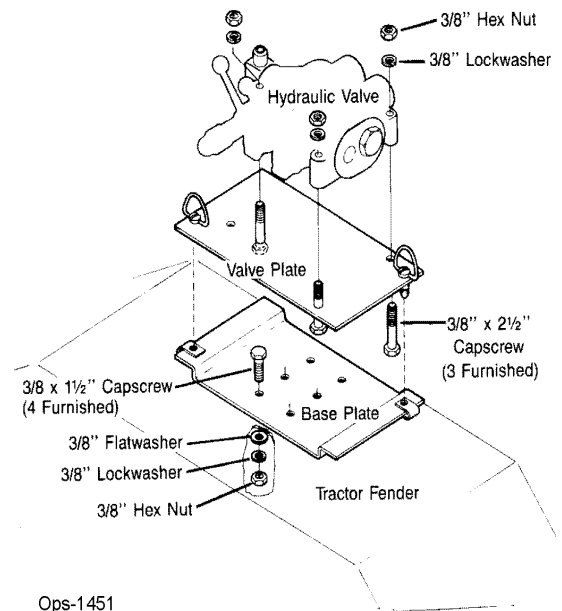

# ASSEMBLY

## 2815-2 / 12815-2 PLUMBING

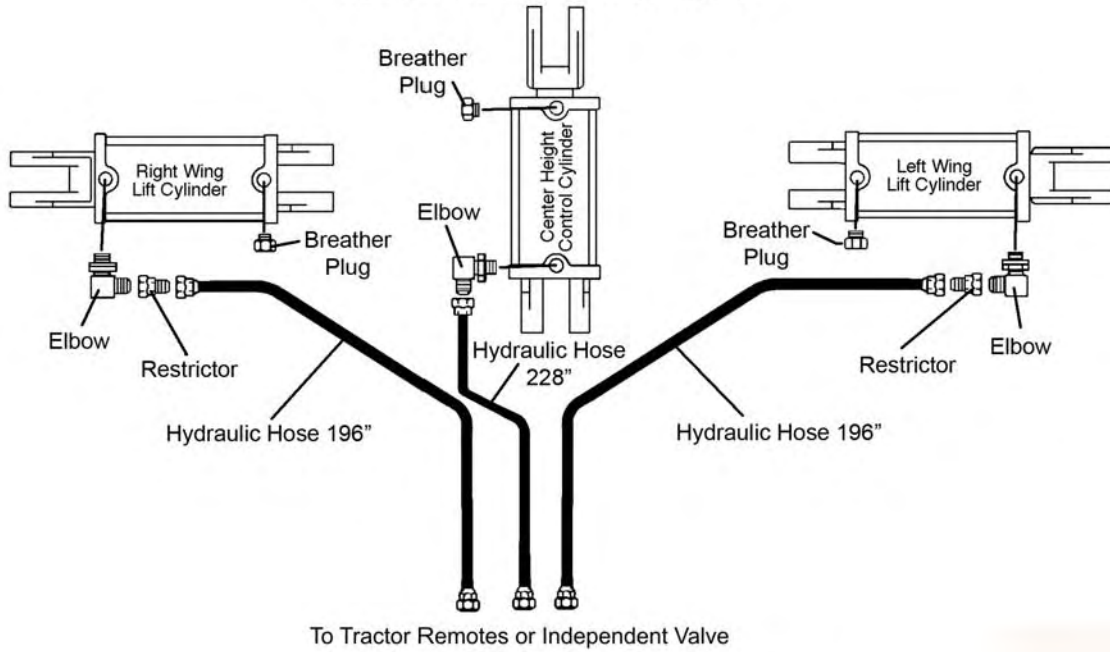

## 2810-2 / 12810-2 PLUMBING

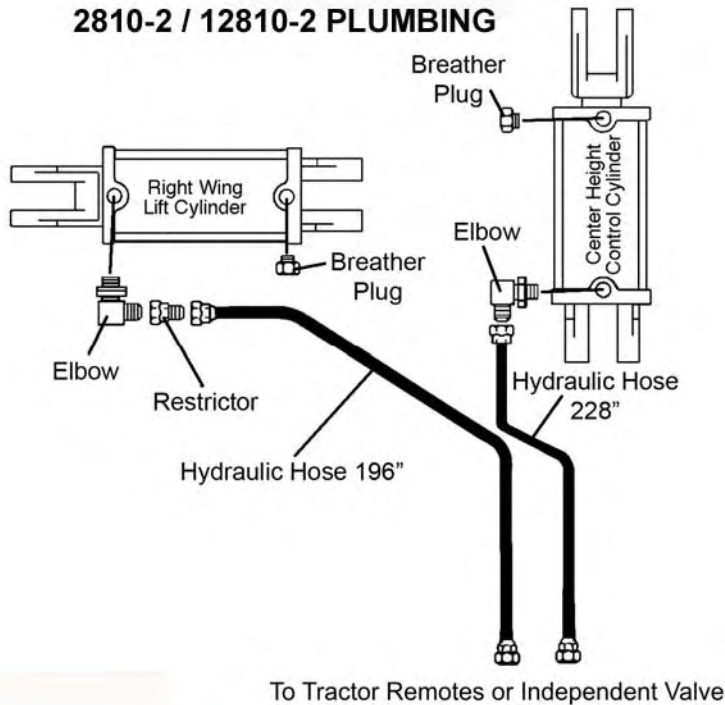

All versions of the 2815/2810 are shipped from the factory with the plumbing attached. Be sure to check fittings prior to use, to make sure they are tight. Fittings for attaching to the tractor remotes or independent valves should be purchased locally to fit the application.



# ASSEMBLY

## DRIVELINE ATTACHMENT TO IMPLEMENT

### CV DRIVELINE

1. Secure the opposite end to the power divider gearbox using the tapered pin and locknut. Tighten nut to 30 ft. lbs.
2. Install driveline with the CV body attaching to the tractor PTO.
3. Pull on each driveline section to make certain it is securely attached.
4. Do not chain the CVF bell shielding. Attach all driveline shield chains to keep shields from turning.

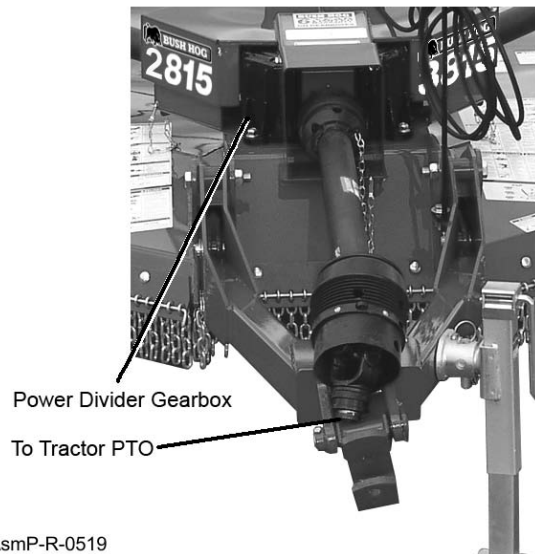

AsmP-R-0519

ASSEMBLY

### CENTER DRIVELINE

**NOTE:** The center driveline is assembled too the unit at the factory and these instructions are for reinstallation, should it be removed for repair. Follow reverse order for driveline removal.

1. Assemble center section driveline as shown in Asm-R-0602. The driveline must be disassembled by removing the bolts holding the two halves together. Install clutch end to center section gearbox using tapered pin, lockwasher, and nut. **Tighten to 30 ft. lbs.** Slide yoke end onto power divider gearbox. Reinstall bolts holding the two halves together. Note that the bolts must be installed so that nuts will be on clutch end. Rotate grease fittings to the top for easy access later.

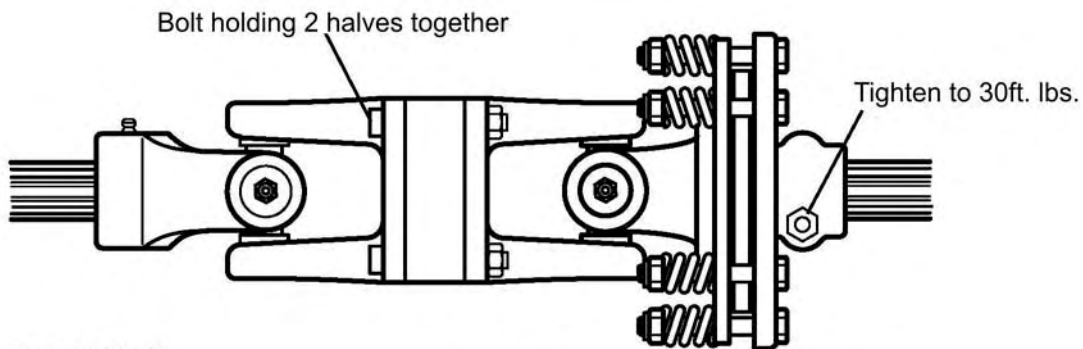

Asm-R-0602

Clutch End to Center Section Gearbox

# ASSEMBLY

## WING DRIVELINE

**NOTE:** The Wing driveline is assembled too the unit at the factory and these instructions are for reinstallation, should it be removed for repair. Follow reverse order for driveline removal.

1. Install wing drivelines, attaching clutch to wing gearboxes. Secure driveline with tapered pin, lockwasher, and nut. Tighten nut to 30 ft. lbs. Pull on each driveline section to make certain it is securely attached.
2. Attach all driveline shield chains to keep shields from turning. **Figures AsmP-R-0520 and AsmP-R-0512**
3. On each clutch, loosen eight nuts retaining clutch springs 1/3 turn or until spring can be turned with fingers.
4. With tractor at idle speed, engage tractor PTO drive 2 - 3 seconds. Each clutch should slip without turning blades.
5. Retighten nuts to within 1/64" or original position. Initial spring length for the clutches is 1.27".

**Important**

Failure to retighten nuts to original position may cause damage to implement and/or tractor due to improper slip clutch torque setting.

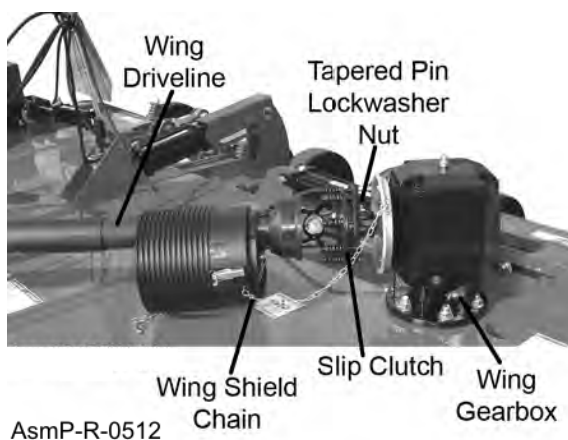
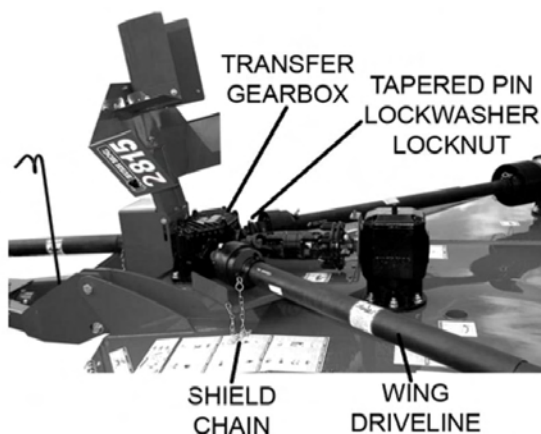

AsmP-R-0512

## DRIVELINE ATTACHMENT

The driveline yoke and tractor PTO shaft must be dirt free and greased for attachment.

To connect the mower driveline to the tractor PTO output shaft, pull the driveline yoke collar back and align the grooves and splines of the yoke with those of the PTO shaft. Push the driveline yoke onto the PTO shaft, release the locking collar, and position the yoke until the locking collar balls are seated onto the PTO shaft. Push and pull the driveline back and forth several times to ensure a secure attachment. OPS-R-0003\_1



**CAUTION**

Many of the equipment components are **HEAVY** (60 lbs or greater) and Special Lifting Procedures are recommended. Use lifting assistance such as mechanical assistance, two people, and proper lifting techniques when connecting or installing the driveshaft to reduce the possibility of back injuries.

# OPERATION SECTION

Operation Section 4-1

# OPERATION

## BUSH HOG 2815-2/2810-2/12815-2/12810-2 ROTARY MOWER OPERATION INSTRUCTIONS

Bush Hog rotary mowers are manufactured with quality material by skilled workers. These mowers are designed to cut grass, weeds, small brush and other vegetative material up to 4" diameter in areas such as pastures and along highway right-of-ways. The mower is equipped with protective deflectors and/or chain guards to prevent objects being thrown from the mower by the blades, however, no shielding is 100% effective. All shields, guards, deflectors, and chains equipped on the unit must be maintained on the mower in good operational condition.

It is the operator's responsibility to be knowledgeable of all potential operating hazards and to take every reasonable precaution to ensure oneself, others, animals, and property are not injured or damaged by the mower, tractor, or a thrown object. Do not operate the mower if passersby, pets, livestock, or property are within 300 feet of the unit unless:

- **ALL THROWN OBJECT SHIELDING** including, Front and Rear Deflectors, Chains Guards, Steel Guards, Bands, Side Skirts and Skid Shoes in place and in good condition when mowing.
- Mower sections or wing are adjusted to be close and parallel to ground without exposing blades.
- **MOWING AREA** has been inspected and foreign materials and debris have been removed.
- **PASSERSBY** are inside enclosed vehicle.

This section of the Operator's Manual is designed to familiarize, instruct, and educate safe and proper mower use to the operator. Pictures contained in this section are intended to be used as a visual aid to assist in explaining the operation of a rotary mower. Some pictures may show shields removed for purposes of clarity. NEVER OPERATE this implement without all shields in place and in good operational condition. The operator must be familiar with the mower and tractor operation and all associated safety practices before operating the mower and tractor. Proper operation of the mower, as detailed in this manual, will help ensure years of safe and satisfactory use of the mower

**IMPORTANT:** To avoid mower damage, retorque all bolts after the first 10 hours of operation. Retighten blade carrier retaining nut on gearbox lower shafts to 600 ft. lbs..

**READ AND UNDERSTAND THE ENTIRE OPERATING INSTRUCTIONS AND SAFETY SECTION OF THIS MANUAL AND THE TRACTOR MANUAL BEFORE ATTEMPTING TO USE THE TRACTOR AND IMPLEMENT.** If you do not understand any of the instructions, contact your nearest authorized dealer for a full explanation. Pay close attention to all safety signs and safety messages contained in this manual and those affixed to the implement and tractor. *OPS-U- 0001*

READ, UNDERSTAND, and FOLLOW the following Safety Messages. Serious injury or death may occur unless care is taken to follow the warnings and instructions stated in the Safety Messages. Always use good common sense to avoid hazards. (SG-2)



Si no lee ingles, pida ayuda a alguien que si lo lea para que le traduzca las medidas de seguridad. (SG-3)



¡ LEA EL INSTRUCTIVO!



# OPERATION

## 1. OPERATOR REQUIREMENTS

Safe operation of the unit is the responsibility of a qualified operator. A qualified operator has read and understands the implement and tractor Operator's Manuals and is experienced in implement and tractor operation and all associated safety practices. In addition to the safety messages contained in this manual, safety signs are affixed to the implement and tractor. If any part of the operation and safe use of this equipment is not completely understood, consult an authorized dealer for a complete explanation.

If the operator cannot read the manuals for themselves or does not completely understand the operation of the equipment, it is the responsibility of the supervisor to read and explain the manuals, safety practices, and operating instructions to the operator.

Safe operation of equipment requires that the operator wear approved Personal Protective Equipment (PPE) for the job conditions when attaching, operating, servicing, and repairing the equipment. PPE is designed to provide operator protection and includes the following safety wear:

### **PERSONAL PROTECTIVE EQUIPMENT (PPE)**

- Always Wear Safety Glasses
- Hard Hat
- Steel Toe Safety Footwear
- Gloves
- Hearing Protection
- Close Fitting Clothing
- Respirator or Filter Mask (depends on operating conditions) *OPS-U- 0002*

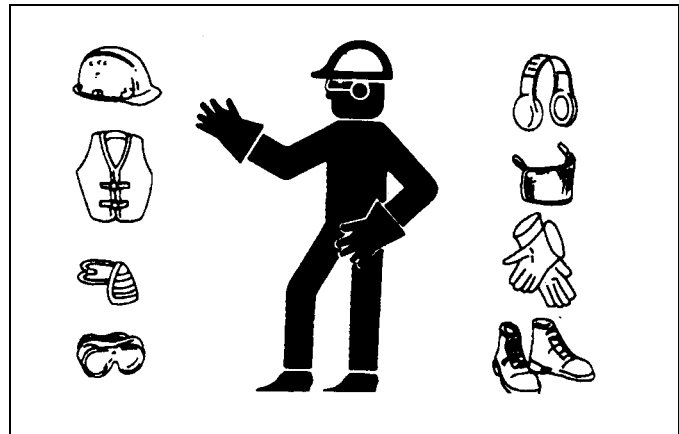

### **⚠ DANGER**

DO NOT use drugs or alcohol immediately before or while operating the Tractor and Implement. Drugs and alcohol will affect an operator's alertness and coordination and therefore affect the operator's ability to operate the equipment safely. Before operating the Tractor or Implement, an operator on prescription or over-the-counter medication must consult a medical professional regarding any side effects of the medication that would hinder their ability to operate the Equipment safely. NEVER knowingly allow anyone to operate this equipment when their alertness or coordination is impaired. Serious injury or death to the operator or others could result if the operator is under the influence of drugs or alcohol. (SG-27)

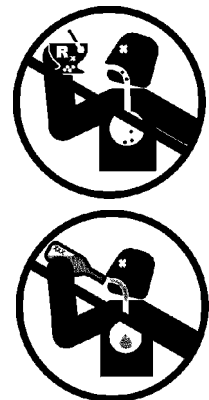

# OPERATION

## 2. TRACTOR REQUIREMENTS

The tractor used to operate the mower must have the power capacity to lift, pull, and operate the Power Take Off (PTO) at the mower's rated speed while traveling at a ground speed between 2 and 5 MPH. Operating the mower with a tractor that does not meet the following requirements may cause tractor or mower damage and be a potential danger to the operator and passersby.

### **Tractor Requirements and Capabilities**

- ASABE approved Roll-Over Protective Structure (ROPS) or CAB and seat belt.
- Tractor Safety Devices ..... Slow Moving Vehicle (SMV) emblem, lighting, PTO master shield
- Tractor Horsepower -Minimum ..... 60 HP
- -Maximum ..... 120 HP
- Drawbar ..... 14" length for 540 unit; 16" or 20" length for 1000 RPM unit.
- Drawbar Vertical Load Minimum ..... 2108 lbs.
- Hydraulics ..... 3 Hydraulic Ports are required - Without Remote Valve  
2 Hydraulic Ports are required - With Remote Valve
- Front End Weights ..... As needed to maintain 20% weight on front axle
- Power Take Off ..... 540 RPM 6-Spline, 1000 RPM 21-Spline or  
1000 RPM -1-3/4" dia. 20-Spline Output Shaft
- Tire Wheel Spacing ..... Set tires minimum width of 60" from inside to inside of tires.

### 2.1 ROPS and Seat Belt

The tractor must be equipped with a Roll-Over-Protective-Structure (ROPS) (tractor cab or roll-bar) and seat belt to protect the operator from falling off the tractor, especially during a roll over where the driver could be crushed and killed. Only operate the tractor with the ROPS in the raised position and seat belt fastened. Tractor models not equipped with a ROPS and seat belt should have these life saving features installed by an authorized dealer. *OPS-U- 0003*



Operate this Equipment only with a Tractor equipped with an approved roll-over-protective system (ROPS). Always wear seat belts. Serious injury or even death could result from falling off the tractor--particularly during a turnover when the operator could be pinned under the ROPS. (SG-7)



### 2.2 Tractor Safety Devices

If transporting or operating the tractor and implement near a public roadway, the tractor must be equipped with proper warning lighting and a Slow Moving Vehicle (SMV) emblem which are clearly visible from the rear of the unit. Lights and a SMV emblem must be equipped directly on implements if the visibility of the tractor warning signals are obscured.

Maintain all manufacturer equipped safety shields and guards. Always replace shields and guards that were removed for access to connect, service, or repair the tractor or implement. Never operate the tractor PTO with the PTO master shield missing or in the raised position. *OPS-U- 0004*

# OPERATION

## 3. Tractor Horsepower

The horsepower required to operate the mower depends on several operating factors including the vegetation to be cut, terrain condition, operator experience, condition of the mower and tractor, and others. For most mowing conditions, the 2815/2810 mower requires a tractor with a minimum of 60 HP. Operating the mower with a tractor that does not have adequate power may damage the tractor engine. Exceeding 120 HP may cause mower damage by overpowering the unit in heavy cutting conditions.

### 3.1 Drawbar

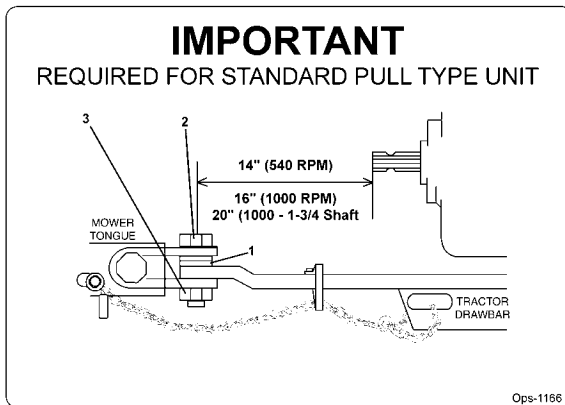

#### **Constant Velocity and Standard Driveline.**

Position the length of the drawbar from the end of the tractor PTO shaft to the drawbar hitch hole according to the operating speed of the mower. If the mower is a 540 RPM unit, position the drawbar length from shaft end to hitch hole at 14". For 1000 RPM mowers, set the drawbar length at 16" for 21 spline 1-3/8" mowers and at 20" for 1-3/4" 20 spline mowers. Do not use PTO adaptors. Use of PTO adaptors will invalidate your warranty.

### 3.2 Tractor Hydraulics

The mower center section and each wing are positioned with hydraulic cylinders that are operated by the tractor hydraulic pump. The tractor must have a minimum of 2 hydraulic control valves devoted to the mower unless the tractor is fitted with a 3-spool control valve (extra equipment).

A 3-spool control valve is required if the tractor is equipped with a single valve and is recommended for those with two valves so that the center section and each wing can be controlled independent of one another. Refer to the Assembly Section of this manual for properly equipping the tractor with a 3-spool control valve. Tractors equipped with three hydraulic ports can position the center section and each wing independently with no extra equipment. If the tractor is equipped with only two hydraulic ports and a 3-spool control valve is not used, the wings cannot be operated independently and will raise and lower at different speeds.

### 3.3 Front End Weight

A minimum of 20% total tractor weight must be maintained on the tractor front end at all times. Front end weight is critical to maintain steering control and to prevent the tractor from rearing up while driving. If the front end is too light, add weight until a minimum of 20% total weight is reached on the front tires. Front weights and weight carriers can be purchased through an authorized tractor dealership. OPS-U- 0005

# OPERATION

## 3.4 Power Take Off (PTO)

Depending on the unit, the mower is designed to operate at a PTO speed of 540 or 1000 RPM. Most tractors operate at either 540, or a combination of 540 and 1000 RPM PTO speeds. The operating speed of the mower and tractor can be determined by the number of splines on the driveline yoke and PTO output shaft. Those operating at 540 RPM will have a 6-spline shaft and those operating at 1000 RPM will have a 20 or 21-spline shaft. **Note:** Refer to the tractor owner's manual for instructions to change PTO speeds on models that operate at more than one speed.

If operating an older model tractor where the tractor's transmission and PTO utilize one master clutch, an over-running clutch must be used between the PTO output shaft and the driveline of the mower. An authorized tractor dealer can provide the over-running clutch and its installation if needed. OPS-U- 0006\_A



**DO NOT** use a PTO adapter to attach a non-matching Implement driveline to a Tractor PTO. Use of an adapter can double the operating speed of the Implement resulting in excessive vibration, thrown objects, and blade and implement failure. Adapter use will also change the working length of the driveline exposing unshielded driveline areas. Serious bodily injury and/or equipment failure can result from using a PTO adapter. Consult an authorized dealer for assistance if the Implement driveline does not match the Tractor PTO.

(S3PT-14)



Never operate the Tractor and Mower if the Implement input driveline is directly connected to the Tractor transmission. Tractor braking distances can be substantially increased by the momentum of the rotating Mower blades driving the Tractor transmission even though the Tractor clutch has been disengaged. Install an over running clutch between the Tractor PTO and the Mower driveline to prevent this potentially dangerous situation. (S3PT-16)



Do not connect the PTO driveline to the tractor or operate the implement unless the implement is securely connected to the tractor.

## 3.5 Tire Spacing

Tractor tires should be set a minimum of 60" (1.5 mm) apart measured from inside of tire to inside of tire. Refer to the tractor Operator's Manual or consult an authorized dealer for instructions to change tractor tire spacing. OPS-R- 0062





# OPERATION

## 4. GETTING ON AND OFF THE TRACTOR

Before getting onto the tractor, the operator must read and completely understand the implement and tractor operator manuals. If any part of either manual is not completely understood, consult an authorized dealer for a complete explanation. *OPS-U- 0007*



**WARNING**

Do not mount or dismount the Tractor while the tractor is moving. Mount the Tractor only when the Tractor and all moving parts are completely stopped. (SG-12)



### 4.1 Boarding the Tractor

Use both hands and equipped handrails and steps for support when boarding the tractor. Never use control levers for support when mounting the tractor. Seat yourself in the operator's seat and secure the seat belt around you.

Never allow passengers to ride on the tractor or attached equipment. Riders can easily fall off and be seriously injured or killed from falling off and being ran over. It is the operator's responsibility to forbid all extra riders at all times. *OPS-U- 0008*



**DANGER**

Never allow children to operate, ride on, or come close to the Tractor or Implement. Usually, 16-17 year-old children who are mature and responsible can operate the implement with adult supervision, if they have read and understand the Operator's Manuals, been trained in proper operation of the tractor and Implement, and are physically large enough to reach and operate the controls easily. (SG-11)



**DANGER**

Never allow children or other persons to ride on the Tractor or Implement. Falling off can result in serious injury or death. (SG-10)



### 4.2 Dismounting the Tractor

Before dismounting, park the tractor and implement on a reasonably level surface, apply the parking brake, idle the engine down, disengage the PTO, and lower the implement to the ground. Shut down the tractor engine according to the operator's manual, remove the key, and wait for all motion to completely stop. Never leave the seat until the tractor, its engine and all moving parts have come to a complete stop.

Use hand rails and steps when exiting the tractor. Be careful of your step and use extra caution when mud, ice, snow or other matter has accumulated on the steps or hand rails. Use all handrails and steps for support and never rush or jump off the tractor. *OPS-U- 0009*

# OPERATION

## **▲ DANGER**

BEFORE leaving the tractor seat lower the implement, set the parking brake and/or set the tractor transmission in parking gear, disengage the PTO, stop the engine, remove the key, and wait for all moving parts to stop. Place the tractor shift lever into a low range or parking gear to prevent the tractor from rolling. Never dismount a Tractor that is moving or while the engine is running. Operate the Tractor controls from the tractor seat only. (SG-9)

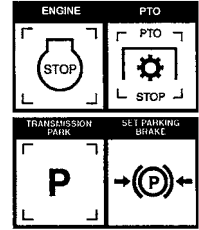

## **5. STARTING THE TRACTOR**

The operator must have a complete understanding of the placement, function, and operational use of all tractor controls before starting the tractor. Review the tractor operator's manual and consult an authorized dealer for tractor operation instructions if needed.

### **Essential Tractor Controls:**

- Locate the light control switch.
- Locate the engine shut off control.
- Locate the brake pedals and the clutch.
- Locate the PTO control.
- Locate the 3-point hitch control lever.
- Locate the hydraulic remote control levers.

### **Before starting the tractor ensure the following:**

- Conduct all pre-start operation inspection and service according to the tractor operator's manual.
- Make sure all guards, shields, and other safety devices are securely in place.
- The parking brake is on.
- The PTO control lever is disengaged.
- The 3-point hitch control lever is in the lowered position.
- The hydraulic remote control levers are in the neutral position.
- The tractor transmission levers are in park or neutral.

Refer to the tractor owner's manual for tractor starting procedures. Only start the tractor while seated and belted in the tractor operator's seat. Never bypass the ignition switch by short circuiting the starter solenoid.

After the tractor engine is running, avoid accidental contact with the tractor transmission to prevent sudden and unexpected tractor movement. OPS-U-0028

## **▲ DANGER**

Never run the Tractor engine in a closed building or without adequate ventilation. The exhaust fumes can be hazardous to your health. (SG-23)

## **▲ DANGER**

Start tractor only when properly seated in the Tractor seat. Starting a tractor in gear can result in injury or death. Read the Tractor operators manual for proper starting instructions. (SG-13)



# OPERATION<sub>2</sub>

## 6. CONNECTING THE MOWER TO THE TRACTOR

Use extreme caution when connecting the mower to the tractor. The mower should be securely resting at ground level or setting on blocks. Keep hands and feet from under the mower deck and clear of pinch points between the tractor hitch arms and mower pins. *OPS-R-0001*

**⚠ DANGER**

Always shut the Tractor completely down, place the transmission in park, and set the parking brake before you or anyone else attempts to connect or disconnect the Implement and Tractor hitches. (S3PT-15)

### 6.1 Connecting Mower Tongue to the Tractor

1. Ensure the tractor is equipped with the correct PTO shaft and the drawbar is set at the correct length.
2. Using the parking jack, position the tongue clevis to the height of the tractor drawbar. Adjust the mower tongue to be level and parallel with the tractor drawbar using the control rod connecting the mower tongue to the deck.
3. Board the tractor and start the engine. Back the tractor to the mower aligning the drawbar hitch hole with the mower tongue clevis. Turn off the tractor engine, place the tractor in park, and set the parking brake before dismounting.

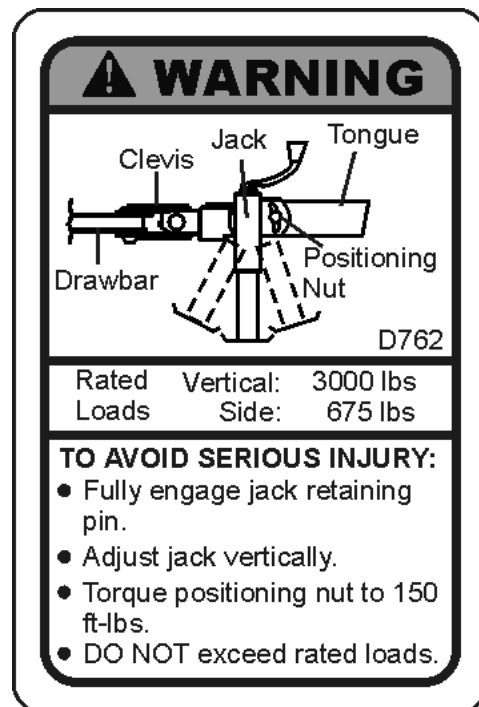

# OPERATION

- To attach the mower, place two 1" flatwashers (1) positioned under top lip of tongue clevis and to the top of drawbar. Insert a 1" diameter grade 5 or 8 bolt (3) through clevis and drawbar and retain in position with a 1" locknut (4). Tighten the locknut securely but do not overtighten which could spring or break the clevis. NEVER attach mower to the tractor with a pin not having a nut.
- Securely attach the mower safety chain to the tractor drawbar or drawbar support frame.
- Lower the jack until the tongue is completely supported by the drawbar. Remove jack from the tongue and place on storage bracket of mower.

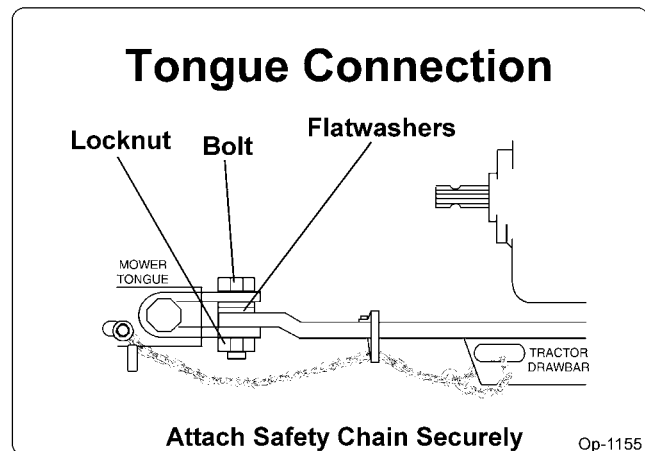

## Safety Tow Chain

If the mower is towed on a public roadway, a safety chain with tensile strength equal to or greater than the gross weight of the mower must be connected between the tractor and mower. This will help control the implement in the event the tongue becomes disconnected from the drawbar. Make sure the chain is attached to a secure location on the tractor and not to an intermediate support. After connecting both ends of the safety chain, drive the tractor to the right and left to check for proper chain length. Adjust length as necessary and allow only enough slack in the chain to make a maximum turn in both directions. Use chain intermediate support on tractor drawbar to minimize chain slack. When not in use, store the safety chain to protect it from mud or standing water by wrapping the chain around the tongue. Replace the safety chain if one or more links or end fittings are broken, stretched or otherwise damaged or deformed.

IMPORTANT: Scan this QR Code with your smart phone to link to the PAMI Safe Implement Hitching Manual for more information on correctly connecting agricultural tractors to implements. Or type in your internet browser the following web address: [www.algqr.com/hme](http://www.algqr.com/hme) Ops-0008-MISC



## 6.2 Connecting Mower Hydraulic Lines to the Tractor

With the tractor shut down and secured in position, relieve hydraulic pressure from the tractor by moving the control levers back and forth several times or placing the levers in the float position.

When connecting the mower hydraulic lines, keep hoses, quick couplers, and swivels free of contamination. Never leave a disconnected hose end open and cap the tractor hydraulic outlet ports when not in use. If the tractor ports or mower hydraulic hose ends become contaminated, wipe clean with a rag before connecting.

### Operating Mower Hydraulics with Three Tractor Hydraulic Ports

Connect one hose into each hydraulic port. Connect lines to correspond with position of hydraulic control levers.

# OPERATION

## Operating Mower Hydraulics with Two Tractor Hydraulic Ports

The lines that operate the wings must be plumbed together and will be controlled using one hydraulic control valve and the center section with the remaining control valve. Ensure that the operator is aware that each wing cannot be controlled independently nor will they raise and lower simultaneously.

## Operating the Mower Hydraulics with a 3-Spool Hydraulic Control Valve (Extra Equipment)

Ensure the valve matches the hydraulic operating system of the tractor (open or closed center). Refer to the Assembly Section for additional information on equipping the tractor with a 3-spool control valve.

Mount the valve bank to a tractor fender or other accessible location. Connect valve bank inlet and outlet lines to outlets of the same tractor hydraulic port. Connect the mower hydraulics to the control valve bank with the center section line to the right port. Connect the wing cylinder lines to the control valve positioned to correspond with the left and right wing.

To activate the 3-spool hydraulic control valve, tie the tractor's hydraulic control lever back to keep hydraulic oil continuously fed to the valve bank.

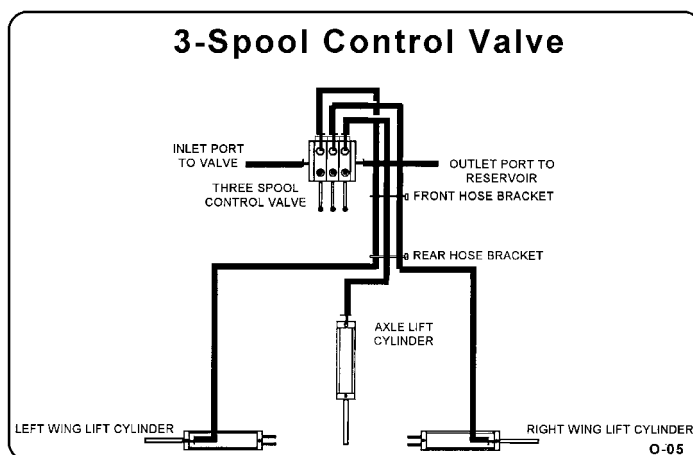

## Hydraulic Line Support

After connecting the mower hydraulic lines to the tractor, support the hoses with the equipped brackets. Ensure that hoses do not contact the driveline, do not bind while turning, and do not become pinched or kinked.

## Hydraulic Cylinder Priming

Hydraulic Cylinders must be filled with hydraulic oil before removing the wing transport lock pins to lower the mower wings. Hydraulic cylinders and lines are filled by holding the valve control levers in the raised position until the cylinders fully retract (wing cylinders) and extend (center cylinder). Place control levers in the float position and repeat process a second time. Ensure wings are entirely supported by the cylinders before removing the transport lock pins. NEVER drive out bar pins and NEVER remove bars that have tension on them.

# OPERATION

## 7. SETTING THE MOWER

Properly setting the cutting height is essential for efficient and safe operation. A properly set mower will make a more uniform cut, distribute clippings more evenly, require minimal tractor work, and follow the contour of uneven terrain. **NOTE:** Avoid very low cutting heights, striking the ground with the blades gives the most damaging shock loads and will cause damage to the mower and drive. Blades contacting the ground may cause objects to be thrown out from under the mower deck. Always avoid operating the mower at a height which causes the blades to contact the ground. OPS-U- 0010



Never work under the Implement, the framework, or any lifted component unless the Implement is securely supported or blocked up to prevent sudden or inadvertent falling which could cause serious injury or even death. (SG-14)



### 7.1 Setting Deck Height

#### LEVELING DECK CENTER SECTION

1. Place the tractor and mower on a level surface and lower both wings.
2. Using the center section hydraulic cylinder, raise to transport height and loosen level rod jam nuts. Position the mower so the skid shoes are 1" less off the ground than the final cut height. For example, for a 3" cut raise or lower the mower until the skid shoes are approximately 2" off the ground.
3. Shut down the tractor, place the transmission in park, and set the parking brake before dismounting.
4. Level the mower deck front to rear by adjusting the leveling rods linking the tongue to the rear axle. DO NOT allow feet or other body parts underneath the mower when making adjustments. To adjust rod length turn the turnbuckles. To lower the front, lengthen the rods and to raise the front, shorten the rods DO NOT unscrew turnbuckles to the point that either rod threaded ends becomes disconnected which will cause the mower to fall. Raise to transport height and re-tighten jamnuts when deck is leveled.
5. **IMPORTANT:** Alternate adjustments between rods and adjust at equal lengths to maintain equal tension. Improper adjustments may cause rods to snap or bend.
6. Place split collar assemblies on the center axle hydraulic cylinder rod to maintain a set cutting height each time the mower is raised and lowered.

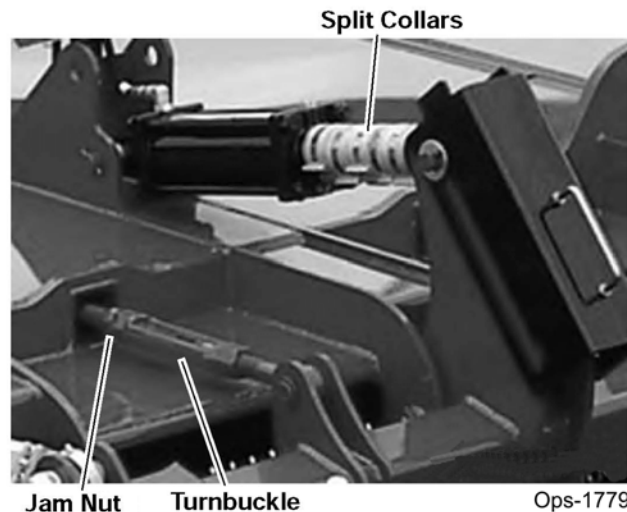

Ops-1779

#### LEVELING WING SECTIONS WITH CENTER

Wings should be adjusted before use if they are not level with center deck section. Lower cutter until skids on center section are approximately 1-2 inches off ground. Remove wing transport lock pin(s) and place in pin storage hole. Lower wing(s) to ground allowing weight to rest on wheel(s). If wing(s) are not level (parallel) to

# OPERATION

center section, loosen jam nut and turn turnbuckle body to adjust. Adjust longer to raise the wing outside edge and shorter to lower the wing outside edge. It may be necessary to use wing lift cylinder to relieve pressure from the linkage retaining pin/ Tighten jam nut.

Lock Pin Storage Transport Location Ops-1780

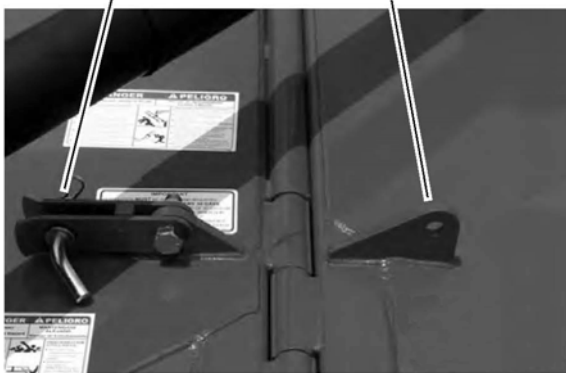

Adjustable Link Ops-1781

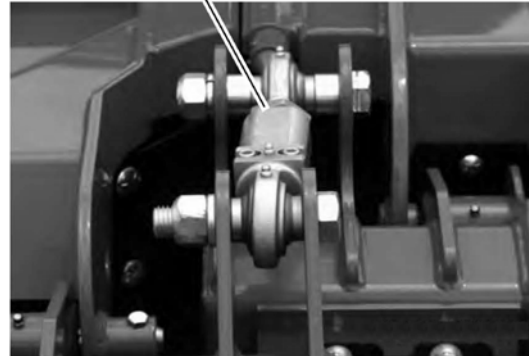

## Setting Deck Pitch

### Lower Horse Power - Better Fuel Efficiency

To increase fuel efficiency and lower horsepower requirements for mower operation, the mower should be operated with the deck approximately 1" or less LOWER IN THE FRONT THAN THE REAR. Operating the mower at this pitch will allow the mower to cut the grass only once and requires less work from the tractor.

### Increase Mulching

To increase mulching of the grass or crop material during mower operation, the mower should be operated with the deck approximately 3/4" HIGHER IN THE FRONT THAN THE REAR.

Operating the mower at this pitch will allow the mower to cut the grass twice and can result in a more even cut and improved distribution of the cut material.

### IMPORTANT:

*Adjust the leveling rods the same amount and maintain equal tension in the rods. Improper adjustment may cause rods to snap or bend. Retighten the jamnuts after the deck pitch has been set. OPS-U-0041\_A*

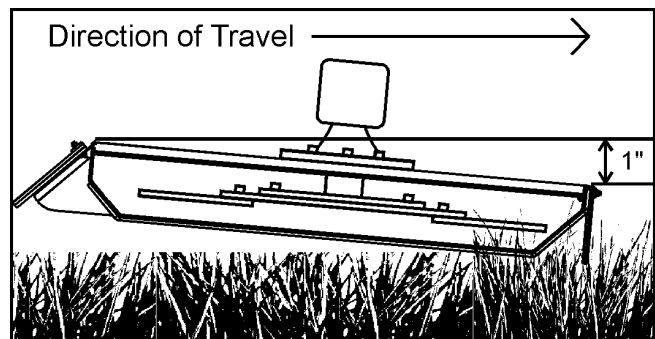

**Better Fuel Efficiency**

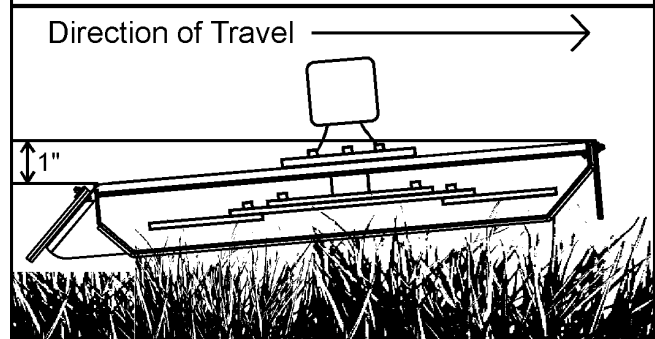

**Increase Mulching**

Ops-1454

# OPERATION

## **8. DRIVELINE ATTACHMENT**

The driveline yoke and tractor PTO shaft must be dirt free and greased for attachment.

To connect the mower driveline to the tractor PTO output shaft, pull the driveline yoke collar back and align the grooves and splines of the yoke with those of the PTO shaft. Push the driveline yoke onto the PTO shaft, release the locking collar, and position the yoke until the locking collar balls are seated onto the PTO shaft. Push and pull the driveline back and forth several times to ensure a secure attachment. OPS-R-0003\_A

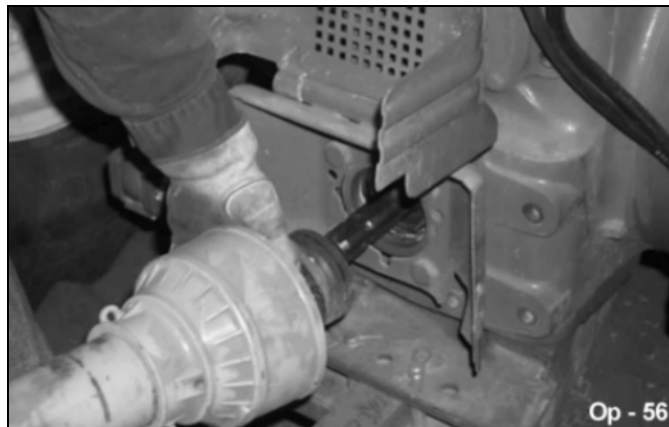

### **▲WARNING**

When attaching the Implement input driveline to the Tractor PTO, it is important that the connecting yoke spring activated locking collar slides freely and the locking balls are seated securely in the groove on the Tractor PTO shaft. Push and pull the driveline back and forth several times to ensure it is securely attached. A driveline not attached correctly to the Tractor PTO shaft could come loose and result in personal injury and damage to the Implement. (S3PT-17)

### **8.1 Driveline Length Check**

#### **▲WARNING**

Before operating the Implement, check to make sure the Implement input driveline will not bottom out or become disengaged. Bottoming out occurs when the inner shaft penetrates the outer housing until the assembly becomes solid-it can shorten no more. Bottoming out can cause serious damage to the Tractor PTO by pushing the PTO into the Tractor and through the support bearings or downward onto the PTO shaft, breaking it off. A broken driveline can cause personal injury. (S3PT-18)

When fitting the mower to the tractor, the telescoping driveline must be inspected to ensure that at its most compressed position, the profiles do not “bottom out”, and when at its farthest extended position, there is sufficient engagement between the profiles to operate safely. At its shortest length, there must be at least a 1” clearance between each profile end and opposite profile universal joint. At its farthest operating extension, a minimum profile engagement of 6” must be maintained for a Constant Velocity (CV) tube type driveline and a minimum engagement of 6” for non-CV solid shaft drivelines.



# OPERATION

## “Bottoming Out” Check Procedure

- Disconnect driveline from the tractor and slide the profiles together until fully compressed.
- Place a mark on the inner shield 1/8” from the end of the outer shield and reattach the driveline to the PTO shaft.
- With the **PTO NOT TURNING**, slowly drive the tractor with mower attached through the sharpest turn possible and watch shaft movement. With the **PTO NOT TURNING**, slowly drive the tractor with the mower attached through the most severe terrain conditions expected and watch shaft movement.
- If the distance between the mark and the outer shield becomes less than 2” at any point there is a potential problem bottoming out the driveline and the driveline should be replaced with shorter driveline. Contact your local dealer or Technical Service for proper directions. OPS-R-0004\_J

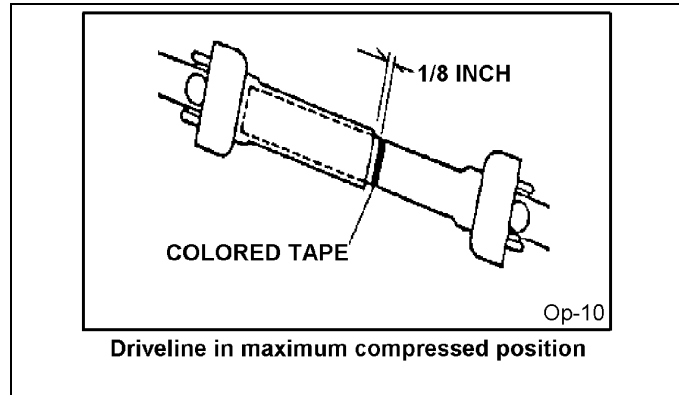

**NOTE:** If tractor has a 540 RPM PTO, adjusting to a 16 inch position will gain additional 2 inches of telescoping length.

## Engagement Check Procedure

- With the driveline attached, position the mower to the point where the telescoping driveline is at its maximum extension. Completely shut down the tractor and secure in position.
- Mark the inner driveline shield 1/8” from the end of the outer shield.
- Disconnect the driveline from the tractor and separate the two driveline halves.
- Measure the distance from the mark to the end of the inner profile. This length is the amount the driveline profiles were engaged.
- If the engaged length is less than 6”, the shaft is considered too short and should be replaced with a longer shaft. Consult an authorized dealer to purchase the required driveline length.

**NOTE:** If the driveline cannot be shortened and still maintain the required profile engagement, the operator must be made aware of terrain conditions and avoid situations which pose a potential problem to avoid damaging the driveline or move drawbar to 16” or 20” position for required clearance. OPS-R-0005\_O

# OPERATION

## 8.2 Constant Velocity (CV) Driveline

For mowers equipped with a Constant Velocity (CV) driveline, the maximum turning angle between the tractor and mower must be determined to ensure the joint angle does not over-extend which can cause CV joint damage. Constant Velocity joints enable the driveline to operate smoothly with no vibrations and clattering at angles up to 80°. Angles greater than 80° can result in mechanical damage to the CV joint and mower driveline.

The Constant Velocity joint must be lubricated every 8 hours of operation as specified in the Maintenance Section. Failure to properly lubricate the joint will result in accelerated wear and joint component failure.

### CV Driveline Maximum Angle Check Procedure

- With the **mower attached** to the tractor and the **driveline disconnected** from the tractor PTO stub make a hard left turn until there is approximately a 1" clearance between the left rear tractor tire and mower frame or tongue.
- Stop and completely shut down the tractor. Place the tractor in Park and apply the Parking Brake before dismounting.
- Check the CV joint at this maximum turning radius by holding the driveline yoke above the PTO shaft and then angle the CV joint to its maximum angle. A minimum difference of 10 degrees between the center line of the yoke and the PTO shaft must be maintained to ensure the joint will not be over angled. If the joint cannot be angled at least 10°, there is a potential problem of over-angling the joint while making sharp turns.

- Solutions: To ensure the joint is not damaged, check the following:

Check the drawbar length to ensure that it is at the proper length for the RPM speed of the mower.

Move the tractor rear tires wider apart to limit the tractor turning radius.

Position the mower at multiple angles and perform the above procedure. Determine the sharpest turning radius that maintains a safe operating angle and note this position to the operator. *OPS-R-0006\_B*

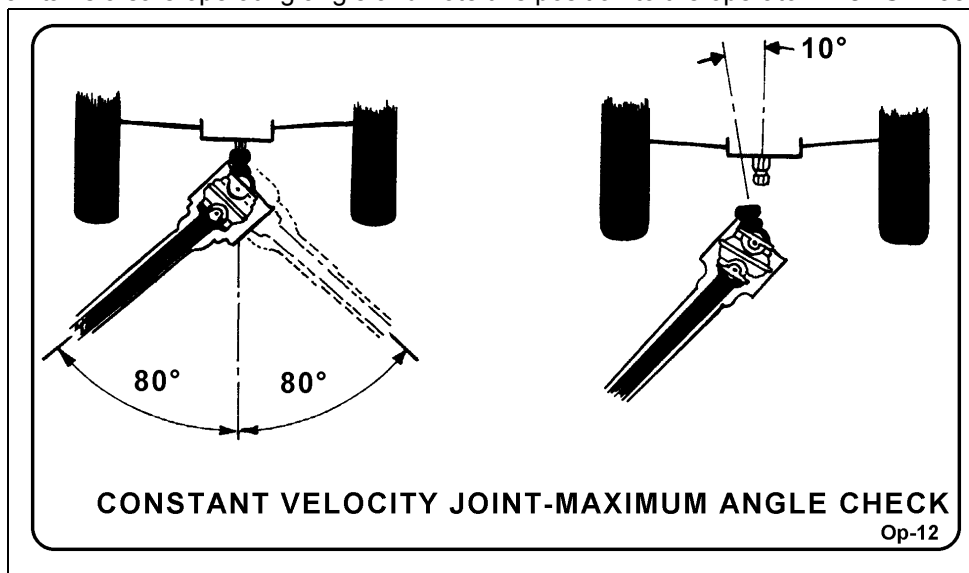

# OPERATION



The Constant Velocity PTO driveline is **HEAVY** (70 lbs or greater) and Special Lifting Procedures are recommended. Use lifting assistance such as mechanical assistance, two people, and proper lifting techniques when connecting or installing the driveshaft to reduce the possibility of back injuries.



Do not turn so sharp or lift mower so high to produce a severe "knocking" of the Driveline which will cause accelerated wear and breakage of drive train components and could result in possible injury from the separated Driveline sections. (SRM-04)

## 9. PRE-OPERATION INSPECTION AND SERVICE

Before each use, a pre-operation inspection and service of the implement and tractor must be performed. This includes routine maintenance and scheduled lubrication, inspecting that all safety devices are equipped and functional, and performing needed repairs. **DO NOT** operate the unit if the pre-operation inspection reveals any condition affecting safe operation. Perform repairs and replacement of damaged and missing parts as soon as noticed. By performing a thorough pre-operation inspection and service, valuable down time and repair cost can be avoided. *OPS-U-0029*



Always disconnect the main PTO Driveline from the Tractor before performing service on the Implement. Never work on the Implement with the tractor PTO driveline connected and running. Rotating Parts, Blades or Drivelines could turn without warning and cause immediate entanglement, injury or death. (S3PT-11)



**DO NOT** allow any person under a folded wing unless wing is securely locked up or supported. **DO NOT** approach the Implement unless the Tractor is turned off and all motion has ceased. Never work under the frame work, or any lifted component unless the implement is securely supported or blocked up. A sudden or inadvertent fall by any of these components could cause serious injury or even death. (STI-03)



Periodically inspect all moving parts for wear and replace when necessary with authorized service parts. Look for loose fasteners, worn or broken parts, and leaky or loose fittings. Make sure all pins have cotter pins and washers. Serious injury may occur from not maintaining this machine in good working order. (SG-21)

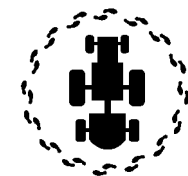

# OPERATION

## 9.1 Tractor Pre-Operation Inspection/Service

Refer to the tractor operator's manual to ensure a complete pre-operation inspection and scheduled service is performed according to the manufacturers recommendations. The following are some of the items that require daily service and inspection:

- Tire condition/air pressure
- Wheel lug bolts
- Steering linkage
- PTO shield
- SMV sign is clean and visible
- Tractor's lights are clean and functional
- Tractor Seat belt is in good condition
- Tractor ROPS is in good condition
- ROPS is in the raised position
- No tractor oil leaks
- Radiator free of debris
- Engine oil level and condition
- Engine coolant level and condition
- Power brake fluid level
- Power steering fluid level
- Fuel condition and level
- Sufficient lubrication at all lube points
- Air filter condition OPS-U-0030



## 9.2 Mower Pre-Operation Inspection/Service

Before each mower use, a complete inspection and service is required to ensure the mower is in a good and safe working condition. Damaged and/or broken parts should be repaired and/or replaced immediately. To ensure the mower is ready for operation, conduct the following. OPS-R-0007

### **⚠ DANGER**

All Safety Shields, Guards and Safety devices including (but not limited to) - the Deflectors, Chain Guards, Steel Guards, Gearbox Shields, PTO integral shields, and Retractable Door Shields should be used and maintained in good working condition. All safety devices should be inspected carefully at least daily for missing or broken components. Missing, broken, or worn items must be replaced at once to reduce the possibility of injury or death from thrown objects, entanglement, or blade contact. (SGM-3)

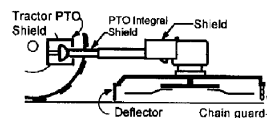

### **⚠ DANGER**

Replace bent or broken blades with new blades. NEVER ATTEMPT TO STRAIGHTEN, WELD, OR WELD HARDFACING ON BLADES SINCE THIS WILL LIKELY CRACK OR OTHERWISE DAMAGE THE BLADE WITH SUBSEQUENT FAILURE AND POSSIBLY CAUSE SERIOUS INJURY FROM THROWN BLADES. (SGM-10)

# OPERATION

The operator's manual and safety signs affixed on the unit contain important instructions on the safe and proper use of the equipment. Maintain these important safety features on the implement in good condition to ensure the information is available to the operator at all times.

- Ensure the manual canister is secured to the equipment with the operator's manual inside.
- Ensure all safety signs are in place and legible. Replace missing, damaged, and illegible decals. *OPS-U-0011*



- Ensure the mower hitch is securely attached to the tractor drawbar with a proper size bolt and secured nut.
- Ensure that a properly rated safety tow chain is equipped securing the mower to the tractor.
- Check that the main driveline is securely attached to the tractor and the clamping cone is seated in the groove of the PTO shaft.
- Ensure the divider drivelines are secure at both ends. *OPS-R-0008\_J*



- Ensure chain guards and/or rubber deflectors are in position and not damaged. Replace worn, broken, and missing sections immediately.
- Ensure the driveline integral shields are in good condition and rotate freely.
- Inspect that all bolts and screws are in position and are properly torqued. *OPS-R-0009*



# OPERATION

## OPERATION

- Ensure the tractor PTO master shield is in place, lowered and in good condition.
- Ensure each mower slip clutch shield is secured in place and in good condition.
- Ensure the driveline slip clutches are properly adjusted and the friction plates are not frozen together. Reference the Maintenance Section for proper slip clutch maintenance. *OPS-R-0010*



- Perform scheduled lubrication as specified in the maintenance section.
- Inspect each gearbox oil level removing level indicator plug. The oil should be level with the bottom of the hole the plug was removed from. Replenish if needed. Replace the plug. A low oil level is a warning sign that the gearbox may be cracked or its seal is damaged and needs to be replaced.
- Ensure all gearbox vents are in place and free from clogs. *OPS-R-0011\_N*

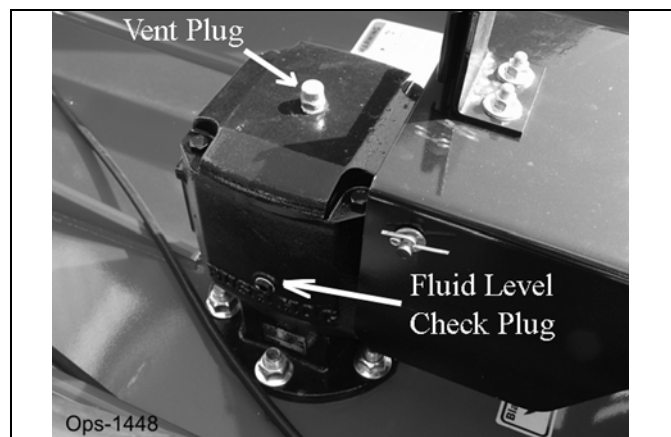

- Inspect blades and blade bolts for looseness and excessive wear. Make sure the mower is securely blocked up before crawling beneath. Replace damaged, worn, and missing blades as complete sets to maintain rotary balance.
- Ensure carrier hub nuts are tightened with the cotter pin inserted and spread.
- Inspect the condition of the deck skid shoes and the skid shoe attaching hardware. *OPS-R-0012*



# OPERATION

- Ensure each hydraulic cylinder is installed and retained correctly. Ensure the proper size pins are used to retain the cylinders in place and are secured with pins.
- Check for hydraulic oil leaks on the cylinders, along the hydraulic lines, and at tractor hydraulic ports. **IMPORTANT:** DO NOT use your hands to check for oil leaks. Use a piece of heavy paper or cardboard to check for hydraulic oil leaks.

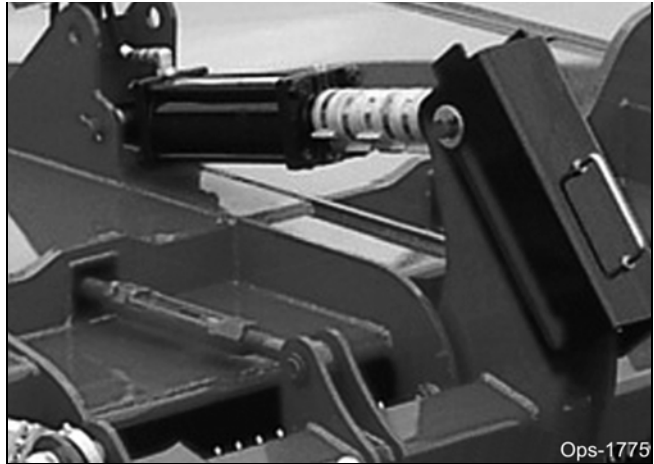

- Ensure that the mower is equipped and secured with wing transport locks.
- Check the condition of the wing hinge pins.
- Check the condition of the mower axle suspension spring.
- Inspect mower tire condition, wheel bearings, and lug nut torque.



# OPERATION

OPERATION

## 9.3 Cutting Component Inspection

Inspect blade pan and blade assembly for the following:

### Damaged Pan

**Cause:** Blade Pan contacts an immovable object while mower was in motion.

**Remedy:** Inspect the area before mowing to determine where the immovable objects are located and place visible hazard markers to identify the areas. Avoid mowing in the area where immovable foreign objects exist.

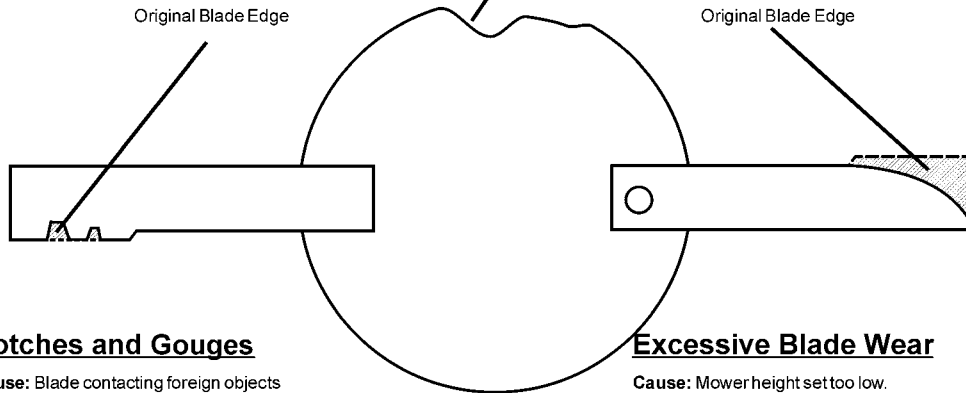

### Notches and Gouges

**Cause:** Blade contacting foreign objects

**Remedy:** Inspect the area to be mowed and remove foreign objects that could cause damage to the blades

### Excessive Blade Wear

**Cause:** Mower height set too low. Blade used past intended life.

**Remedy:** Replace blades more often. Adjust mower height for mowing Conditions to eliminate blade-to-ground contact

Op-22

OPS-U-0031

**Check Output Shaft Nut Torque.  
Maintain 600-ft-lbs.**

**Check Blade Bolt Torque.  
Torque to 600 ft-lbs.**

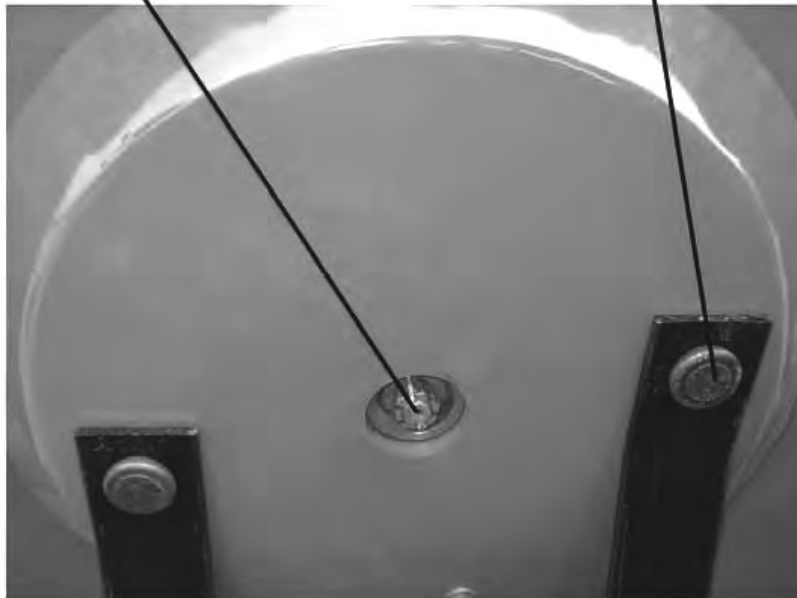



# OPERATION

## **WARNING**

Operating the mower with loose blade hardware will damage the blade holder or blades and can result in blade breakage or blade fastener failure. Broken blades or bolts can be thrown out from under the mower for distances up to 300 feet. When the blades are replaced, the fastening hardware must be replaced. Check and retighten the blade hardware after the first eight hours of operation. In severe cutting conditions, recheck the blade carrier and blade bolt torque every 50 hours.

## **Important**

To help prevent structural damage caused by loose hardware, tighten gearbox mounting hardware as specified. Check the fastener torque after first 8 hours of use and every 50 hours thereafter.

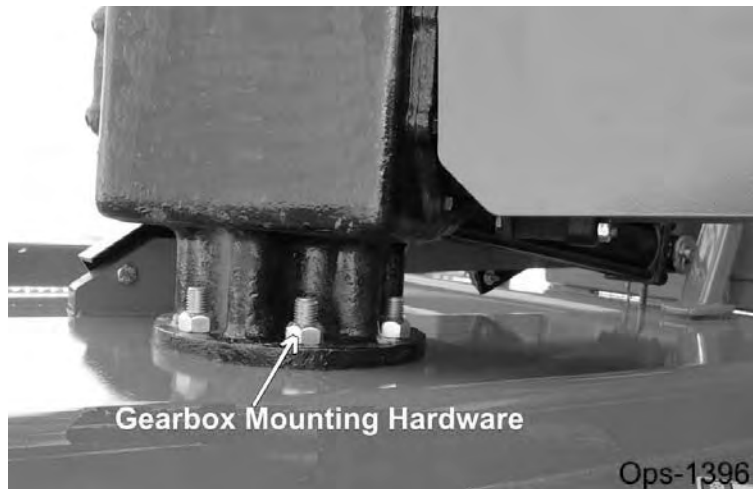

## **DANGER**

Inspect the Blades daily for abnormal wear. REPLACE BOTH BLADES on that carrier IMMEDIATELY if either blade has:

- Become bent or deformed from it's original shape or
- Any cracks are visible, or
- Deep gouges in the blade's surface are present, or
- Gouges or chipped areas in the cutting edge are larger than 1/2"(12.7mm), or
- The material on the leading edge has been worn away by more than 1/2(12.7mm)"

Failure to replace abnormally worn blades may lead to catastrophic failure of the blades and ejection of the broken part with tremendous force which may cause serious bodily injury or death. OPS-U-0032

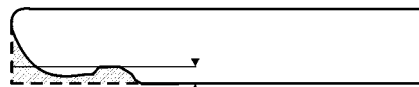

1/2" MAXIMUM  
(12.7mm)

Original Blade Edge

**NOTE:**  
Replace Blades in pairs after no more than 1/2" (12.7mm) wear  
Op-23

# OPERATION

OPERATION

## 9.4 Blade Bolt Inspection

Inspect Blade Bolt Head daily for wear as followed:

### Excessive Blade Bolt Wear

**Cause:** Blade Bolt contacts a foreign or solid object while Blade is in motion.

**Remedy:** Inspect the area before mowing to determine where the foreign objects are located and place visible hazard markers to identify the areas where immovable foreign objects exist, and avoid hitting the objects.

### Notches and Gouges

**Cause:** Blade Bolt contacting foreign objects.

**Remedy:** Inspect area to be mowed and remove foreign objects that could cause damage to the blade bolt.

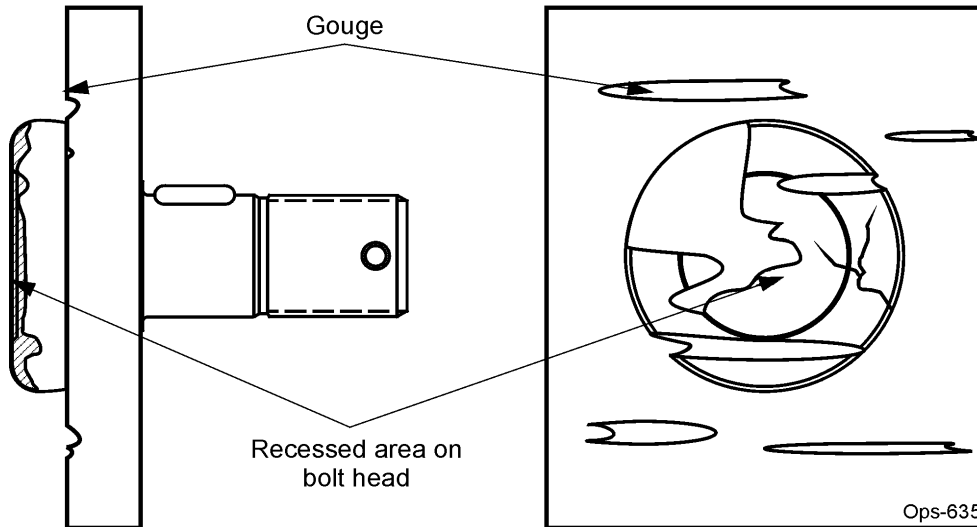

**⚠ DANGER**

Inspect the Blade Bolt Heads daily for abnormal wear. REPLACE BOTH BLADE BOLTS on the Blades IMMEDIATELY if either blade bolts has:

- Visible cracks or
- If the recessed area on blade bolt is worn off or
- If Blade Bolt has gouges or chipped areas.

Failure to replace abnormally worn blade bolts may lead to catastrophic failure of the blades and ejection of the broken part which may cause serious bodily injury or death.

**Always replace Blade Bolts with new bolts whenever replacing the Blades. OPS-U-0037**

# OPERATION

## Rotary Mower PRE-OPERATION Inspection



Mower ID# \_\_\_\_\_

Date: \_\_\_\_\_

**IMPORTANT:** Scan this QR Code for an electronic copy of this inspection sheet.



[www.algqr.com/rmi](http://www.algqr.com/rmi)



**Before conducting the inspection, make sure the tractor engine is off, all rotation has stopped and the tractor is in park with the parking brake engaged. Make sure the mower is resting on the ground or securely blocked up and all hydraulic pressure has been relieved.**

Item	Condition at Start of Shift	Specific Comments if not O.K.
The Operator's Manual is in the canister on the mower		
All safety decals are in place and legible		
The tongue/hitch connection bolts & pins are tight		
There are no cracks in tongue or hitch		
The tow chain is secured to the tractor & mower		
The hydraulic cylinders pins are tight		
There are no leaking or damaged hoses		
The mower deck is clear of cut grass and debris		
Chain guards/deflectors are in place & in good condition		
Driveline/gearbox shields are in good condition		
Driveline clutches are in good condition; not frozen		
Driveline telescoping members & U-joints are lubricated		
Driveline yokes are securely attached to PTO & mower		
Gearbox mounting bolts are tight		
Gearbox oil is at the proper level		
Blade carrier retaining nut is tight		
Blades are not chipped, cracked or bent		
Blade bolts are tight		
Wheel lug nuts are tight		
Transport locks are in good condition		

Make \_\_\_\_\_

Shift \_\_\_\_\_

Operator's Signature: \_\_\_\_\_

**DO NOT OPERATE an UNSAFE TRACTOR or MOWER**

**OPERATION**

# OPERATION

## Tractor PRE-OPERATION Inspection



Tractor ID#: \_\_\_\_\_ Make: \_\_\_\_\_

Date: \_\_\_\_\_ Shift: \_\_\_\_\_



**Before conducting the inspection, make sure the tractor engine is off, all rotation has stopped and the tractor is in park with the parking brake engaged. Make sure the implement is resting on the ground or securely blocked up and all hydraulic pressure has been relieved.**

**OPERATION**

Item	Condition at Start of Shift	Specific Comments if not O.K.
The flashing lights function properly		
The SMV Sign is clean and visible		
The tires are in good condition with proper pressure		
The wheel lug bolts are tight		
The tractor brakes are in good condition		
The steering linkage is in good condition		
There are no visible oil leaks		
The hydraulic controls function properly		
The ROPS or ROBS Cab is in good condition		
The seatbelt is in place and in good condition		
The 3-point hitch is in good condition		
The drawbar pins are securely in place		
The PTO master shield is in place		
The engine oil level is full		
The brake fluid level is full		
The power steering fluid level is full		
The fuel level is adequate		
The engine coolant fluid level is full		
The radiator is free of debris		
The air filter is in good condition		

Operator's Signature: \_\_\_\_\_

**DO NOT OPERATE an UNSAFE TRACTOR or IMPLEMENT**

# OPERATION

## 10. DRIVING THE TRACTOR AND IMPLEMENT

Safe tractor transport requires the operator possess a thorough knowledge of the model being operated and precautions to take while driving with an attached implement. Ensure the tractor has the capacity to handle the weight of the implement and the tractor operating controls are set for safe transport. To ensure safety while driving the tractor with an attached implement, review the following. *OPS-U- 0012*

### **▲ DANGER**

This Implement may be wider than the Tractor. Be careful when operating or transporting this equipment to prevent the Implement from running into or striking sign posts, guard rails, concrete abutments or other solid objects. Such an impact could cause the Implement and Tractor to pivot violently resulting in loss of steering control, serious injury, or even death. Never allow the Implement to contact obstacles. (S3PT-12)

### **▲ WARNING**

Transport only at speeds where you can maintain control of the equipment. Serious accidents and injuries can result from operating this equipment at high speeds. Understand the Tractor and Implement and how it handles before transporting on streets and highways. Make sure the Tractor steering and brakes are in good condition and operate properly.



Before transporting the Tractor and Implement, determine the proper transport speeds for you and the equipment. Make sure you abide by the following rules:

Test the tractor at a slow speed and increase the speed slowly. Apply the Brakes smoothly to determine the stopping characteristics of the Tractor and Implement. As you increase the speed of the Tractor the stopping distance increases. Determine the maximum transport speed not to exceed 20 mph (30 kph) for transporting this equipment.

Test the equipment at a slow speed in turns. Increase the speed through the turn only after you determine that the equipment can be operated at a higher speed. Use extreme care and reduce your speed when turning sharply to prevent the tractor and implement from turning over. Determine the maximum turning speed for you and this equipment before operating on roads or uneven ground.

Only transport the Tractor and Implement at the speeds which allow you to properly control the equipment.

Be aware of the operating conditions. Do not operate the Tractor with weak or faulty brakes or worn tires. When operating down a hill or on wet or rain slick roads, the braking distance increases: use extreme care and reduce your speed. When operating in traffic always use the Tractor's flashing warning lights and reduce your speed. Be aware of traffic around you and watch out for the other guy. (SG-19)

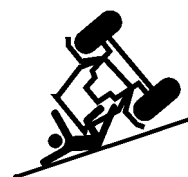

# OPERATION

## **10.1 Starting the Tractor**

The procedure to start the tractor is model specific. Refer to the tractor operator's manual for starting procedures for your particular tractor. Consult an authorized dealer if the starting procedure is unclear. Ensure the 3-point control lever is in the lowered position and the PTO is disengaged before starting the tractor. OPS-U-0033



## **10.2 Brake and Differential Lock Setting**

Make sure the tractor brakes are in good operating condition. Tractor brakes can be set to operate independently allowing single rear wheel braking action or locked together to provide simultaneous rear wheel braking. FOR MOST DRIVING AND OPERATING CONDITIONS, THE BRAKE PEDALS SHOULD BE LOCKED TOGETHER TO PROVIDE THE MOST EFFECTIVE BRAKING ACTION.

Always disengage the tractor differential lock when turning. When engaged the differential lock will prevent or limit the tractor from turning. During normal cutting conditions, locking the differential provides no benefit and should not be used. OPS-U-0013



Be aware of the operating conditions. Do not operate the Tractor with weak or faulty brakes. When operating down a hill or on wet or rain slick roads, the braking distance increases; use extreme care and reduce your speed in these conditions. When operating in traffic, always use the Tractor's flashing warning lights and reduce your speed. Be aware of traffic around you and watch out for the other guy.

## **10.3 Operating the Mower Wings**

Wings are positioned with hydraulic cylinders. It is recommended that the tractor be equipped with three hydraulic ports or a 3-spool control valve be used so that each section can be controlled independently. Ensure the hydraulic cylinders and lines are filled with oil by holding the valve control levers in the raised position until the cylinders fully retract (wings) and extend (center). Only operate the mower with both wings fully lowered, NEVER operate the mower with a raised wing. Wait until the blades are at a complete stop before raising wings. OPS-R-0015

# OPERATION

## **10.4 Transport Position**

To raise mower wings, drive the unit to a level area and retract the wing hydraulic cylinders. DO NOT raise wings with the mower positioned on an embankment or other inclined position to prevent overturning the mower. After the wings are fully raised, install transport lock pins to prevent wings from inadvertently falling. **NOTE:** *If the transport lock pins can not be easily installed, lower the mower wings and remove rod end of cylinder and adjust the rod clevis in or out to match the transport lock pins.*

The center of gravity is raised and the mower more prone to tipping when the wings are in the raised position. When transporting, raise the center section high enough to clear ground obstacles. OPS-R-0016\_F

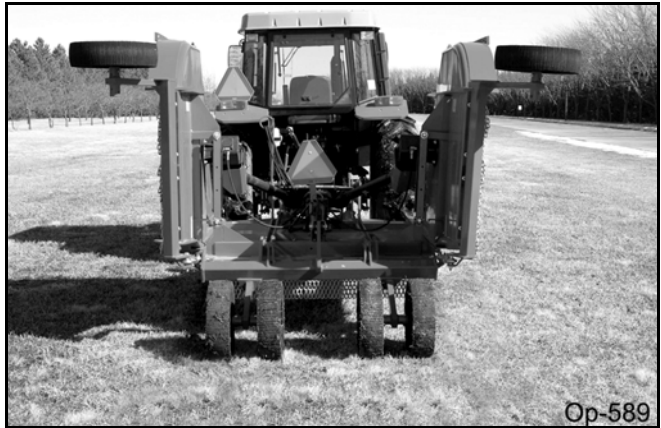

When the Wings are folded for transport, the center of gravity is raised and the possibility of overturn is increased. Drive slowly and use extreme caution when turning on hillsides. Overturning the Implement could cause the Implement to overturn the Tractor and vice versa resulting in serious injury or even death. Never fold wings on a hillside...the Implement or unit may overturn. (STI-02)

## **10.5 Operating Position**

To lower the wings, remove the transport lock pins and secure pins on storage bracket. DO NOT drive out transport lock pins. The wing cylinder may need to be retracted to remove tension for lock pin removal. After removing lock pins, extend wing hydraulic cylinders and fully lower wings.

The valves operating wing cylinders should be placed in the float position while mowing to allow the mower to follow the contour of uneven terrain and to prevent the wings from creeping up. When extending a wing over a ditch for mowing, place the control valve lever detents in the center position. This will give the mower more stability and prevent the opposite wing from raising. DO NOT operate the mower with the valves in the detent position for extended periods of time to prevent deck frame damage. OPS-R-0017\_G



# OPERATION

## **WARNING**

Use extreme care when lowering or unfolding the implement's wings. Make sure no bystanders are close by or underneath the wings. Allow ample clearance around the implement when folding or unfolding the wings. Use extreme caution around buildings or overhead power lines. (S3PT-05)

### **10.6 Driving the Tractor and Cutter**

Start off driving at a slow speed and gradually increase your speed while maintaining complete control of the tractor and mower. Moving slowly at first will also prevent the tractor from rearing up and loss of steering control. The tractor should never be operated at speeds that cannot be safely handled or which will prevent the operator from stopping quickly during an emergency. If the power steering or engine ceases operating, stop the tractor immediately as the tractor will be difficult to control.

Drive the tractor with the 3-Point lift arms in the raised position and lock the control lever in the transport detent position to prevent damage to the mower driveline and tongue when turning.

Perform turns with the tractor and mower at slow speeds to determine how the tractor with an attached mower handles a turn. Determine the safe speed to maintain proper control of the tractor when making turns. When turning with a towed implement, the overall working length of the unit is increased. Allow additional clearance for the mower when turning..



To avoid overturns, drive the tractor with care and at safe speeds, especially when operating over rough ground, crossing ditches or slopes, and turning corners. Tractor wheel tread spacing should be increased when working on inclines or rough ground to reduce the possibility of tipping.

Use extreme caution when operating on steep slopes. Keep the tractor in a low gear when going downhill. DO NOT coast or free-wheel downhill. OPS-R-0018





# OPERATION

## **10.7 Crossing Ditches and Steep Inclines**

When crossing ditches with steep banks or going up sharp inclines, it is possible that the main driveline inner profile will penetrate into the outer housing to its maximum depth until the assembly becomes solid (driveline is at its extreme shortest length). This type of abusive operation can cause serious damage to the tractor and mower drive by pushing the PTO into the tractor and through the support bearings or downward onto the PTO shaft, breaking it off.

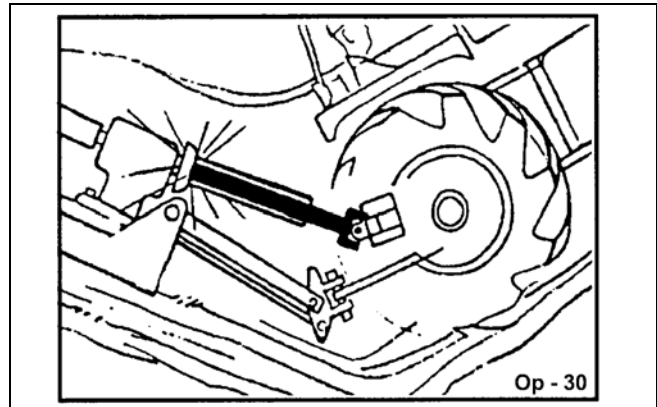

### **WARNING**

Damage resulting from over-collapse of the driveline's inner profile and its outer housing may allow the driveline to come loose from the Tractor which could cause bodily injury to the operator or bystanders and/or extensive damage to the Tractor or Implement. OPS-R-0020

When confronted with an incline or ditch, do not approach from an angle which is perpendicular or straight on as damaged to over collapse of the driveline may occur.

When crossing such terrain, the implement should be fully lowered for a lower center of gravity and added stability. OPS-R-0021

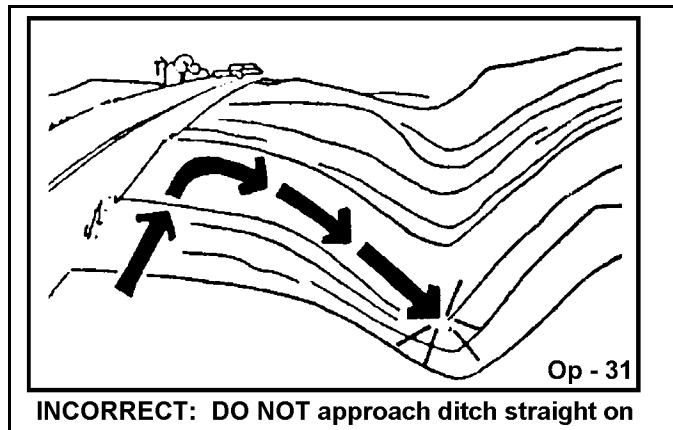

# OPERATION

Inclines and ditches should be approached along a line which is at an angle as shown. This type of path will reduce the possibility of over-collapse of the driveline and resulting damage. If the gradient is so steep that such an approach increases the possibility of a tractor roll-over, select an alternate crossing path.

When operating the tractor and mower across slopes and inclines, through ditches, and other uneven terrain conditions, it is important to maintain sufficient deck to ground clearance. Blade contact with the ground may cause soil, rocks and other debris to be thrown out from under the mower resulting in possible injury and/or property damage. Ground contact also produces a severe shock load on the mower drive and to the mower blades resulting in possible damage and premature wear.  
*OPS-R-0022*

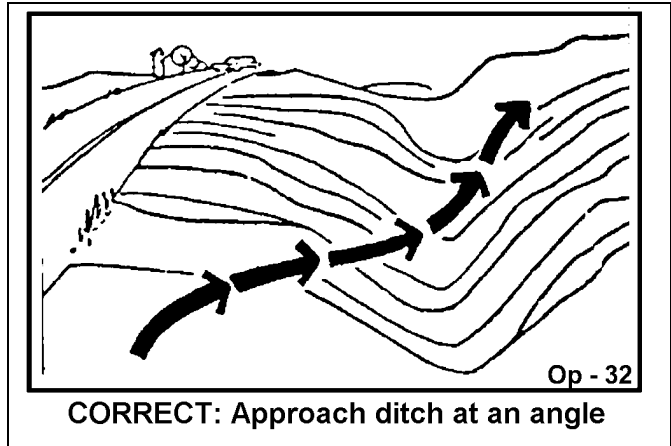

## 11. OPERATING THE TRACTOR AND IMPLEMENT

**THE OPERATOR MUST COMPLETELY UNDERSTAND HOW TO OPERATE THE TRACTOR AND IMPLEMENT AND ALL CONTROLS BEFORE ATTEMPTING TO OPERATE.** The operator must read and understand the Safety and Operation Sections of the implement and tractor operator's manuals. These manuals must be read and explained to any operator who cannot read. Never allow someone to operate the implement and tractor without complete operating instructions.

Before starting any operation, the operator must become familiar with the area to be worked in and any obstacles and hazards contained within to ensure safety to the operator, bystanders, and equipment. Special attention should be paid to foreign debris, rough terrain, steep slopes, and passersby and animals in the area.  
*OPS-U-0015*



Extreme care should be taken when operating near loose objects such as gravel, rocks, wire, and other debris. Inspect the area before mowing. Foreign objects should be removed from the site to prevent machine damage and/or bodily injury or even death. Any objects that cannot be removed must be clearly marked and carefully avoided by the operator. Stop mowing immediately if blades strike a foreign object. Repair all damage and make certain rotor or blade carrier is balanced before resuming mowing. (SGM-05)



# OPERATION

## **WARNING**

Many varied objects, such as wire, cable, rope, or chains, can become entangled in the operating parts of the mower head. These items could then swing outside the housing at greater velocities than the blades. Such a situation is extremely hazardous and could result in serious injury or even death. Inspect the cutting area for such objects before mowing. Remove any like object from the site. Never allow the cutting blades to contact such items.

(SGM-06)

### **11.1 Foreign Debris Hazards**

Before mowing, inspect the area to make sure there are no foreign objects that the mower blades could hit or become entangled with. Remove all foreign objects and debris. If objects are too big to remove, mark them clearly and be sure to prevent the mower blades from contacting them.

If you hit a solid object or foreign debris, stop the mower and tractor at once. Immediately idle the engine speed and disengage the PTO. Wait for all mower rotating motion to stop, then raise the mower and move the tractor and implement off the object. Inspect the area and remove, or mark the location of the debris. Inspect the condition of the mower and make any needed repairs immediately. Make sure the blades are not damaged and the carrier is balanced before resuming operation.

Always wear your seat belt securely fastened and only operate the tractor and mower with the ROPS in the raised position. If the tractor or mower hits a tree stump, rock, or bump, a sudden movement could throw you off of the seat and under the tractor and/or mower. The seat belt is your best protection from falling off the tractor and the ROPS provides protection from being crushed during a tractor roll-over. *OPS-R-0023*



Op - 33

**Remove Foreign Material**



Op-151

**Raise Mower over solid objects**

### **11.2 Bystanders/Passersby Precautions**

If a bystander comes within 300 feet of the tractor while the mower is being operated, stop the tractor at once, idle the engine and disengage the PTO. Do not engage the PTO again until all bystanders are well past the 300 foot distance. *OPS-R-0024*

# OPERATION

## **DANGER**

Rotary Mowers are capable under adverse conditions of throwing objects for great distances (300 ft (100 m) or more) and causing serious injury or death. Follow safety messages carefully.



### **STOP MOWING IF PASSERSBY ARE WITHIN 300 Feet (100 m) UNLESS:**

- Front and Rear Deflectors, Chain Guards, or Bands are installed and in good, workable condition;
- Mower sections or Wings are running close to and parallel to the ground without exposed Blades;
- Passersby are outside the existing thrown-object zone;
- All areas have been thoroughly inspected and all foreign material such as rocks, cans, glass, and general debris has been removed.

**NOTE:** *Where there are grass and weeds high enough to hide debris that could be struck by the blades, the area should be: inspected and large debris removed, mowed at an intermediate height, inspected, closely with any remaining debris being removed, and mowed again at desired final height. (This will also reduce power required to mow, reduce wear and tear on the Mower drivetrain, spread cut material better, reduce streaking, and make the final cut more uniform).* (SRM-01)

## **11.3 Engaging the Power Take Off (PTO)**

Before engaging the PTO, make certain that the area is clear of bystanders and passersby. The implement must be completely lowered and the deck positioned at a safe operating height. NEVER engage the PTO with the implement in the raised position.

Set the tractor engine speed at approximately 1,000 RPM before engaging the PTO. Shift the PTO control to the on position, and slowly increase the engine speed until the PTO is operating at the rated speed. If you hear unusual noises or see or feel abnormal vibrations, disengage the PTO immediately. Inspect the implement to determine the cause of the noise or vibration and repair the abnormality. OPS-U- 0027

## **WARNING**

Do not let the Blades turn when the Mower Deck is raised for any reason, including clearance or for turning. Raising the Mower deck exposes the Cutting Blades which creates a potentially serious hazard and could cause serious injury or even death from objects thrown from the Blades. (SRM-07)



## **WARNING**

Do not put hands or feet under mower decks. Blade Contact can result in serious injury or even death. Stay away until all motion has stopped and the decks are securely blocked up. (SGM-09)



# OPERATION

## **11.4 PTO RPM and Ground Speed**

Ground speed for mowing will depend upon the height, type, and density of vegetation to be cut. Recommended speed for efficient mower performance is between 2 and 5 mph(3-8 kph). Operate the mower at its full rated PTO speed to maintain blade speed for a clean cut. Refer to the tractor operator's manual or the tractor instrument panel for the engine speed and gear to provide the required PTO and desired ground speed. Make sure that the mower is operating at its full rated speed before entering the vegetation to be cut. If it becomes necessary to temporarily regulate engine speed, increase or decrease the throttle gradually.

Ground speed is achieved by transmission gear selection and not by the engine operating speed. The operator may be required to experiment with several gear range combinations to determine the best gear and range which provides the most ideal performance from the mower and most efficient tractor operation. As the severity of cutting conditions increase, the ground speed should be decreased by selecting a lower gear to maintain the proper operating PTO speed. OPS-R-0025



Do not exceed the rated PTO speed for the Implement. Excessive PTO speeds can cause Implement driveline or blade failures resulting in serious injury or death. (SG-26)



Mow at the speed that you can safely operate and control the tractor and mower. The correct mowing speed depends on terrain condition and grass type, density, and height of cut. Normal ground speed range is from 2 to 5 mph(3-8 kph). Use slow mowing speeds when operating on or near steep slopes, ditches, drop-offs, overhead obstructions, power lines, or when debris and foreign objects are to be avoided. (SGM-07)

## **11.5 Operating the Mower**

Only operate the mower from the tractor operator's seat with the seatbelt securely fastened. The tractor must be equipped with a ROPS in the raised position or a ROPS cab.

The mower is designed to cut vegetation up to 2"(50.8mm) in diameter. Sharp blades will produce a cleaner cut and require less power. Travel at a speed that allows the mower sufficient time to cut through the vegetation and maintain the PTO operating speed to prevent overloading the mower and tractor. Choose a driving pattern that provides the maximum pass length and minimizes turning.

Under certain conditions, tractor tires may roll some grasses down preventing them from being cut at the same height as the surrounding area. When this occurs, reduce the tractor ground speed while maintaining the operating speed of the mower. A slower ground speed will permit grasses to at least partially rebound and be cut. Taking a partial cut and/or reversing the direction of travel may also help produce a cleaner cut. Check tire spacing as noted in Tractor Operators Manual.

Avoid mowing in the reverse direction when possible. In situations where the mower must be backed to access areas to be cut, make sure there are no persons or other foreign debris behind the mower before mowing in reverse. When mowing in reverse, operate the tractor and mower at a reduced ground speed to ensure tractor and mower control is maintained

# OPERATION

**WARNING**

Do not mow with two machines in the same area except with Cab tractors with the windows closed. (SGM-11)

**WARNING**

Mow only in conditions where you have clear visibility in daylight or with adequate artificial lighting. Never mow in darkness or foggy conditions where you cannot clearly see at least 300 feet (90 m) in front and to the sides of the tractor and mower. Make sure that you can clearly see and identify passersby, steep slopes, ditches, drop-offs, overhead obstructions, power lines, debris and foreign objects. If you are unable to clearly see these type of items discontinue mowing. (SGM-1)

**WARNING**

Avoid mowing in reverse direction when possible. Check to make sure there are no persons behind the mower and use extreme care when maneuvering in reverse. Mow only at a slow ground speed where you can safely operate and control the tractor and mower. Never mow an area that you have not inspected and removed debris or foreign material. (SGM-08)

**WARNING**

Follow these guidelines to reduce the risk of equipment and grass fires while operating, servicing, and repairing the Mower and Tractor:



- Equip the Tractor with a fire extinguisher in an accesible location.
- Do Not operate the Mower on a Tractor with an underframe exhaust.
- Do Not smoke or have an open flame near the Mower and Tractor.
- Do Not drive into burning debris or freshly burnt areas.
- Ensure slip clutches are properly adjusted to prevent excessive slippage and plate heating.
- Never allow clippings or debris to collect near drivelines, slip clutches, and gearboxes. Periodically shut down the Tractor and Mower and clean clippings and collected debris from the mower deck. (SGM-12)

# OPERATION

When you get to the end of a pass, slightly raise the mower (2-4") before turning. Never raise the mower entirely while the blades are turning. If the mower must be raised higher than 12" from ground level, disengage the tractor PTO and wait for all mower rotation to come to a complete stop before proceeding to raise the mower. NEVER raise the mower wings while the blades are turning.

When turning, the angle between the tractor and mower should not be so great that a clattering of the U-joints occurs. Sharp turns can cause premature failure of the joints and place pressure on the tractor PTO shaft and could cause extensive mechanical damage to the mower and tractor.

If the mower is operated in conditions that require frequent sharp turning, the mower should be equipped with a Constant Velocity driveline. CV joints enable the tractor PTO shaft and mower driveline to be angled safely up to 80 degrees with no damage to the mower or driveline. OPS-R-0027



OPERATION

## **WARNING**

Do not let the Blades turn when the Mower Deck is raised for any reason, including clearance or for turning. Raising the Mower deck exposes the Cutting Blades which creates a potentially serious hazard and could cause serious injury or even death from objects thrown from the Blades. (SRM-07)



Stay alert and watch for trees, low hanging limbs, power lines, and other overhead obstacles and solid ground objects while you are operating. Use care to avoid hitting these items. OPS-R-0028



# OPERATION

When mowing across uneven areas such as road shoulders, ditch edges, and other uneven terrain, position mower so that one support wheel is near the highest point to prevent blades from cutting into gravel or dirt which can cause rapid blade wear and extremely severe shock loads on the drivetrain resulting in rapid wear or damage to these components. Blades contacting the ground may cause objects to be thrown out from under the mower deck. Always avoid operating the mower at a height or position which may cause the blades to contact the ground. Cutting into the berm or edge of the ditch will cause abnormal and accelerated blade wear and possible blade component failure. OPS-R-0029

OPERATION

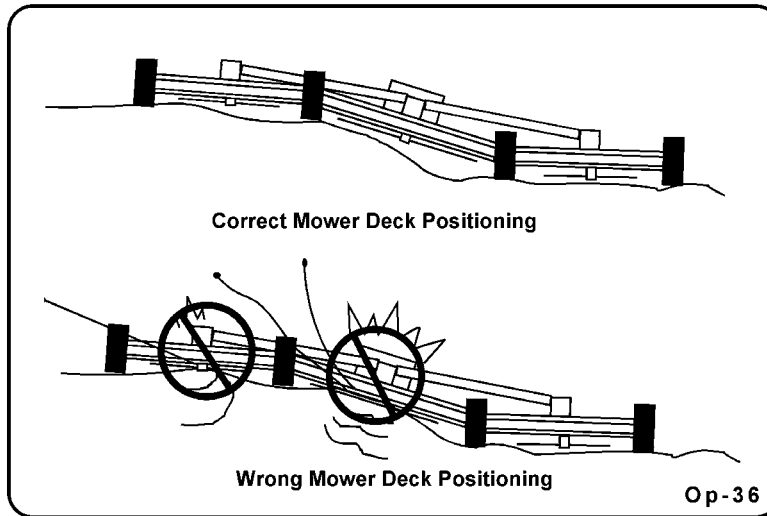



# OPERATION

## **11.6 Right of Way (Highway) Mowing**

- **USE DOUBLE CHAIN GUARDS** for highway, right-of-way, parks, greenbelt mowing, or all other mowing where human dwellings, vehicles, or livestock could be within 300 feet of the mower.
- No shielding is 100% effective in preventing thrown objects. To Reduce Possibility of Injury:
  1. **MAINTAIN MOWER SHIELDING** in good operational condition,
  2. **DAILY INSPECT** the condition of the Thrown Object Guards, mower Side Skirts, and skid shoes: Replace or repair worn or damaged guards.
  3. **DAILY INSPECT** the condition of the Blades and Blade Bolts. Replace any cracked, worn, bent or damage blades. Always replace blade bolts and nuts when replacing blades. Make sure the blade bolts are properly tightened.
  4. **RAISE CUTTING HEIGHT** to **6 INCHES** minimum.
  5. **INSPECT AREA** thoroughly before mowing to **REMOVE** potential **THROWN OBJECT HAZARDS**.
  6. **NEVER ALLOW BLADES** to **CONTACT SOLID OBJECTS** like wire, rocks, posts, curbs, guardrails, or ground while mowing.



**ROTARY MOWERS CAN THROW OBJECTS 300 FEET OR MORE UNDER ADVERSE CONDITIONS.**

**TO AVOID SERIOUS INJURY OR DEATH TO OPERATOR OR BYSTANDERS FROM THROWN OBJECTS:**

**INSPECT AREA FOR POTENTIAL THROWN OBJECTS BEFORE MOWING:**

- **REMOVE** debris, rocks, wire, cable, metal objects and other foreign material from area.

Wire, cable, rope, chains and metal objects can be thrown or swung outside deck with great velocity:

1. **MARK** objects that cannot be removed.
2. **AVOID** these objects when mowing.

**STOP MOWING IF PASSERSBY IS WITHIN 300 FEET UNLESS:**

- All **THROWN OBJECT SHIELDING** including Front and Rear Deflectors, Chain Guards, Steel Guards, Bands, Side Skirts and Skid Shoes are in place and in good condition when mowing.
- Mower sections or wings are adjusted to be close and parallel to ground without exposing blades.
- **MOWING AREA** has been inspected and foreign materials and debris have been removed.
- **PASSERSBY** are inside enclosed vehicle. *OPS-U-0040*

# OPERATION

## 11.7 Shutting Down the Implement

To shut down attached mower head, first bring the tractor to a complete stop. Decrease engine RPM to idle then disengage cutterhead. The mower head will come to a complete stop within a suitable amount of time. Do not engage or disengage the cutterheads at a high RPM unless there is an emergency situation.



Park the tractor on a level surface, place the transmission in park or neutral and apply the parking brake, lower the attached implement to the ground, shut down the engine, remove the key, and wait for all motion to come to a complete stop before exiting the tractor. *OPS-U-0016*



## 12. DISCONNECTING THE MOWER FROM THE TRACTOR

Before disconnecting the mower, the PTO must be disengaged and blade rotation at a complete stop. Move the mower to a level storage location and lower the center section and both wings to the ground. If the mower will be stored with the wings in the raised position, install both wing transport lock pins. If the mower is not resting securely on the ground, block the mower up securely before attempting to disconnect it from the tractor.

Use extreme care to keep feet and hands from under the mower and clear of any pinch points. *OPS-R-0030\_G*



Always shut the Tractor completely down, place the transmission in park, and set the parking brake before you or anyone else attempts to connect or disconnect the Implement and Tractor hitches. (S3PT-15)

# OPERATION

## **WARNING**

Never unhitch without using the Tongue Jack. The Tongue is very heavy. Attempting to lift the Tongue without using the Tongue Jack could cause strains or other injury. Allowing the tongue to fall suddenly and unexpectedly could result in crushing injury. Use the Tongue Jack for lifting the Implement only. Overloading the Tongue Jack can cause failure with possible serious bodily injury or even death. (STI-04)

When disconnecting the mower the tractor should be completely shut down and secured in position. Relieve hydraulic pressure by moving the control levers back and forth several times. Lower the parking jack and raise the mower until the tongue clevis is no longer resting on the tractor drawbar and is supported solely by the jack. The jack should be in a near vertical position with the ground and can be adjusted by loosening the positioning nut and moving the jack up to 15 degrees in each direction. Also make sure that the jack foot is securely resting at ground level or securely supported by a block before raising the mower. Once the mower tongue is being supported entirely by the jack, remove the hitch bolt, locknut, and washers. Remove the hydraulic hoses from the tractor and secure to the mower to prevent contact with dirt.

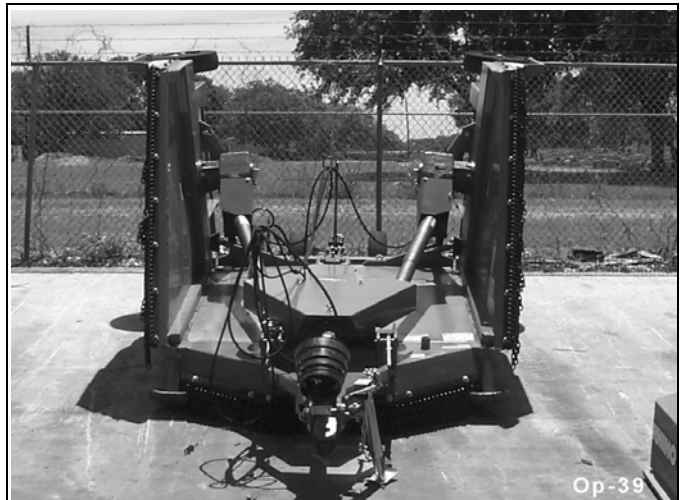

After disconnecting the mower hitch, remove the mower driveline from the tractor PTO shaft. Place the driveline in its storage bracket to prevent it from contacting mud or dirt which can contaminate the universal joint bearings and shorten the life of the driveline.



After the driveline has been removed from the tractor, place the PTO master shield back in the operating position. OPS-R-0031

# OPERATION

## 13. MOWER STORAGE

It is recommended that the mower be stored with the center section and both wings fully lowered to ground level. If the mower is stored with the wings in the raised position, select a level area and install wing transport lock pins to prevent the wings from falling BEFORE disconnecting the mower hitch from the tractor.

Properly preparing and storing the mower at the end of the season is critical to maintaining its appearance and to help ensure years of dependable service. The following are suggested storage procedures:

- Thoroughly clean all debris off the mower to prevent damage from rotting grass and standing water.
- Lubricate all mower grease points and fill gearbox oil levels as detailed in the maintenance section.
- Tighten all bolts and pins to the recommended torque.
- Check the mower for worn and damaged parts. Perform repairs and make replacements immediately so that the mower will be ready for use at the start of the next season.
- Store the mower in a clean, dry place with the mower housing resting securely on blocks or at ground level.
- Keep the driveline yoke from sitting in water, dirt and other contaminants.
- Use spray touch-up enamel where necessary to prevent rust and maintain the appearance of the mower.



It is critical that driveline clutches slip when an obstacle or heavy load is encountered to avoid mower and/or tractor damage. If the mower sits outside for an extended period of time or is exposed to rain and/or humid air, the clutch lining plates must be inspected to ensure they are not frozen together from rust or corrosion. If the mower has been exposed to such conditions, at the start of each mowing season, and any time it is suspected that the slip clutch plates may be frozen together, readjust the slip clutch as detailed in Seasonal Clutch Maintenance of the maintenance section in this manual. OPS-R-0032\_H



Never allow children to play on or around Tractor or Implement. Children can slip or fall off the Equipment and be injured or killed. Inadvertent contact with controls can cause the Implement to shift or fall crushing themselves or others. (SG-25)

## 14. TRANSPORTING THE TRACTOR AND IMPLEMENT

Inherent hazards of operating the tractor and implement and the possibility of accidents are not left behind when you finish working in an area. Therefore, the operator must employ good judgement and safe operation practices when transporting the tractor and implement between locations. By using good judgement and following safe transport procedures, the possibility of accidents while moving between locations can be substantially minimized. OPS-U-0017

# OPERATION



Never allow children or other persons to ride on the Tractor or Implement. Falling off can result in serious injury or death. (SG-10)



OPERATION

Before transporting the tractor and mower, idle the tractor engine, disengage the PTO and wait for all mower moving parts to come to a complete stop. Once all mower parts are completely stopped, raise the mower to transport height. **NOTE:** When raising the mower, maintain at least 1" clearance between the driveline and mower deck. If additional mower deck height is needed for safe transport, disconnect the driveline from the tractor and secure its end to the mower deck. The mower can then be raised to the maximum lift height.. OPS-R-0033



If the tractor's hydraulic pump is not independent of the tractor PTO, or if the tractor PTO has to be run to have hydraulic power, disconnect the mower driveline from the tractor PTO output shaft. Secure the driveline to the mower deck to prevent driveline damage or loss during transport. OPS-R-0034



Before transporting the tractor on a public roadway or boarding a trailer for transport, the tractor brake pedals should be locked together. Locking the pedals ensures that both wheels brake simultaneously while stopping, especially when making an emergency stop.

Use extreme caution and avoid hard applications of the tractor brakes when towing heavy loads at road speeds. Never tow the implement at speeds greater than 20 MPH (32 kph). OPS-U- 0018

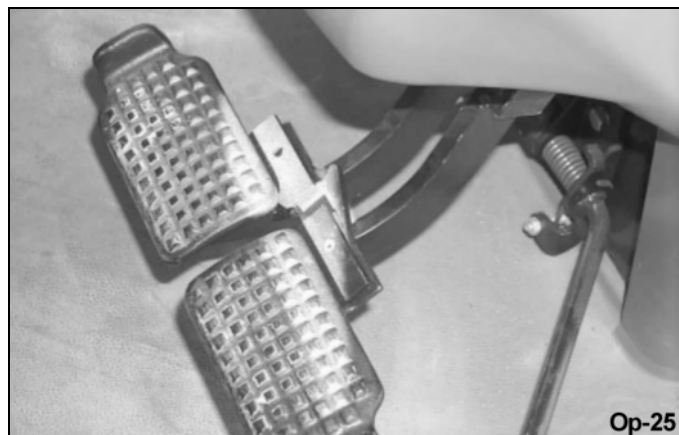

# OPERATION

## 14.1 Tire and Wheels

**Laminated Sectional Tires** are designed for conditions where puncture proof performance is required and the mower will not be transported for long distances on roadways. Transport speed for laminated tires should not exceed 15 MPH. Excessive speed can cause damage to the machine and tire sections. Laminated tires must be installed such that the rubber segments lay with the ground.

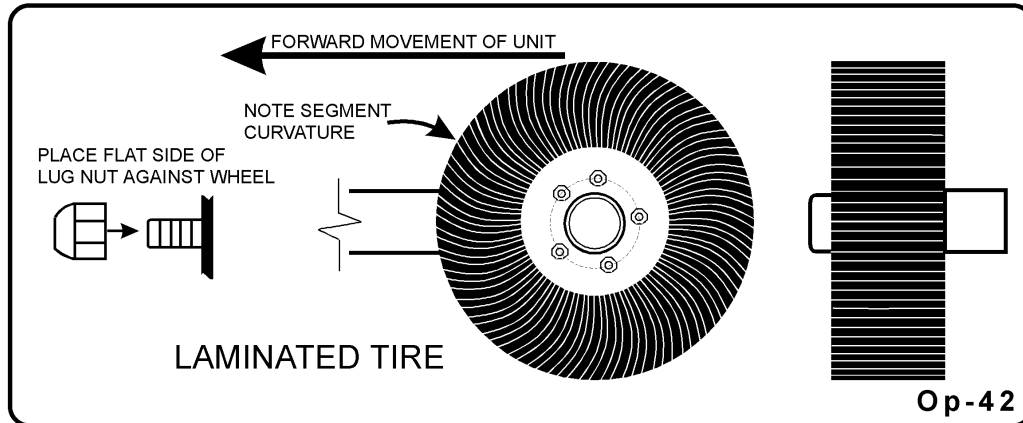

**Foam Filled used Airplane Tires** are ideal for conditions where a puncture proof tire is needed and the mower is frequently transported between locations. *OPS-R-0035\_D*

### Tire Size and Matching requirements - Center Axle

Tire assemblies when mounted on center axle duals should always be within limits listed.

Laminated Tires - Maximum difference between tire diameters on a center axle should be 1/2 inch or less.

Foam Filled Airplane Tires - Maximum difference between tire diameters on a center axle should be 1 inch or less.

When replacing a tire assembly on center axle always check diameters to make sure tires fall within allowed range for maximum tire and wheel life. It may be necessary to move one or more tires from wing axles to remain within size limit.

### 14.2 Transporting on Public Roadways

Extreme caution should be used when transporting the tractor and mower on public roadways. The tractor must be equipped with all required safety warning features including a SMV emblem and flashing warning lights to alert drivers of the tractor's presence. Remember that roadways are primarily designed for automotive drivers and most drivers will not be looking out for you, therefore, you must look out for them. Check your side view mirrors frequently and remember that vehicles will approach quickly because of the tractor's slower speed. Be extremely cautious when the piece of equipment that you are towing is wider than the tractor tire width and/or extends beyond your lane of the road.

Make sure that a proper size safety tow chain is secured between the tractor, flex arm and mower before entering a public road. Secure the center section at a safe transport height by placing additional stroke control spacers on the center axle cylinder and then lower the mower. Secure the mower wings in the raised position with the transport lock pins. *OPS-R-0036\_E*

# OPERATION

## **WARNING**

Only tow the Implement behind a properly sized and equipped Tractor which exceeds the weight of the Implement by at least 20%. DO NOT tow the Implement behind a truck or other type of vehicle. Never tow the Implement and another Implement connected in tandem. Never tow the Implement at speeds over 20 MPH. (STI-06)



## **DANGER**

Never allow children or other persons to ride on the Tractor or Implement. Falling off can result in serious injury or death. (SG-10)



## **WARNING**

Make certain that the "Slow Moving Vehicle" (SMV) sign is installed in such a way as to be clearly visible and legible. When transporting the Equipment use the Tractor flashing warning lights and follow all local traffic regulations. (SG-6)

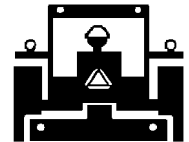

OPERATION

The SMV (Slow-Moving Vehicle) emblem is universal symbol used to alert drivers of the presence of equipment traveling on roadways at a slow speed. SMV signs are a triangular bright orange with reflective red trim for both easy day and night visibility. Make sure the SMV sign is clean and visible from the rear of the unit before transporting the tractor and implement on a public roadway. Replace the SMV emblem if faded, damaged, or no longer reflective. OPS-U- 0020



Make sure that all tractor flashing warning lights, headlights, and brake/tail lights are functioning properly before proceeding onto public roads. While newer model tractors have plenty of lighting to provide warning signals and operating lighting, most older models are only equipped with operating lights. Consult an authorized tractor dealer for lighting kits and modifications available to upgrade the lighting on older tractor models. OPS-U- 0021



# OPERATION

## OPERATION

When operating on public roads, have consideration for other road users. Pull to the side of the road occasionally to allow all following traffic to pass. Do not exceed the legal speed limit set in your country for agricultural tractors. Always stay alert when transporting the tractor and implement on public roads. Use caution and reduce speed if other vehicles or pedestrians are in the area. *OPS-U-0022*



Reduce speed before turning or applying the brakes. Ensure that both brake pedals are locked together when operating on public roads. *OPS-U-0023*

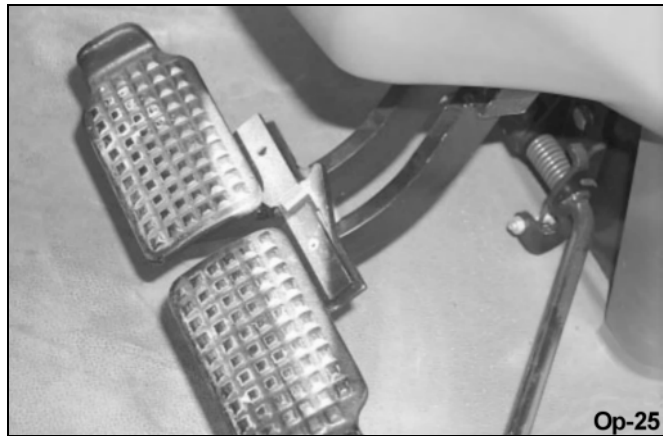



# OPERATION

## **14.3 Hauling the Tractor and Implement**

Before transporting a loaded tractor and implement, measure the height and width dimensions and gross weight of the complete loaded unit. Ensure that the load will be in compliance with the legal limits set for the areas that will be traveled through

Use adequately sized and rated trailers and equipment to transport the tractor and implement. Consult an authorized dealer to determine the proper equipment required. Using adequately sized chains, heavy duty straps, cables and/or binders, securely tie down both the front and rear of the tractor utilizing the proper tie down locations as specified by the tractor manufacturer.

Arrange the chains so that when tightened, the chains are pulling downward and against themselves. Carefully tighten the securing chains or other fasteners using boomers or binders to apply maximum tension. Use extreme care when attaching and removing the securing devices as the extreme tension involved when released has the potential to inflict serious injury.

While hauling the tractor and implement, make occasional stops to check that the tractor and implement have not moved or shifted and that the securing chains have maintained tension. If during transport a hard braking, sharp turning, or swerving action was performed, stop at the next safe location to inspect the security of the load.

# OPERATION

## 15. TROUBLE SHOOTING GUIDE

<b>Problem</b>	<b>Possible Cause</b>	<b>Remedy</b>
Excessive Vibrations	Check Gearbox bolts. Check for loose nuts on Blade holder and Blades Check for bent output shaft. If shaft is bent oil will normally leak from the bottom seal. Check to see if blades are free swinging. Check for even wear on each blade tip. Were both blades changed at the same time? Blade Broken. Blade carrier bent. Blade hub not properly seated on shaft New Blade or bolts matched	Tighten if loose. Tighten if loose.  Replace shaft if bent.  Free blades so they swing  Weigh blades. Weight should be within 1 oz. Always replace both blades  Replace blades, in sets. Replace carrier. Remove hub, check tapered spline shaft, clean and replace. Replace blades or bolts in sets
	Drivelines not phased correctly. Implement & tractor yokes must be in line.	Replace Drivelines.
Gearbox Overheating	Low on lubricant. Improper type lubricant. Excessive trash build-up around gear box Bearing or gears set up improperly	Fill to level plug. Replace with EP80W-90. Remove trash.  Consult your dealer.
Gearbox Noisy	Rough gears. Worn bearing.	Run in or change gears. Replace bearing
Gear Box Leaking	Damaged oil seal Bent shaft. Shaft rough in oil seal area. Oil seal installed wrong. Oil seal not sealing in the housing.	Replace Seal. Replace oil seal and shaft. Replace or repair shaft. Replace seal. Replace seal or use a sealant on OD of seal.
	Oil level too high. Sand hole in casting. Gasket damaged. Bolts loose.	Drain oil to proper level. Replace castings or gearbox. Replace gasket. Tighten bolts.
Clutch Slips Excessively	Clutch linings badly worn or plates warped. Too much power for clutch.	Repair clutch per maintenance section of manuals. Reduce ground speed and material intake.
	Oil on facings. Friction facings glazed.	Replace facings. Clean with emery cloth.

# OPERATION

Uneven Cut	Excessive ground speed. Blades worn, dull, or bent.	Reduce ground speed. Replace blades. (Refer to "Maintenance" section).
	Mower not level side to side. Improper height adjustment.	Adjust. (Refer to "Assembly" section) Adjust Mower height. (Refer to "Assembly" section)
	Low tractor tire pressure on one side.	Adjust tire pressure. (Refer to your tractor operator's manual)
	Turning too fast. Tractor tires push grass down.	Reduce ground speed when turning. Adjust your tractor wheel spacing. (Refer to "Operation" section)
	Damaged Mower pan.	Repair or replace as necessary.
Uncut Material	Excessive ground speed RPM too low	Reduce ground speed. Use full PTO speed. (Refer to your tractor operator's manual)
	Improper blade for direction of cut.	Install blades so rotation is correct.
Poor Shredding	Excessive ground speed.	Raise the front of Mower relative to the rear to hold and circulate material longer. (Refer to the "Operation Section-Setting the Mower-Setting Deck Height") Reduce ground speed.
	Cutting too high.	Lower cutting height. (Refer to the "Operation Section-Setting the Mower-Setting Deck Pitch")
Windrowing or Uneven Material Distribution	Material heavy and lush.	Raise the front of Mower relative to the rear. (Refer to the "Operation Section-Setting the Mower- Setting Deck Height")
	Excessive ground speed Conditions too wet.	Reduce ground speed. Wait for conditions to dry. Reduce ground speed.





# **MAINTENANCE SECTION**

Maintenance Section 5-1

# MAINTENANCE

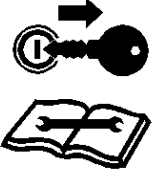
MAINTENANCE

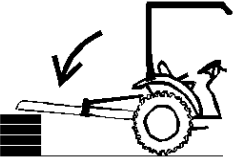
## HAZARDS WITH MAINTENANCE OF IMPLEMENT

				
Stop engine remove key before conducting maintenance	Entanglement hazard Do Not approach or touch a rotating PTO driveshaft	Block up implement before servicing Use large blocks on soft or wet soil	Crushing injury wing falling. Engage wing locks	Inspect Blades for damage or cracks

**⚠ WARNING** AVOID SERIOUS INJURY OR DEATH FROM COMPONENT FAILURE BY KEEPING IMPLEMENT IN GOOD OPERATING CONDITION IN PERFORMING PROPER SERVICE, REPAIRS AND MAINTENANCE.

### BEFORE PERFORMING SERVICE, REPAIRS AND MAINTENANCE ON THE IMPLEMENT:

#### SECURE EQUIPMENT FOR SERVICE

#### BLOCK OUT POTENTIAL ENERGY HAZARDS; Rotating Parts, Raised Components, Hydraulic Pressure.

- **STOP ENGINE AND PTO**, engage parking brake, lower implement, allow all moving parts to stop and remove key before dismounting from tractor.
- **PLACE** implement on ground or securely block up raised equipment. Use large blocks on soft or wet soil.
- **SECURELY LATCH** and **LOCK** raised implement wings
- **BLOCK UP IMPLEMENT TONGUE** with large blocks and tongue jack. **DO NOT** crawl or work under implement supported only by tongue jack.
- **PUSH** and **PULL** Remote Hydraulic Cylinder lever to relieve hydraulic pressure.
- **DISCONNECT IMPLEMENT** Hydraulic **HOSES** from tractor
- **DISCONNECT IMPLEMENT** driveline from tractor **PTO SHAFT**.

#### WEAR SAFETY GLASSES, PROTECTIVE GLOVES and follow SAFETY PROCEDURES when performing service, repairs and maintenance on the implement:

- Always **WEAR** protective **GLOVES** when handling blades, knives, cutting edges or worn component with sharp edges.
- Always **WEAR GLOVES** and **SAFETY GLASSES** when servicing hot components
- **AVOID CONTACT** with hot hydraulic oil tanks, pumps, motors, valves and hose connection surfaces.
- **SECURELY** support or **BLOCK UP** raised implement, framework and lifted components before working underneath equipment.
- **STOP** any implement movements and **SHUT-OFF TRACTOR** engine before doing any work procedures.
- **USE** ladder or raised stands to reach high equipment areas inaccessible from ground.
- **ENSURE** good footing by standing on solid flat surfaces when getting on implement to perform work.
- **FOLLOW** manufacturer's instructions in handling oils, solvents, cleansers, and other chemical agents.
- **DO NOT** change any factory-set hydraulic calibrations to avoid component or equipment failures.
- **DO NOT** modify or alter implement, functions or components.
- **DO NOT WELD** or repair rotating mower components. These may cause vibrations and component failures being thrown from mower.

#### PERFORM SERVICE, REPAIRS, LUBRICATION AND MAINTENANCE OUTLINED IN IMPLEMENT MAINTENANCE SECTION:

- **INSPECT** for loose fasteners, worn or broken parts, leaky or loose fittings, missing or broken cotter keys and washers on pins, and all moving parts for wear.
- **REPLACE** any worn or broken parts with authorized service parts.
- **LUBRICATE** unit as specified by lubrication schedule
- **NEVER** lubricate, adjust or remove material while it is running or in motion.
- **TORQUE** all bolts and nuts as specified.

#### BLADE INSPECTION:

- **REPLACE** bent, damage, cracked or broken blades immediately with new blades.
- **AVOID** blade failures and thrown broken blades. **DO NOT** straighten, weld, or weld hard-facing blades.

#### SAFETY SHIELDS, GUARDS AND SAFETY DEVICES INSPECTION:

- **KEEP** all Deflectors, Chain Guards, Steel Guards, Gearbox Shields, and PTO integral shields, Bands, Side Skirts and Skid Shoes in place and in good condition.
- **REPLACE** any missing, broken or worn safety shields, guards and safety devices.
- Engine Exhaust, some of its constituents, and certain vehicle components contain or emit chemicals known to the state of California to cause cancer, birth defects or other reproductive harm.
- Battery posts, terminals and related accessories contain lead and lead compounds, chemicals known to the state of California to cause cancer, birth defects or other reproductive harm. **PN HM02**

# MAINTENANCE

## PARTS INFORMATION

### PARTS INFORMATION

Bush Hog mowers use balanced and matched system components for blade carriers, blades, cuttershafts, knives, knife hangers, rollers, drivetrain components, and bearings. These parts are made and tested to Bush Hog specifications. Non-genuine "will fit" parts do not consistently meet these specifications. The use of "will fit" parts may reduce mower performance, void warranties, and present a safety hazard. Use genuine Bush Hog mower parts for economy and safety. (SPBH-1)

### SEE YOUR BUSH HOG DEALER

Before operating your Rotary Cutter, make sure it is properly lubricated and thoroughly inspected. Only a minimum of time and effort is required to regularly lubricate and maintain this machine to provide long life and trouble free operation.



Always disengage the PTO before raising the Rotary Cutter for transporting or making adjustments.

**NOTE:** *Some guards and shields have been removed from the illustrations and pictures for instructional clarity. DO NOT operate implement with out all shields and guards in place and in good condition.*

## Lubrication

Do not let excess grease collect on or around parts, particularly when operating in sandy areas. The accompanying illustration shows lubrication points. The chart gives the frequency of lubrication in hours, based on normal operating conditions. Severe or unusual conditions may require more frequent lubrication.

Add EP80W-90 oil, if necessary, to bring oil level to check plug located on side of housing. Capacity of center and wing gearboxes is 3 quarts, 6 ozs (3L). Capacity of power divider gearbox is 1quart, 29 oz (1.8L). Use N.L.G.I #2 type grease for all locations designated with grease gun. Be sure to clean the fitting thoroughly before using grease gun. Failure to maintain proper lubrication will result in damage to U-joints, gearbox, and/or driveshaft.

# MAINTENANCE

MAINTENANCE

## MOWER GREASE & OIL POINTS

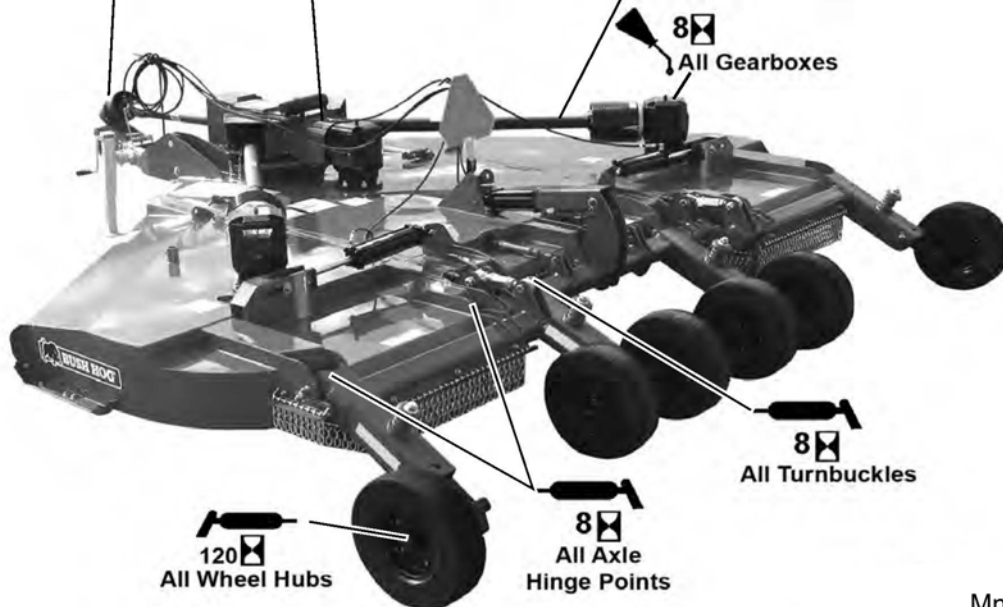
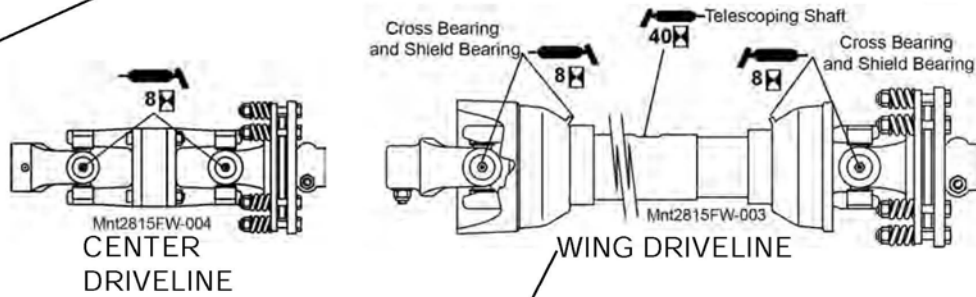
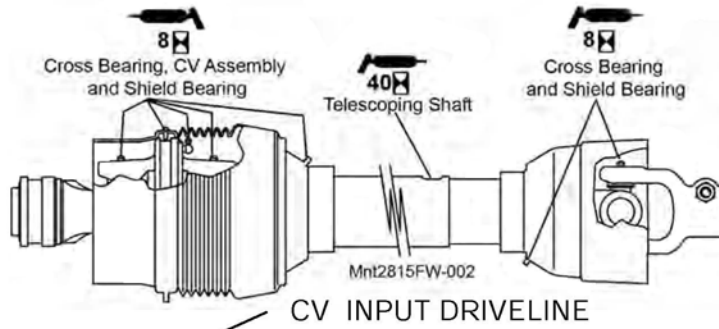

Mnt-R-0549

# MAINTENANCE

## CENTER & WING GEARBOXES

The Gearboxes have been filled with lubricant to the proper level prior to shipment. However, you should check the oil level before each use.

The gearbox should not require additional lubricant unless the box is cracked or a seal is leaking. Add EP80W-90 oil, if necessary, to bring oil level to check plug located on side of housing. (Oil level should be in the center of the Sight Glass). Capacity of center and wing gearboxes is 3 quarts, 6ozs. (3L). **FIGURE Mnt-R-0554.**

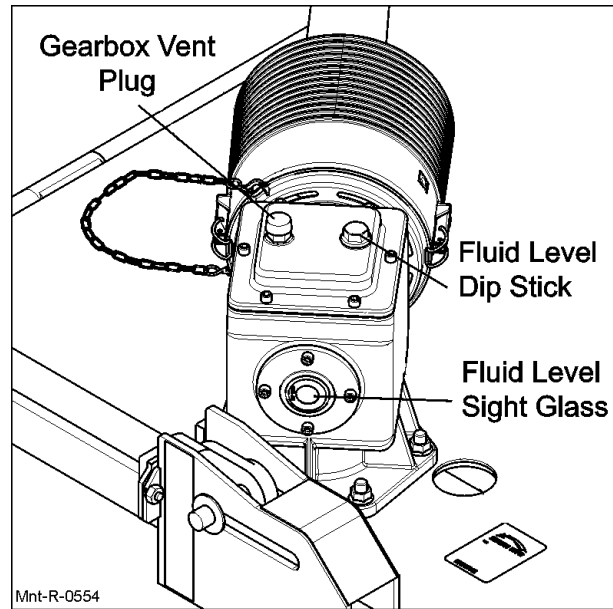

## DIVIDER GEARBOX

Add oil, if necessary, to bring oil level to check plug located on side of housing. **FIGURE Mnt-R-0551**



Do not over-fill. If gearboxes are filled above the Dipstick level, Pressure under working conditions may cause grease seals to leak.

Use EP80W-90 oil. Capacity of power divider gearbox is 1 quart, 29ozs. (1.8L).

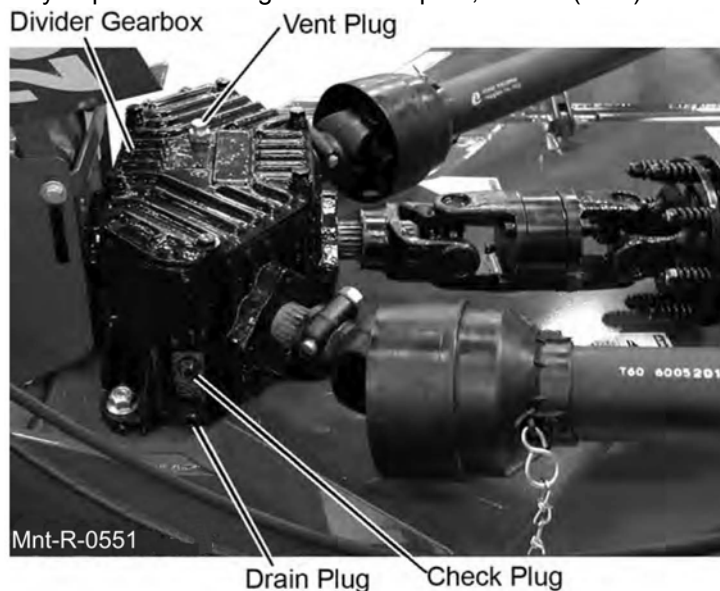



# MAINTENANCE

## MAIN CV DRIVELINE SAFETY SHIELD

To remove the outer CV cone, remove the locking screws from shield cone. Remove cone over yoke. Figure Mnt-R-0038 Remove bearing ring and remove the locking screws from inner shield cone. Figure Mnt-R-0038. Turn inner cone to assembly position and remove half shield. Remove bearing ring. FIGURE MNT-R-0038.

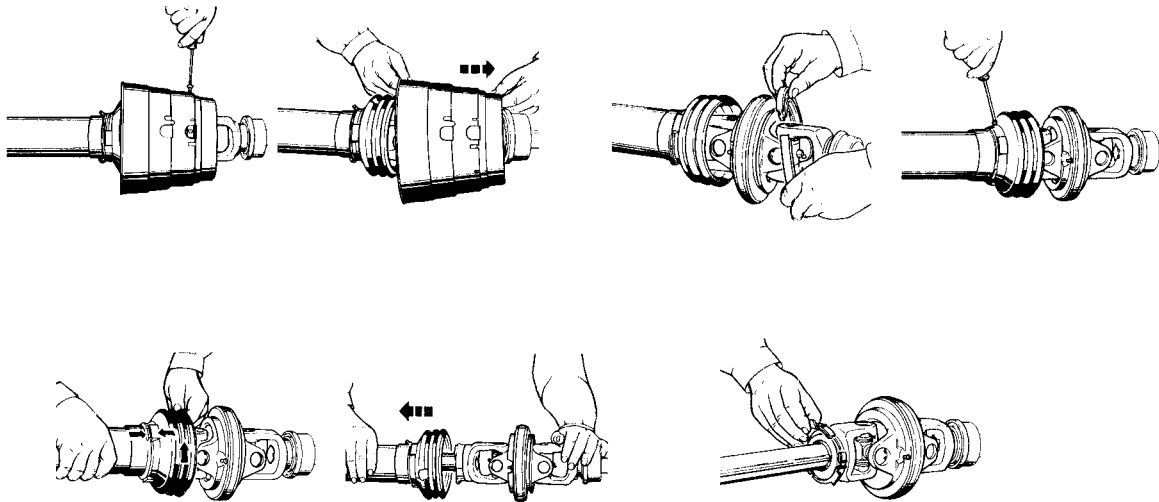

**Mnt-R-0038**

To assemble outer CV driveline, grease yoke groove and inner profile tube. Attach bearing ring on groove with recesses facing profile tube. FIGURE MNT-R-0039. Slide on half shield with cone. Turn cone until it engages correctly. FIGURE MNT-R-0039. Tighten locking screws. Grease bearing groove in double yoke. FIGURE MNT-R-0039. Insert bearing ring. Slide guard cone for double yoke over cam from the connecting end. Make sure holes for screws are visible. FIGURE MNT-R-0039. Tighten locking screws. FIGURE MNT-R-0039.

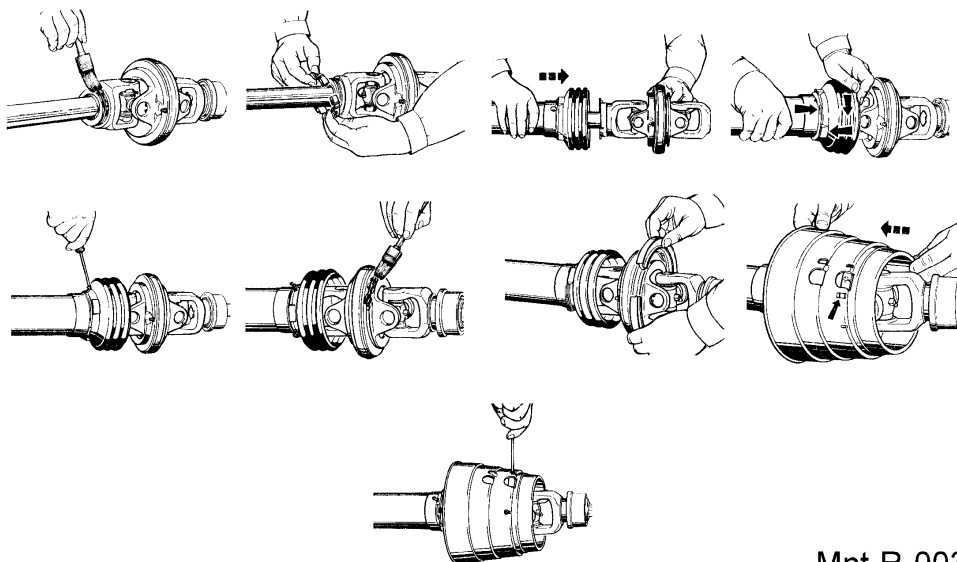

**Mnt-R-0039**

# MAINTENANCE

MAINTENANCE

## CAT IV WING DRIVELINE SHIELDS

To remove the main inner driveline shield, Remove the locking screws. Align the bearing tabs with the cone pockets. FIGURE Mnt-0026. Remove the half-guard and remove the bearing ring. FIGURE Mnt-R-0012.

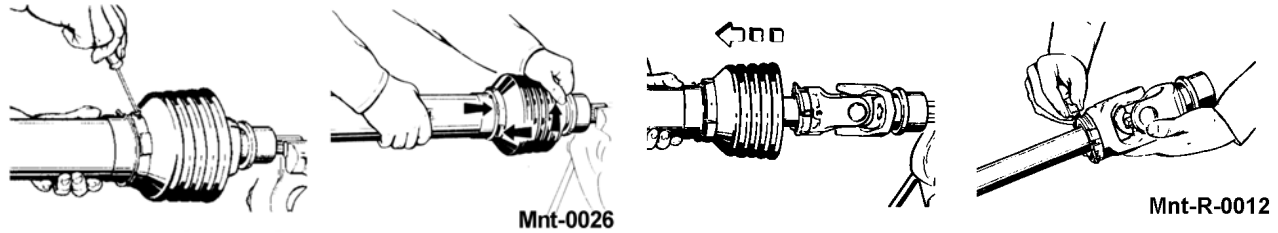

Inspect the driveline shield for worn areas or cracks. If the shield has any dents or cracks, replace the Shield. While the Shields are off, examine the Driveline for signs of abnormal wear, bent or twisted shafts, or cracks in the shafts or tubes. Check to see that the Drivelines telescope easily. If the Drivelines do not telescope properly or show signs of abnormal wear, the shaft should be repaired or replaced.

To assemble the main inner driveline shield, grease the yoke groove and inner profile tube. Attach the bearing ring in groove with recesses facing profile tube. FIGURE Mnt-0027. Slide on the half shield. Turn the cone until it engages correctly. Install locking screws. FIGURE Mnt-0028.

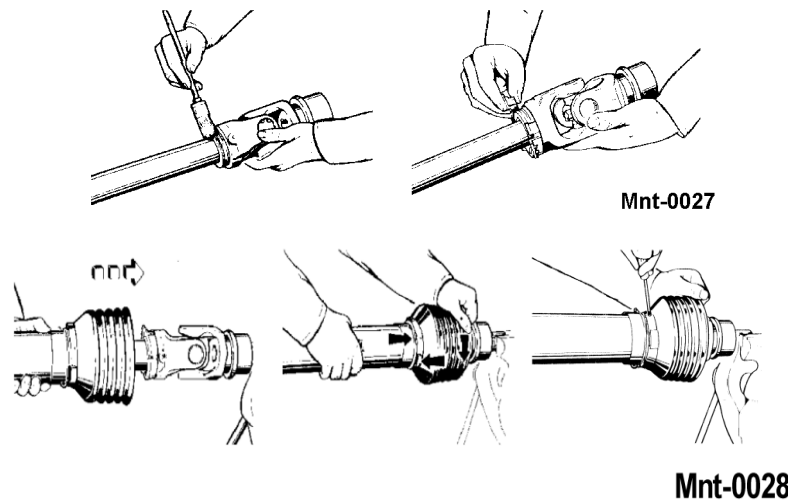

**IMPORTANT!** Check that Guard Missing decal on steel under inner guard and Rotating Driveline Decal are firmly affixed, undamaged and readable. If not,



**IMPORTANT:** Scan this QR Code with your smart phone to link to the ADMA Driveline Safety Manual for more information on the safe use of a driveline during normal operation and maintenance. Or type in your internet browser the following web address: [www.algqr.com/dme](http://www.algqr.com/dme) Ops-0009-MISC



# MAINTENANCE

## SEASONAL CLUTCH MAINTENANCE

It is important that the clutches slip when an obstacle or load heavier than the clutch setting is encountered. Therefore, if the machine sits outside longer than 30 days and is exposed to rain and/or humid air it is important to make sure that the clutch lining plates are not rusted/frozen together. Before using the cutter use the following procedure to make sure the clutch will slip and give the overload protection required.

1. Loosen eight nut retaining clutch springs 1/3 turn or until spring can be turned with fingers.
2. With Tractor at idle speed, engage tractor PTO drive for 2-3 seconds. Clutch should slip without turning blades. If clutch does not slip, contact your authorized Bush Hog dealer.
3. Retighten nuts to within 1/64" of original position. Initial spring lengths are shown in **Figure Mnt-R-0476**.

**Important**

Failure to retighten spring nuts to original position may cause damage to implement and/or tractor due to improper slip clutch torque setting.

**Important**

Do not over-tighten nut and cause spring to become solid as this will cause shaft to fail.

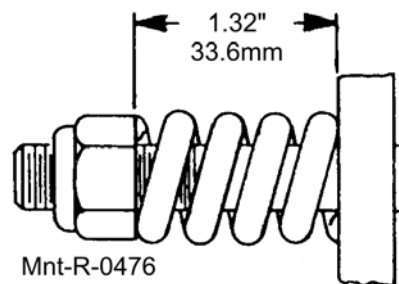

## SLIP CLUTCH ADJUSTMENT

The slip clutch is factory present to the correct torque for protecting implement and tractor. Periodic adjustment is recommend. Should adjustment be needed, first check to be sure all spring lengths are the same. Initial spring lengths are shown in **Figure Mnt-R-0476**. If necessary, adjust nut on an spring that is unequal. Adjust all eight spring retaining nuts 1/3 of a turn (2 flats on a nut) and check clutch slippage. If further adjustment is necessary, do so in 1/3 turn increments. Adjust only to provide sufficient torque to prevent slippage under normal conditions. Occasional slippage is normal for drivetrain protection. If satisfactory results cannot be obtained consult your Bush Hog dealer.

# MAINTENANCE

## BLADE SERVICING

Inspect blades before each use to determine that they are properly installed and in good condition. Replace any blade that is bent, excessively nicked, worn, or has any other damage. Small nicks can be ground out when sharpening.

### **WARNING**

Use only original equipment blades on this cutter. They are made of special heat-treated alloy steel. Substitute blades may not meet specifications and may fail in a hazardous manner that could cause injury.

### **DANGER**

Replace bent or broken blade with new blades. NEVER ATTEMPT TO STRAIGHTEN OR WELD ON BLADES SINCE THIS WILL LIKELY CRACK OR OTHERWISE DAMAGE THE BLADE WITH SUBSEQUENT FAILURE AND POSSIBLE SERIOUS INJURY FROM THROWN BLADES. (SGM-10)

- Manually wiggle the blade carriers to check for any looseness.
- Retighten any loose parts.
- Recheck torque every 50 hours.

### **Important**

Operating with loose blade hardware will damage the blade holder and blades. Whenever the blades have been removed or replaced, the hardware must be retightened after the first eight hours of operation. On new units check blade hardware and the blade nut torque after first 8 hours.

### **Important**

Operating with loose blade holder will damage the blade holder and output shaft, two initial tightenings are required. Retighten after one hour and again after the day of operation. In severe cutting conditions or commercial use, a daily inspection is required.

### **Important**

To help prevent structural damage caused by loose hardware, tighten gear case hardware as specified. Check torque after first 8 hours of use and every 50 hours thereafter.

### **DANGER**

Inspect Blades daily for abnormal wear. If Blades have a notch worn into the leading edge at the lower bend more than a 1/2" DEEP (due to running in gravel and/or the ground), REPLACE BOTH BLADES ON THAT CARRIER IMMEDIATELY. Failure to replace such abnormally worn blades may lead to catastrophic failure of the blade and ejection of the broken part with tremendous force which may cause bodily injury or death.

**NOTE:** Replace Blades in pairs after no more than 1/2" notch wear. Use only genuine Bush Hog replacement blades!

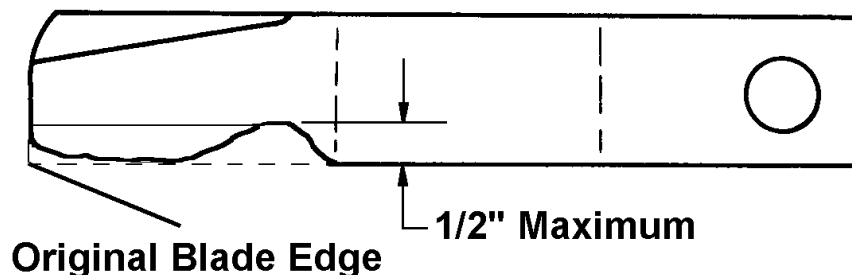

Mnt-R-0034

# MAINTENANCE

## BLADE SHARPENING

Always sharpen both blades at same time to maintain balance. Follow original sharpening pattern as shown in FIGURE Mnt-R-0008. Always sharpen blades by grinding. DO NOT heat and pound out edge. Do not sharpen blade to a razor edge, but leave a 1/16" blunt edge. Do not sharpen back side of blade.

IMPORTANT: When sharpening blades, grind each blade the same amount to maintain balance. The difference in blade weights should not exceed 1 ounce. Unbalanced blades will cause excessive vibration which can damage gear box bearings. Vibration may also cause structural cracks in cutter housing.

### WARNING

Never work under equipment supported by a hydraulic device because it may drop if the control is actuated (even with the engine stopped) or in the event of hose failure, etc. Always use a secure support for equipment which must be serviced while in the raised position.

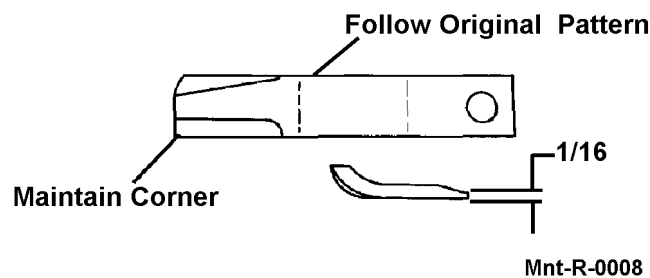

NOTE: Replace Blades in pairs after no more than 1/2" notch wear!

## BLADE REMOVAL

It is not necessary to remove the complete blade holder assembly to replace the blades. Blade bolts are accessible through a hole in the top of the cutter deck. Always replace both blades on a spindle using two blades having the same weight. Use only genuine Bush Hog replacement blades.

1. Remove nuts from blade bolts. A blade nut socket (Part No. 6432) can be bought at your Bush Hog dealer and used with an adjustable wrench (not supplied) to remove blade nut. Blade nut can also be removed with a 1-11/16" socket.
2. Inspect blade bolt shoulder for wear. Replace if necessary.
3. Assemble new blades to blade holder using blade bolts, nuts and lockwashers. Refer to BLADE ROTATION DIAGRAM for blade placement. Tighten nuts to 450ft./lbs if lubed, 600 ft./lbs. if dry. Strike blade bolt head with heavy hammer to seat, then retighten.
4. Check to be sure blades swing 360° freely. If blades will not swing freely, remove, locate problem, and repair. Operating cutter when blades will not swing freely will cause excessive vibration, damaging implement.

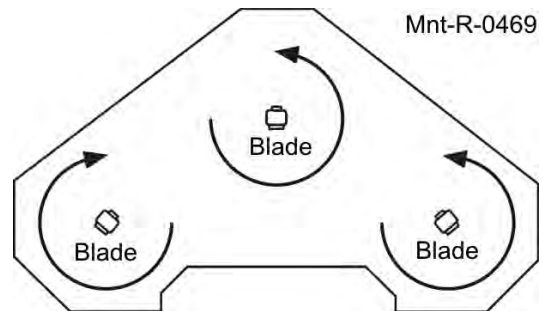
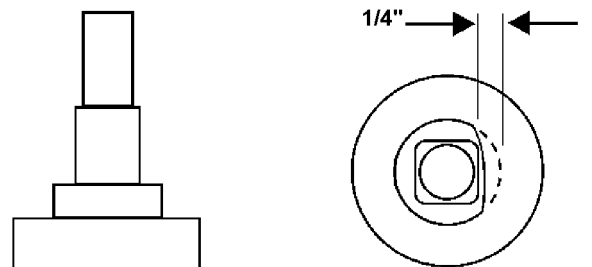

# MAINTENANCE



Avoid personal injury. Blade and/or blade carrier removal should be done only with the tractor engine shut off, key removed, in neutral, parking brake on, PTO disengaged, and the cutter blocked in the raised position.

## Blade Bolt Inspection

Inspect Blade Bolt Head daily for wear as followed:

### Excessive Blade Bolt Wear

**Cause:** Blade Bolt contacts a foreign or solid object while Blade is in motion.

**Remedy:** Inspect the area before mowing to determine where the foreign objects are located and place visible hazard markers to identify the areas where immovable foreign objects exist, and avoid hitting the objects.

### Notches and Gouges

**Cause:** Blade Bolt contacting foreign objects.

**Remedy:** Inspect area to be mowed and remove foreign objects that could cause damage to the blade bolt.

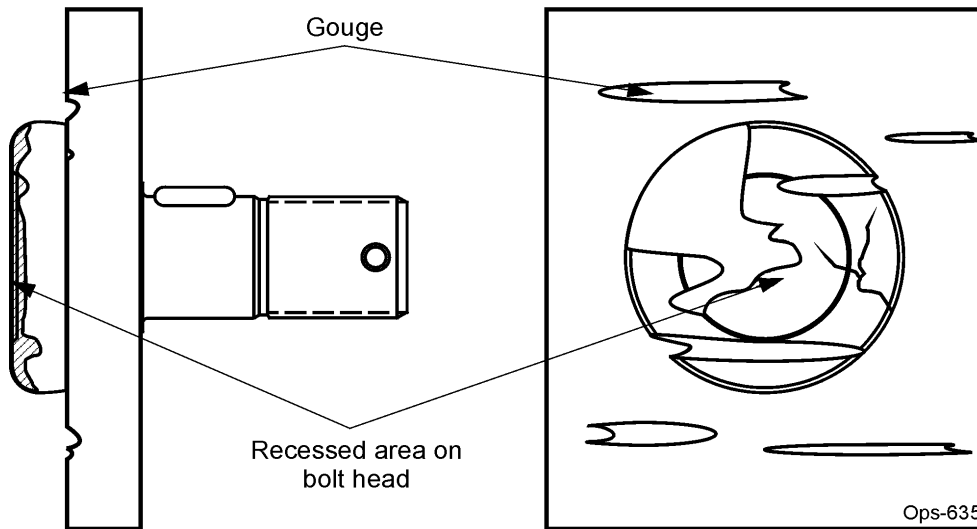

Inspect the Blade Bolt Heads daily for abnormal wear. REPLACE BOTH BLADE BOLTS on the Blades IMMEDIATELY if either blade bolts has:

- Visible cracks or
- If the recessed area on blade bolt is worn off or
- If Blade Bolt has gouges or chipped areas.

Failure to replace abnormally worn blade bolts may lead to catastrophic failure of the blades and ejection of the broken part which may cause serious bodily injury or death.

## BLADE HOLDER ASSEMBLY

### Blade Removal

1. Remove cotter pin and blade holder assembly retaining nut and washer. Retaining nut can be removed or tightened with a 1-3/16" socket.
2. Wearing heavy gloves, grasp blade holder and pull off shaft. If stuck, align blade bolt with access hole in top of cutter deck. Using hammer and a piece of pipe, strike blade bar. Repeat until blade holder comes off. Care should be taken not to damage blade bolt threads.

# MAINTENANCE

## Installation

1. Align the blade holder so the cotter pin hole is positioned 90° to the blade bar (for ease of installing the cotter pin).
2. Place blade holder assembly, washer, and retaining nut on lower shaft. Torque nut to 450 ft. lbs. Strike the head of the blade bolt with a sledge hammer on one side and then the other. This will help seal the pan to the gearbox output shaft. Always recheck the torque of the nut after using the sledge hammer.
3. Install cotter pin. It may be necessary to tighten nut slightly to install cotter pin. Always tighten slightly more so that the cotter pin may be installed. Do not "Back Off" on the nut to align slots with hole.

**NOTE:** After a few hours of operation always recheck blade carrier retaining nut torque.

### Important

Operating the mower with a loose blade pan or holder can damage the taper connection on the gearbox output shaft. To ensure proper seating between the blade holder and output shaft check and tighten the retaining nut after the first day of operation. Recheck the blade carrier attachment each morning before operating. Grasp the carrier firmly with both hands and try to push and pull the carrier with one hand while pulling and pushing with the other hand to try to rock or oscillate the blade carrier. If the carrier is loose retighten the retaining nut before operating the mower.

### WARNING

Avoid personal injury. Do not work under cutter without support blocks to keep frame from falling.

## WHEEL HUB ASSEMBLY

The Wheel Hub Assemblies need to be lubricated every 120 hours. **FIGURE MntP-R-0032.**



## AXLE ARM SPRING

Axle Arm Spring Adjustment should be maintained at a dimension of 5" equally on all axle arms from the top of the axle arm to the top of the Spring Cap. (Always make sure at least two threads of the bolt extend past the top of the locknut.) **Figure MntP-R-0275**

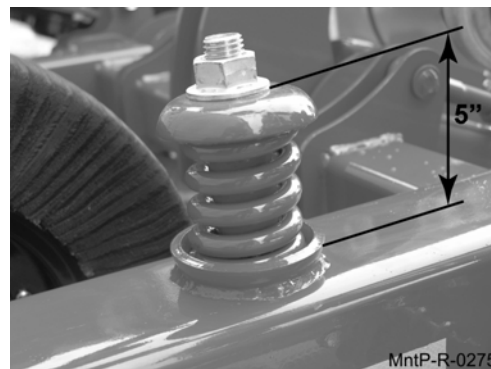

# MAINTENANCE

MAINTENANCE

## TIRES AND WHEELS

Before working on any tires and wheels make certain the Cutter is jacked up high enough and securely supported. When installing laminated or airplane tires, be sure the flat side of the lug nut is against the Wheel.

When installing Sectional Tires and Wheels note the direction of travel and the curvature of rubber segments in the tire (See Assembly Section). Do not exceed 15 M.P.H. on Sectional Tires. When removing Airplane Tires, let all of the air out of the tire before removing lug nuts or wheel bolts or nuts. Remove valve core to make certain that there is no air pressure left in tube before separating wheel halves to dismount tires. DO NOT LOOSEN WHEEL CLAMP BOLTS BEFORE PRESSURE IS REMOVED FROM TUBE AND TIRE TO PREVENT EXPLOSIVE SEPARATION OF WHEEL HALVES WITH POSSIBLE SERIOUS BODILY INJURY. Do not exceed 15 M.P.H. on Airplane or Rib Implement Tires.

Maximum airplane tire inflation pressure is 50 PSI, minimum inflation pressure is 20 PSI.

## TONGUE

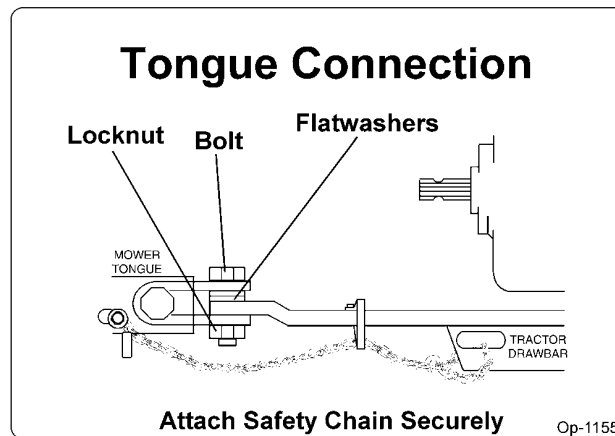

The Tongue Hitch Pins attach the Tongue to the Center Section and should be checked for signs of wear or cracking. Replace as needed. The Drawbar 1" Bolt fastens the mower to the tractor Drawbar. When the mower is unhitched and this 1" Bolt is removed, examine for signs of cracking or wear. Replace the Drawbar 1" Bolt at first sign of either problem. FIGURE Op-1155



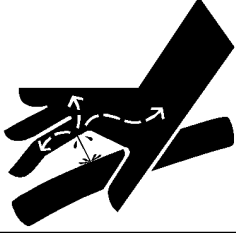

# MAINTENANCE

## HIGH PRESSURE OIL LEAK HAZARD

		
High pressure oil penetrating skin	High pressure oil eroding skin	Using cardboard to check for oil leaks

**⚠ DANGER** TO AVOID SERIOUS INJURY OR DEATH FROM HIGH PRESSURE HYDRAULIC OIL LEAKS PENETRATING SKIN:

- **DO NOT OPERATE** equipment with oil or fuel leaks.
- **KEEP** all hydraulic hoses, lines and connections in **GOOD CONDITION** and **TIGHT** before applying system pressure.
- **RELIEVE HYDRAULIC PRESSURE** before disconnecting lines or working on the system.
- **REMOVE** and replace hose if you suspect it leaks. Have dealer test it for leaks.

**HIGH PRESSURE FLUID LEAKS CAN BE INVISIBLE.**

**WHEN CHECKING FOR HYDRAULIC LEAKS AND WORKING AROUND HYDRAULIC SYSTEMS:**

- **ALWAYS WEAR** safety glasses and impenetrable gloves.
- **USE** paper or cardboard to search for leaks.
- **DO NOT USE** hands or body parts to search for leak.
- **KEEP** hands and body **AWAY** from pin holes and nozzles ejecting hydraulic fluid.
- Hydraulic fluid may cause gangrene if not surgically removed immediately by a doctor familiar with this form of injury.

*PN HP01*

## HYDRAULIC HOSES

Replace pinched and broken Hydraulic Hoses at once. Tighten any Hydraulic Fitting with fluid leaking from it. If fluid still leaks, loosen the fitting, apply a pipe thread compound to the threads and tighten. Care must be exercised when tightening Hydraulic Fittings. Too much tightening can cause the fittings to crack and require replacement fittings.

Although a small amount of oil will be present from bleeding at all Hydraulic Fittings, significant amounts of oil leaking around the Breather Plug on the Cylinder indicates that the seal in the Cylinder is worn out. Replace the seals in the Cylinder immediately before the Cylinder is damaged or too much hydraulic fluid is lost.

### MAXIMUM ALLOWABLE OPERATING OIL TEMPERATURE

Do not operate this implement if the tractor hydraulic oil temperature exceeds 200°F

# MAINTENANCE

## Flex Wing Hydraulic Cylinder Replacement Instructions

### Implement Cylinders Removal and Replacement

Follow these Steps:

1. Clear the area of all personnel before lowering the wings.
2. From the tractor seat with your seat belt fastened around you, Lower the implement wings to the ground. Do Not attempt to replace the cylinder with the wings in the raised position.
3. Shut off the tractor, engage the parking brake, place the tractor transmission in the park position, and remove the key before dismounting.
4. Block up the center and wing sections with blocks or jack stands
5. Release all oil pressure from the circuit by moving the valve controls handles back and forward.
6. Remove the Implement Input Driveline from the tractor PTO shaft.
7. Remove the hydraulic hoses from tractor quick disconnects.
8. Wear Safety Glass and impenetrable gloves when working with hydraulic hoses and fittings.
9. Check to see that the cylinder is not under pressure by moving the cylinder pins by hand. The pins should be loose. If the cylinder pins are in a bind and can not be moved the cylinder maybe under pressure. Make sure the implement decks and axles are supported by blocks and then carefully remove one of the cylinder pins.
  - Do Not allow any one or any part of your body to be underneath the implement wing.
  - Do not loosen the hydraulic connections to the cylinder until all pressure has been relieved.
10. Slowly loosen the hydraulic hose connection to the cylinder.
11. Remove the other cylinder pin and remove the cylinder. The cylinder maybe heavy, use proper lifting techniques to lift and handle the cylinder and if needed get assistance in lifting from another person.
12. Measure the distance between the cylinder pin holes and extend the new cylinder to that length before installing.
13. Install the new cylinder in place and install both cylinder pins and retaining clips in place.
14. Reconnect hydraulic hose(s) to the cylinder, and tighten the fittings.
  - Wing cylinder has a special adaptor with a small hole drilled in it to control the lowering speed on the wing. Make sure this adaptor is installed. Without this adaptor, the wing can fall rapidly.
15. Reconnect the implement hoses to the tractor.
16. Get into the Tractor seat and fasten your seat belt. Clear the area of all persons before attempting to raise the wing. From the tractor seat, start the tractor and operate the control valve to raise the wing.
17. Look for sign of oil leak. If an oil leak exists, shut the tractor down and remove all oil pressure in the lines by moving the valve control handles back and forward.
  - Retighten any lose fittings or connections.
  - If a hose is leaking, replace the hose with a new hose.
18. If there are no leaks raise and lower the wing completely at least three full cycles to remove any air trapped in the circuit.
19. Check the hydraulic reservoir of the tractor to ensure there is sufficient oil.
20. If the wing is to remain in the raised position attached the wing transport lock pins.

# MAINTENANCE

## SKID SHOES

Skid shoes are made of carbon steel to reduce wear and increase service life. Premature wear can be caused by the mower Center or Wing sections being set too low which allows the Wing Skid Shoes to drag on the ground. Dragging the Skid Shoes on the ground or running the Skid Shoes into solid objects can contribute to early frame failure on the mower. Replace worn Skid Shoes as required.

## STORAGE

Your rotary cutter represents an investment from which you should get the greatest possible benefit. Therefore, when the season is over, the cutter should be thoroughly checked and prepared for storage so that a minimum amount of work will be required to put it back into operation for the next season. The following are suggested storage procedures:

1. Thoroughly clean the cutter.
2. Lubricate the cutter as covered in Maintenance Section.
3. Tighten all bolts and pins to the recommended torque.
4. Check the cutter for worn or damaged parts. Make replacements immediately.
5. Store the cutter in a clean, dry place with the cutter housing resting on blocks.
6. Use spray touch-up enamel where necessary to prevent rust and maintain the appearance of the cutter.

# MAINTENANCE

MAINTENANCE

## PROPER TORQUE FOR FASTENERS

The chart lists the correct tightening torque for fasteners. When bolts are to be tightened or replaced, refer to this chart to determine the grade of bolts and the proper torque except when specific torque values are assigned in manual text.

RECOMMENDED TORQUE IN FOOT POUNDS UNLESS OTHERWISE STATED IN THE MANUAL \*

NOTE: These values apply to fasteners as received from supplier, dry or when lubricated with normal engine oil. They do not apply if special graphited or molydisulphide greases or other extreme pressure lubricants are used. This applies to both UNF fine and UNC coarse threads.

### TORQUE SPECIFICATIONS

Proper torque for American fasteners.  
Recommended Torque in Foot Pounds (Newton Meters).\*

#### AMERICAN

Bolt Head Markings



SAE Grade 2  
(No Dashes)



SAE Grade 5  
(3 Dashes)

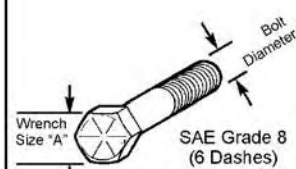

SAE Grade 8  
(6 Dashes)



All Capscrews  
SAE Grade 8

WRENCH SIZE (IN.) "A"	BOLT DIAMETER (IN.) "B" AND THREAD SIZE	SAE GRADE 2	SAE GRADE 5	SAE GRADE 8
7/16	1/4 - 20 UNC	6 (7)	8 (11)	12 (16)
7/16	1/4 - 28 UNF	6 (8)	10 (13)	14 (18)
1/2	5/16 - 18 UNC	11 (15)	17 (23)	25 (33)
1/2	5/16 - 24 UNF	13 (17)	19 (26)	27 (37)
9/16	3/8 - 16 UNC	20 (27)	31 (42)	44 (60)
9/16	3/8 - 24 UNF	23 (31)	35 (47)	49 (66)
5/8	7/16 - 14 UNC	32 (43)	49 (66)	70 (95)
5/8	7/16 - 20 UNF	36 (49)	55 (75)	78 (106)
3/4	1/2 - 13 UNC	49 (66)	76 (103)	106 (144)
3/4	1/2 - 20 UNF	55 (75)	85 (115)	120 (163)
7/8	9/16 - 12 UNC	70 (95)	109 (148)	153 (207)
7/8	9/16 - 18 UNF	79 (107)	122 (165)	172 (233)
15/16	5/8 - 11 UNC	97 (131)	150 (203)	212 (287)
15/16	5/8 - 18 UNF	110 (149)	170 (230)	240 (325)
1-1/8	3/4 - 10 UNC	144 (195)	266 (360)	376 (509)
1-1/8	3/4 - 16 UNF	192 (260)	297 (402)	420 (569)
1-5/16	7/8 - 9 UNC	166 (225)	430 (583)	606 (821)
1-5/16	7/8 - 14 UNF	184 (249)	474 (642)	668 (905)
1-1/2	1 - 8 UNC	250 (339)	644 (873)	909 (1232)
1-1/2	1 - 12 UNF	274 (371)	705 (955)	995 (1348)
1-1/2	1 - 14 UNF	280 (379)	721 (977)	1019 (1381)
1-11/16	1-1/8 - 7 UNC	354 (480)	795 (1077)	1288(1745)
1-11/16	1-1/8 - 12 UNF	397 (538)	890 (1206)	1444 (1957)
1-7/8	1-1/4 - 7 UNC	500 (678)	1120 (1518)	1817 (2462)
1-7/8	1-1/4 - 12 UNF	553 (749)	1241 (1682)	2013 (2728)
2-1/16	1-3/8 - 6 UNC	655 (887)	1470 (1992)	2382 (3228)
2-1/16	1-3/8 - 12 UNF	748 (1011)	1672 (2266)	2712 (3675)
2-1/4	1-1/2 - 6 UNC	870 (1179)	1950 (2642)	3161 (4283)
2-1/4	1-1/2 - 12 UNF	979 (1327)	2194 (2973)	3557 (4820)

#### METRIC

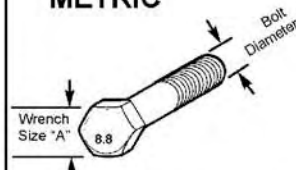

Wrench Size "A"

Bolt Diameter "B"

8.8

Numbers appearing on bolt heads indicate ASTM class.

\*Use 75% of the specified torque value for plated fasteners. Use 85% of the specified torque values for lubricated fasteners.

WRENCH SIZE (mm) "A"	BOLT DIA. (mm) "B"	ASTM 4.6	ASTM 8.8	ASTM 9.8	ASTM 10.9
6	5	1.8 (2.4)		5.1 (6.9)	6.5 (8.8)
10	6	3 (4)		8.7 (12)	11.1 (15)
13	8	7.3 (10)		21.1 (29)	27 (37)
16	10	14.5 (20)		42 (57)	53 (72)
18	12	25 (34)	74 (100)	73 (99)	93 (126)
21	14	40 (54)	116 (160)	116 (157)	148 (201)
24	16	62 (84)	167 (226)	181 (245)	230 (312)
30	20	122 (165)	325 (440)		449 (608)
33	22		443 (600)		611 (828)
36	24	211 (286)	563 (763)		778 (1054)
41	27		821 (1112)		1138 (1542)
46	30	418 (566)	1119 (1516)		1547 (2096)

Mnt-B-0005

# SEGURIDAD

# SEGURIDAD

**WARNING**

Rated Vertical: 3000 lbs  
Loads Side: 675 lbs

**TO AVOID SERIOUS INJURY:**

- Fully engage jack retaining pin.
- Adjust jack vertically.
- Torque positioning nut to 150 ft-lbs.
- DO NOT exceed rated loads.

**⚠ ADVERTENCIA**

**PARA EVITAR LESION SERIA:**

- Aplique completam ente el perno de retencion al gato.
- Ajuste el gato verticalmente.
- Apriete la tuerca a torsion de 150 p/lbs.
- NO exceda las cargas calculadas.

D762 SP

**▲ PELIGRO**

**RIESGO DE OBJETOS LANZADOS**

**PARA EVITAR LESION SERIA O MUERTE:**

NO OPERE si la Cubierta de Objetos Lanzados esta dañada o falta.

MANTENGA la Cubierta de Objetos Lanzados

D614 SP

**▲ DANGER**

**THROWN OBJECT HAZARD**

**TO AVOID SERIOUS INJURY OR DEATH:**

DO NOT OPERATE if Thrown Object Shielding is damaged or missing.

MAINTAIN Thrown Object Shielding

**▲ PELIGRO**

**RIESGO DE OBJETOS LANZADOS**

**PARA EVITAR LESION SERIA O MUERTE:**

NO OPERE si la Cubierta de Objetos Lanzados esta dañada o falta.

MANTENGA la Cubierta de Objetos Lanzados

D614 SP

<p><b>▲ PELIGRO</b></p> <p><b>Si no puede leer inglés: antes de poner en funcionamiento este equipo, solicite que alguien le traduzca los mensajes de seguridad o vaya al sitio web para consultar los mensajes de seguridad y las etiquetas ya traducidos.</b></p> <p>français: avant d'utiliser l'équipement, demandez à une personne de vous traduire les messages de sécurité ou allez sur le site Internet pour voir la traduction des autocollants et des messages de sécurité.</p> <p>El Manual del Operador Seguridad video</p> <p><a href="http://www.algqr.com/bvms">www.algqr.com/bvms</a></p>	<p><b>▲ DANGER</b></p> <p><b>Caso você não leia inglês: antes de operar o equipamento, peça para alguém traduzir as mensagens de segurança ou visite a web e obtenha tais mensagens ou os decalques traduzidos.</b></p> <p>français: avant d'utiliser l'équipement, demandez à une personne de vous traduire les messages de sécurité ou allez sur le site Internet pour voir la traduction des autocollants et des messages de sécurité.</p> <p>Manual de l'Opérateur</p> <p><a href="http://www.algqr.com/bmft">www.algqr.com/bmft</a></p>	<p><b>▲ PERIGO</b></p> <p><b>Caso você não leia inglês: antes de operar o equipamento, peça para alguém traduzir as mensagens de segurança ou visite a web e obtenha tais mensagens ou os decalques traduzidos.</b></p> <p>français: avant d'utiliser l'équipement, demandez à une personne de vous traduire les messages de sécurité ou allez sur le site Internet pour voir la traduction des autocollants et des messages de sécurité.</p> <p>Manual do Operador</p> <p><a href="http://www.algqr.com/bmp">www.algqr.com/bmp</a></p>	<p><b>▲ GEFAHR</b></p> <p><b>Falls Sie Deutsch nicht lesen können: Lassen Sie sich, bevor Sie das Gerät in Betrieb nehmen, die Sicherheitshinweise von einer geeigneten Person in Ihrer Sprache übersetzen. Oder suchen Sie auf unserer Website nach Übersetzungen von Schilderaufschriften und Sicherheitshinweisen.</b></p> <p>Benutzerhandbuch</p> <p><a href="http://www.algqr.com/bmg">www.algqr.com/bmg</a></p>
-----------------------------------------------------------------------------------------------------------------------------------------------------------------------------------------------------------------------------------------------------------------------------------------------------------------------------------------------------------------------------------------------------------------------------------------------------------------------------------------------------------------------------------------------------------------------------------------------------------	----------------------------------------------------------------------------------------------------------------------------------------------------------------------------------------------------------------------------------------------------------------------------------------------------------------------------------------------------------------------------------------------------------------------------------------------------------------------------------------------------------------------------------------------	-----------------------------------------------------------------------------------------------------------------------------------------------------------------------------------------------------------------------------------------------------------------------------------------------------------------------------------------------------------------------------------------------------------------------------------------------------------------------------------------------------------------------------------------	-----------------------------------------------------------------------------------------------------------------------------------------------------------------------------------------------------------------------------------------------------------------------------------------------------------------------------------------------------------------------------------------------------------------------

# SEGURIDAD

# SEGURIDAD

<p><b>⚠ ADVERTENCIA</b></p>	<p>Partes que no son auténticas pueden fallar catastróficamente.</p> <p><b>PARA EVITAR LESION SERIA O MUERTE:</b></p> <ul style="list-style-type: none"> <li>• Use SOLAMENTE las partes de reemplazo auténticas de BUSH HOG.</li> <li>• Partes que no son auténticas pueden fallar y causar condiciones peligrosas para el operador y personas presentes. Contacte a su distribuidor local o BUSH HOG sobre partes de reparo a:</li> </ul> <p>2501 Griffin Ave., Selma, AL 36701          Servicio al Cliente: 800-363-6096.          Correo Electrónico: <a href="mailto:contactus@bushhog.com">contactus@bushhog.com</a></p> 
<p><b>⚠ WARNING</b></p>	<p>Non-genuine parts can fail catastrophically.</p> <p><b>TO AVOID SERIOUS INJURY OR DEATH:</b></p> <ul style="list-style-type: none"> <li>• ONLY use genuine BUSH HOG replacement parts.</li> <li>• Non-genuine parts can fail creating hazardous conditions for operator and bystanders.</li> </ul> <p>Contact local dealer or BUSH HOG about repair parts at:</p> <p>2501 Griffin Ave., Selma, AL 36701          Customer Service: 800-363-6096.          Email: <a href="mailto:contactus@bushhog.com">contactus@bushhog.com</a></p> 
<p><b>IMPORTANT</b></p>	<p><b>BE AWARE</b>  <b>BE ALERT</b>  <b>BE TRAINED</b>  <b>BE ALIVE</b>  <b>Before Operating this Mower</b></p>
<p><b>ESTE CONSCIENTE SEA ENTRENADO</b>  <b>ESTE ALERTO Antes de Funcionar Cortacésped</b>  <b>ESTE VIVO</b></p>	<p>Para prevenir lesiones graves a usted y/o personas presentes, sea entrenado en la Práctica de Segar Seguro.</p> <p>Compañías de Alamo Group, Alamo Industrial, Bush Hog, M&amp;W, Rhino, Schulte y Tiger así como AEM y FEMA proporcionan material para entrenar que es esencial para su seguridad y la seguridad de otros al operar este equipo. Haga estos procedimientos de seguridad una parte importante de su día de trabajo. Lea y entienda el Manual de Operadores. No permita que personas sin entrenamiento funcionen este equipo.</p> <p>Contacte a su distribuidor, AEM (<a href="http://www.aem.org">www.aem.org</a>), FEMA (<a href="http://www.FarmEquipment.org">www.FarmEquipment.org</a>), o Alamo Group (<a href="http://www.Alamo-Group.com">www.Alamo-Group.com</a>) para la información sobre el material de entrenamiento o cursos que ofrecen el entrenamiento de Prácticas de Operación para Cortadoras.</p> <p>D559 SP</p>
<p>Para prevenir lesiones graves a usted y/o personas presentes, sea entrenado en la Práctica de Segar Seguro.</p> <p>Compañías de Alamo Group, Alamo Industrial, Bush Hog, M&amp;W, Rhino, Schulte y Tiger así como AEM y FEMA proporcionan material para entrenar que es esencial para su seguridad y la seguridad de otros al operar este equipo. Haga estos procedimientos de seguridad una parte importante de su día de trabajo. Lea y entienda el Manual de Operadores. No permita que personas sin entrenamiento funcionen este equipo.</p> <p>Contacte a su distribuidor, AEM (<a href="http://www.aem.org">www.aem.org</a>), FEMA (<a href="http://www.FarmEquipment.org">www.FarmEquipment.org</a>), o Alamo Group (<a href="http://www.Alamo-Group.com">www.Alamo-Group.com</a>) para la información sobre el material de entrenamiento o cursos que ofrecen el entrenamiento de Prácticas de Operación para Cortadoras.</p> <p>D559 SP</p>	<p>To prevent serious injury to yourself and/or bystanders, be trained in Safe Mowing Practices.</p> <p>Alamo Group Companies, Alamo Industrial, Bush Hog, M&amp;W, Rhino, Schulte, Tiger and Terrain King as well as AEM and FEMA provide training material that is critical for your Safety and the Safety of others when operating this equipment. Make these Safety Procedures an important part of every workday.</p> <p>Read and understand the Operator's Manual.</p> <p>Do not let untrained individuals operate this equipment.</p> <p>Contact your Dealer, AEM (<a href="http://www.aem.org">www.aem.org</a>), FEMA (<a href="http://www.FarmEquipment.org">www.FarmEquipment.org</a>), or Alamo Group (<a href="http://www.Alamo-Group.com">www.Alamo-Group.com</a>) for information on training material or courses that provide training in Safer Operating Practices for Mowers.</p> 

# SEGURIDAD

<p><b>▲ DANGER</b></p>		<p><b>Crushing Hazard</b></p>	<p><b>Transport Latch</b>  <b>RAISE AND</b>  <b>SECURELY LOCK</b>  <b>Wing Transport Latch</b>          before transporting          mower on roadways          or working under          wing.</p>	<p><b>▲ PELIGRO</b></p>		<p><b>Riesgo de</b>  <b>Aplastamiento</b></p>	<p><b>Cierre de</b>  <b>Transporte</b>  <b>LEVANTE Y DE</b>  <b>FORMA SEGURA</b>  <b>ATRANQUE</b> el cierre          de ala de transporte          antes de transportar          el cortacésped en          carretera o          trabajando abajo de          la ala.</p>
------------------------	---------------------------------------------------------------------------------------	-------------------------------	---------------------------------------------------------------------------------------------------------------------------------------------------------------------------------------------------------------------------------	-------------------------	--------------------------------------------------------------------------------------	---------------------------------------------------	-------------------------------------------------------------------------------------------------------------------------------------------------------------------------------------------------------------------------------------------------------------------------------------------------------------------

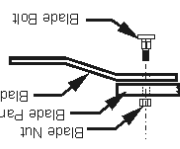
<p><b>▲ ADVERTENCIA</b></p>	<p><b>PARA EVITAR LESION</b>  <b>SERIA O MUERTE</b>  <b>POR EL FALLO DEL</b>  <b>ACOPPLAMIENTO DE</b>  <b>LAS CUCHILLAS:</b>          ● Apretar los tornillos a torsión de 600 libras pie.          ● Siempre reemplazar las cuchillas en pares.          ● SIEMPRE reemplazar las cuchillas con tornillos y tuercas nuevas. D651 SP-1</p>		<p><b>TO AVOID SERIOUS INJURY OR DEATH FROM BLADE ATTACHMENT FAILURE:</b>          ● Torque blade bolt to 600 ft lbs.          ● ALWAYS replace blades in pairs.          ● ALWAYS replace blades with new bolts and nuts.</p>
<p><b>▲ WARNING</b></p>			
<p><b>BLADE ROTATION</b></p>			
<p><b>ROTACIÓN DE CUCHILLAS</b></p>			

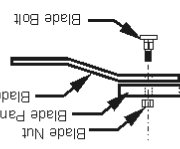
<p><b>▲ ADVERTENCIA</b></p>	<p><b>PARA EVITAR LESION</b>  <b>SERIA O MUERTE</b>  <b>POR EL FALLO DEL</b>  <b>ACOPPLAMIENTO DE</b>  <b>LAS CUCHILLAS:</b>          ● Apretar los tornillos a torsión de 600 libras pie.          ● Siempre reemplazar las cuchillas en pares.          ● SIEMPRE reemplazar las cuchillas con tornillos y tuercas nuevas. D652 SP-1</p>		<p><b>TO AVOID SERIOUS INJURY OR DEATH FROM BLADE ATTACHMENT FAILURE:</b>          ● Torque blade bolt to 600 ft lbs.          ● ALWAYS replace blades in pairs.          ● ALWAYS replace blades with new bolts and nuts.</p>
<p><b>▲ WARNING</b></p>			
<p><b>BLADE ROTATION</b></p>			
<p><b>ROTACIÓN DE CUCHILLAS</b></p>			

# SEGURIDAD

# SEGURIDAD

<b>▲ DANGER</b>		<b>▲ PELIGRO</b>	
<b>Crushing Hazard - Injury or Death</b>		<b>Riesgo de Aplastamiento Lesion o Muerte</b>	
<p><b>TO AVOID SERIOUS INJURY OR DEATH:</b></p> <ul style="list-style-type: none"> <li>STAND CLEAR when removing transport latch, lowering or raising wings.</li> <li>CLEAR AREA of bystanders before lowering implement wings.</li> <li>IMPLEMENT CAN FALL from hydraulic failure or accidental operation of controls.</li> <li>BLOCK UP and securely support equipment before putting hands, feet or body under raised equipment or lifted components.</li> <li>SECURELY ENGAGE transport latch before transportation or working under wing.</li> <li>FILL CYLINDERS with oil before attempting to lower implement wings.</li> <li>DO NOT OPERATE in transport position or with wings off ground.</li> </ul>		 	
<p><b>PARA EVITAR LESION SERIA O MUERTE:</b></p> <ul style="list-style-type: none"> <li>MANTENGASE LEJOS al quitar el cierre de transporte, bajando y devanando las alas.</li> <li>DESOCUPE EL AREA de personas presentes antes de bajar las alas del implemento.</li> <li>EL IMPLEMENTO PUEDE CAER del fracaso hidráulico o por operación accidental de controles.</li> <li>BLOQUEE y soporte con seguridad antes de poner manos, pies o cuerpo debajo del equipo de componentes levantados.</li> <li>CON SEGURIDAD ACTIVE el cierre de transporte antes de la transportación o trabajar debajo de las alas.</li> <li>LENE LOS CILINDROS con aceite antes de intentar de bajar las alas del implemento.</li> <li>NO OPERE en posición de transporte o con las alas devanadas del la tierra.</li> </ul>			



<b>▲ DANGER</b>		<b>▲ PELIGRO</b>	
<b>Crushing Hazard - Injury or Death</b>		<b>Riesgo de Aplastamiento Lesion o Muerte</b>	
<p><b>TO AVOID SERIOUS INJURY OR DEATH:</b></p> <ul style="list-style-type: none"> <li>STAND CLEAR when removing transport latch, lowering or raising wings.</li> <li>CLEAR AREA of bystanders before lowering implement wings.</li> <li>IMPLEMENT CAN FALL from hydraulic failure or accidental operation of controls.</li> <li>BLOCK UP and securely support equipment before putting hands, feet or body under raised equipment or lifted components.</li> <li>SECURELY ENGAGE transport latch before transportation or working under wing.</li> <li>FILL CYLINDERS with oil before attempting to lower implement wings.</li> <li>DO NOT OPERATE in transport position or with wings off ground.</li> </ul>		<p><b>CIERRE DE TRANSPORTE</b></p> <p>De forma segura atranque el cierre de transporte antes de transportar el cortacésped en carretera o trabajando abajo del implemento.</p>	
<p><b>TRANSPORT LATCH</b></p> <p>Securely lock Transport Latch before transporting mower on roadway or working under implement.</p>			

<b>▲ DANGER</b>		<b>▲ PELIGRO</b>	
<b>Crushing Hazard - Injury or Death</b>		<b>Riesgo de Aplastamiento Lesion o Muerte</b>	
<p><b>TO AVOID SERIOUS INJURY OR DEATH:</b></p> <ul style="list-style-type: none"> <li>STAND CLEAR when removing transport latch, lowering or raising wings.</li> <li>CLEAR AREA of bystanders before lowering implement wings.</li> <li>IMPLEMENT CAN FALL from hydraulic failure or accidental operation of controls.</li> <li>BLOCK UP and securely support equipment before putting hands, feet or body under raised equipment or lifted components.</li> <li>SECURELY ENGAGE transport latch before transportation or working under wing.</li> <li>FILL CYLINDERS with oil before attempting to lower implement wings.</li> <li>DO NOT OPERATE in transport position or with wings off ground.</li> </ul>		<p><b>OPERATE</b></p> <p>DO NOT OPERATE</p> <p><b>GUARD MISSING</b></p> <p>DO NOT OPERATE</p>	
			
<b>▲ DANGER</b>		<b>▲ PELIGRO</b>	
<b>Crushing Hazard - Injury or Death</b>		<b>Riesgo de Aplastamiento Lesion o Muerte</b>	
<p><b>TO AVOID SERIOUS INJURY OR DEATH:</b></p> <ul style="list-style-type: none"> <li>STAND CLEAR when removing transport latch, lowering or raising wings.</li> <li>CLEAR AREA of bystanders before lowering implement wings.</li> <li>IMPLEMENT CAN FALL from hydraulic failure or accidental operation of controls.</li> <li>BLOCK UP and securely support equipment before putting hands, feet or body under raised equipment or lifted components.</li> <li>SECURELY ENGAGE transport latch before transportation or working under wing.</li> <li>FILL CYLINDERS with oil before attempting to lower implement wings.</li> <li>DO NOT OPERATE in transport position or with wings off ground.</li> </ul>		<p><b>FALTA EL</b></p> <p>CUBIERTA</p> <p>NO OPERE</p>	

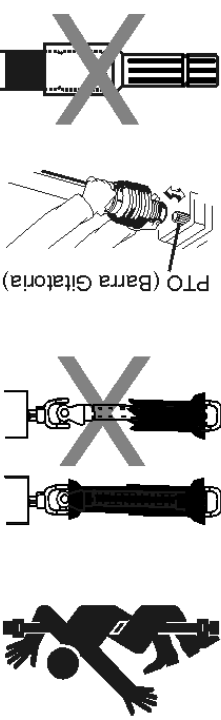
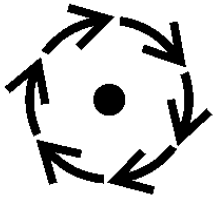

# SEGURIDAD

# SEGURIDAD



<b>⚠ PELIGRO</b>	<b>⚠ DANGER</b>	
<p>PARA EVITAR LESION SERIA O MUERTE POR CONTACTO A LA LINEA DE CONDUCCION, SEPARACION DE CONDUCCION, SEPARACION DE LINEA DE CONDUCCION O EL FRACASO DEL EJE DE PTO:</p> <ul style="list-style-type: none"> <li>• PARE, MIRE y ESCUCHE por el movimiento de rotacion antes de acercarse al implemento.</li> <li>• MANTENGASE ALEJADO y MANTENGA manos, pies y cuerpo LEJOS de partes girando, hasta que todos los elementos de movimiento se han parado.</li> <li>• SIEMPRE apage la Toma De Fuerza (Barra Gítorria) antes de desmontar.</li> <li>• NO opere si las cubiertas de Toma De Fuerza (Barra Gítorria) estan dañadas.</li> <li>• EMPUJE Y JALE el yugo hasta que el collar de fijación hace clic y el yugo se traba en lugar.</li> <li>• REVISE las guardias de línea de conducción por giracion libre y suficiente trasape para evitar areas sin cobertura.</li> <li>• NO UTILICE UN ADAPTOR PARA LA TOMA DE FUERZA (Barra Gítorria).</li> </ul>	 <p>PTO (Barra Gítorria)</p>	<p><b>TO AVOID SERIOUS INJURY OR DEATH FROM DRIVELINE CONTACT, DRIVELINE SEPARATION OR PTO SHAFT FAILURE:</b></p> <ul style="list-style-type: none"> <li>• STOP, LOOK and LISTEN for rotating motion before approaching implement.</li> <li>• STAY AWAY and KEEP hands, feet and body AWAY from rotating parts until all moving elements have stopped.</li> <li>• ALWAYS shut off PTO before dismounting.</li> <li>• DO NOT operate if PTO shields are damaged or missing.</li> <li>• PUSH AND PULL on yoke until collar clicks and locks yoke in place.</li> <li>• CHECK driveline guards for free rotation and sufficient overlap to avoid unshielded areas.</li> <li>• DO NOT USE PTO ADAPTER</li> </ul>
<p>SOLAMENTE OPERE ESTA MAQUINA A 540 RPM</p> <p>VELOCIDAD DE PTO (TOMA DE FUERZA O BARRA GÍTORRIA) DEL TRACTOR DE 540 RPM. El exceso de velocidad de PTO puede causar el fracaso de componente que resultara en lesión. ROTACION DE PTO DEL TRACTOR: EN SENTIDO HORARIO D547 SP</p>		<p>OPERATE THIS MACHINE AT 540 RPM</p> <p>TRACTOR PTO SPEED ONLY. Overspeeding PTO may cause component failure resulting in bodily injury. TRACTOR PTO ROTATION: CLOCKWISE</p>
<b>⚠ ADVERTENCIA</b>	<b>⚠ WARNING</b>	
<p>SOLAMENTE OPERE ESTA MAQUINA A 1000 RPM</p> <p>VELOCIDAD DE PTO (TOMA DE FUERZA O BARRA GÍTORRIA) DEL TRACTOR DE 540 RPM. El exceso de velocidad de PTO puede causar el fracaso de componente que resultara en lesión. ROTACION DE PTO DEL TRACTOR: EN SENTIDO HORARIO D548 SP</p>		<p>OPERATE THIS MACHINE AT 1000 RPM</p> <p>TRACTOR PTO SPEED ONLY. Overspeeding PTO may cause component failure resulting in bodily injury. TRACTOR PTO ROTATION: CLOCKWISE</p>

# SEGURIDAD

# SEGURIDAD

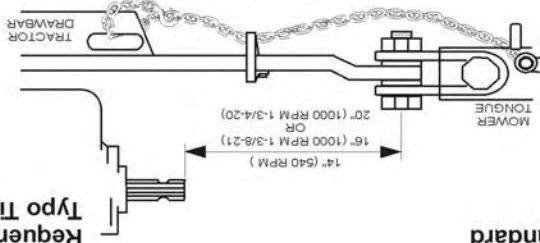
<p><b>ADVERTENCIA</b></p>	<p><b>WARNING</b></p>
<p><b>PARA EVITAR INCENDIOS DE EQUIPO Y CÉSPED:</b></p> <ul style="list-style-type: none"> <li>• QUITE el césped o escombros de engranajes, líneas de conducción y cubiertas.</li> <li>• <b>PARA EVITAR INCENDIOS POR IGNICIÓN:</b></li> <li>• NO PERMITA QUE LAS LAMINAS CONTACTEN piedras, metal o objetos sólidos.</li> </ul> <p>D563-3</p>	<p><b>TO AVOID EQUIPMENT AND GRASS FIRES:</b></p> <ul style="list-style-type: none"> <li>• CLEAR AWAY grass or debris from slip clutches, gearboxes, drivelines and decks.</li> <li>• DO NOT ALLOW BLADES TO CONTACT rocks, metal or solid objects.</li> </ul> <p><b>TO AVOID FIRE IGNITION:</b></p> 

<p><b>IMPORTANTE</b></p>	<p><b>IMPORTANT</b></p>
<p><b>Requerido por Unidades de Tipo Tirón Estándar.</b></p>  <p>Attach Safety Chain securely. Coloque la Cadena de Seguridad seguramente.</p> <p>D563-4</p>	<p><b>Required for Standard Pull Type Units.</b></p>

<p><b>PELIGRO</b></p>	<p><b>DANGER</b></p>
<p><b>Riesgo de Aplastamiento Lesion o Muerte</b></p> <p>LA SECCION CENTRAL PUEDE LEVANTARSE Y VOLTEAR SIN CONTRAPESO. PARA EVITAR LESION SERIA O MUERTE: NO OPERE sin el contrapeso. NO LEVANTE LA ALA sin contrapeso. Instale contrapeso con un mínimo de 700 lbs antes de operar.</p>  <p>Con peso With weight</p>	<p><b>Crushing Hazard - Injury or Death</b></p> <p>CENTER SECTION MAY LIFT AND TURN OVER WITHOUT COUNTER WEIGHT. TO AVOID SERIOUS INJURY OR DEATH: DO NOT OPERATE without counterweight. DO NOT LIFT WING without counterweight. 700 lbs before operating. Install a counterweight with a minimum of 700 lbs before operating.</p>  <p>Sin peso Without weight</p>

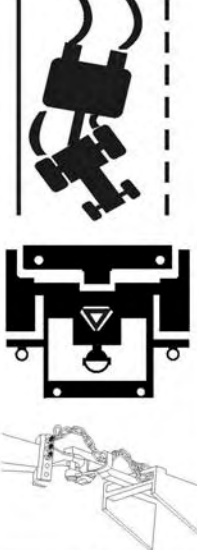
<p><b>▲ ADVERTENCIA</b></p> <p><b>PARA EVITAR LESION SERIA O MUERTE POR LA PENETRACION A LA PIEL POR ALTA PRESION DE ACEITE HIDRAULICO:</b></p> <ul style="list-style-type: none"> <li>• NO OPERE el equipo con fugas de aceite o combustible.</li> <li>• MANTENGA todas las mangueras hidráulicas, líneas y conexiones en buenas condiciones y apretadas antes de aplicar presión al sistema.</li> <li>• Relieve la presión hidráulica antes de desconectar las líneas o trabajar en le sistema.</li> <li>• QUITE y reemplace la manguera si sospecha que hay fuga.</li> </ul> <p><b>FUGAS DE ALTA PRESION PUEDEN SER INVISIBLE. AL VERIFICAR POR FUGAS HIDRAULICAS Y TRABAJANDO ALREDEDOR DE SISTEMAS HIDRAULICOS:</b></p> <ul style="list-style-type: none"> <li>• NO use las manos para verificar si hay agujeros.</li> <li>• SIEMPRE USE lentes de seguridad y guantes impenetrables.</li> <li>• USE papel o un cartón para buscar agujeros.</li> <li>• NO USE las manos o partes del cuerpo para buscar agujeros.</li> <li>• MANTENGA manos y cuerpo LEJOS de agujeros de alfiler y boquillas que expulsan el líquido hidráulicos.</li> </ul> <p>D553-1</p>		<p><b>▲ WARNING</b></p> <p><b>TO AVOID SERIOUS INJURY OR DEATH FROM HIGH PRESSURE HYDRAULIC OIL LEAKS PENETRATING SKIN:</b></p> <ul style="list-style-type: none"> <li>• DO NOT OPERATE equipment with oil or fuel leaks.</li> <li>• KEEP all hydraulic hoses, lines and connections in good condition and tight before applying system pressure.</li> <li>• Relieve hydraulic pressure before disconnecting lines or working on the system.</li> <li>• REMOVE and replace hose if you suspect it leaks. Have dealer test it for leaks.</li> <li>• DO NOT use hands to check for leaks.</li> <li>• ALWAYS WEAR safety glasses and impenetrable gloves.</li> <li>• USE paper or cardboard to search for leaks.</li> <li>• KEEP hands and body AWAY from pin holes and nozzles ejecting hydraulic fluid.</li> <li>• Hydraulic fluid may cause gangrene if not surgically removed immediately by a doctor familiar with this form of injury.</li> </ul>
<p><b>▲ ADVERTENCIA</b></p> <p><b>PARA EVITAR LESION SERIA O MUERTE AL REMOLCAR EL EQUIPO:</b></p> <ul style="list-style-type: none"> <li>• NO REMOLQUE con camion o cualquier otro vehículo.</li> <li>• SOLO transporte con un tractor bien equipado y de tamaño adecuado (Vea el Manual de Operador)</li> <li>• APLIQUE LA CEDENA DE SEGURIDAD al tractor.</li> <li>• VERIFIQUE EL SMV, reflectors, y luces intermitentes de advertencia pueden ser vistos claramente por detras de la unidad.</li> <li>• PRIENDA las luces intermitentes de advertencia.</li> </ul> <p><b>PARA EVITAR PERDIDA DE CONTROL DE REMOLQUE:</b></p> <ul style="list-style-type: none"> <li>• NO remolque en velocidades arriba de 20 mph.</li> <li>• REDUZCA LA VELOCIDAD en inclinass, en vueltas y en las pobres condiciones de remolque.</li> </ul> <p>D553-2</p>		<p><b>▲ WARNING</b></p> <p><b>TO AVOID SERIOUS INJURY AND DEATH WHEN TOWING EQUIPMENT:</b></p> <ul style="list-style-type: none"> <li>• DO NOT TOW with trucks or other vehicles.</li> <li>• ONLY transport with properly sized and equipped tractor. (see Operator's Manual)</li> <li>• ATTACH implement SAFETY CHAIN to tractor.</li> <li>• CHECK SMV sign, reflectors and warning lights for visibility behind unit.</li> <li>• TURN ON tractor flashing warning lights.</li> </ul> <p><b>TO AVOID LOSS OF TOWING CONTROL:</b></p> <ul style="list-style-type: none"> <li>• DO NOT tow at speeds over 20 mph.</li> <li>• REDUCE SPEED on inclines, in turns and in poor towing conditions.</li> </ul>

# SEGURIDAD







# SEGURIDAD

<p><b>PELIGRO</b></p>			
			
<p><b>PARA EVITAR LESION SERIA O MUERTE:</b></p> <ul style="list-style-type: none"> <li>● LEA Y ENTIENDA el Manual de Operador proporcionado, signos de seguridad y calcomanías informativas para el tractor y implemento antes de operar el equipo.</li> <li>● CONTACTE AL DISTRIBUIDOR inmediatamente si no tiene los manuales.</li> <li>● CONTACTE AL DISTRIBUIDOR para que le explique cualquier instrucciones que no entienda completamente.</li> <li>● SIEMPRE USE lentes de seguridad.</li> <li>● USE un casco, zapatos de seguridad y guantes para su protección cuando esta operando el equipo.</li> </ul>			
<p><b>DANGER</b></p>			
			
<p><b>TO AVOID SERIOUS INJURY OR DEATH:</b></p> <ul style="list-style-type: none"> <li>● READ AND UNDERSTAND the provided Operator's Manuals, safety signs and information decals for tractor and implement before operating equipment.</li> <li>● CONTACT DEALER immediately if you do not have manuals.</li> <li>● CONTACT DEALER to explain any instructions not fully understood.</li> <li>● ALWAYS WEAR safety glasses.</li> <li>● WEAR hard hat, safety shoes and gloves for protection when operating equipment.</li> </ul>			

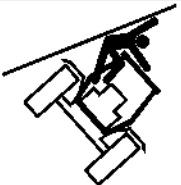
D549 SP 5

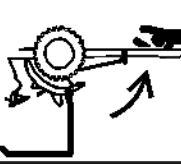
# SEGURIDAD

# SEGURIDAD

					
<p><b>Riesgo de Aplastamiento - Lesion o Muerte</b></p> <p><b>PELIGRO</b></p>			<p><b>Crushing Hazard - Injury or Death</b></p> <p><b>DANGER</b></p>		
<p><b>PARA EVITAR LESION SERIA O MUERTE:</b></p> <ul style="list-style-type: none"> <li>● USE un tractor equipado con Estructura Protectora Contra Vueltos ("ROPS") incluyendo barra antivuelco y cinturón de seguridad. Mantenga la barra antivuelco en la posición elevada.</li> <li>● PERMANEZCA ALEJADO al quitar el seguro de transporte, y al bajar o subir las alas.</li> <li>● EL IMPLEMENTO SE PUEDE CAER por el mal funcionamiento hidráulico o operación accidental de los controles.</li> <li>● BLOQUEE y soporte con seguridad el equipo antes de poner manos, pies o cuerpo debajo del equipo o componentes levantados.</li> </ul>			<p><b>TO AVOID SERIOUS INJURY OR DEATH:</b></p> <ul style="list-style-type: none"> <li>● USE tractor equipped with Rollover Protective Structure ("ROPS") including roll bar and seat belt. Keep roll bar in raised position.</li> <li>● STAND CLEAR when removing transport latch, lowering or raising wings.</li> <li>● IMPLEMENT CAN FALL from hydraulic failure or accidental operation of controls.</li> <li>● BLOCK UP and securely support equipment before putting hands, feet or body under raised equipment or lifted components.</li> </ul>		
			<p>D549 SP 4</p>		

# SEGURIDAD

# SEGURIDAD

		 <p>Tractor PTO Guard (Cubierta de PTO) Implement PTO Guard (Cubierta de PTO) Shields (Cubiertas)</p>			 <p>Tractor PTO Guard Implement PTO Guard Shields</p>
<h2>PELIGRO</h2>			<h3>RIESGO DE ENREDAMIENTO</h3> <p><b>PARA EVITAR LESION SERIA O MUERTE:</b></p> <ul style="list-style-type: none"> <li>● NO opere sin la cubierta protectora en su lugar y en buen estado. Toma De Fuerza (Barra Gitaño) y guardias de caja de engranaje son SUJETO AL ESGASTE.</li> <li>● MANTENGASE ALEJADO y MANTENGA manos, pies y cuerpo LEJOS de las cuchillas girando, líneas de conducción, y partes que siguen moviéndose después de que el poder es apagado. ESPERE hasta que todos los elementos móviles se han parado.</li> <li>● SIEMPRE REEMPLACE CUBIERTAS que han sido quitadas para servicio o mantenimiento.</li> <li>● DETENGASE, OBSERVE y ESCUCHE por el movimiento de rotación antes de acercarse al implemento.</li> <li>● NO PISE EN las líneas de conducción o cubiertas.</li> </ul>		
<h2>DANGER</h2>			<h3>ENTANGLEMENT HAZARD</h3> <p><b>TO AVOID SERIOUS INJURY OR DEATH:</b></p> <ul style="list-style-type: none"> <li>● DO NOT operate without guards in place and in good condition. PTO and gearbox guarding are SUBJECT TO WEAR.</li> <li>● STAY AWAY and KEEP hands, feet and body AWAY from rotating blades, drivelines and parts that continue to move after power shut-off. WAIT until all moving elements have stopped.</li> <li>● ALWAYS REPLACE GUARDS that have been removed for service or maintenance.</li> <li>● STOP, LOOK and LISTEN for rotating motion before approaching implement.</li> <li>● DO NOT STEP ON drivelines or guards.</li> </ul>		

**PELIGRO**

**Riesgo de Atropello Lesión o Muerte**

**PARA EVITAR LESION SERIA O MUERTE:**

- SIEMPRE ABROCHE el cinturón de seguridad.
- SOLO ENCIENDA el tractor mientras que esta sentado en el asiento del operador.
- PARE EL MOTOR Y Toma De Fuerza (Barro Gítoría), aplique el freno de mano, baje el implemento, y deje que todas las partes móviles paren completamente, y quite la llave antes de desmontar el tractor.
- ENTIENDA COMO parar el tractor y equipo rápidamente en caso de una emergencia.
- NO MONTE o DESMONTE el tractor en movimiento.
- NUNCA PERMITA pasajeros en el tractor o implemento.
- NUNCA PERMITA que niños operen o se monten en el tractor o implemento.
- MANTENGA LAS PERSONAS PRESENTES LEJOS de la area antes de mover el tractor o implemento.
- MANTENGASE ALERTO y EVITE golpes en troncos, agujeros, pozos o terreno en desnivel.
- EVITE las ramas de árbol, maleza y algún otros objetos que sobresalen que puedan golpear y tumbar el operador del asiento.

**DANGER**

**Run Over Hazard - Injury or Death**

**TO AVOID SERIOUS INJURY OR DEATH:**

- ALWAYS BUCKLE UP seat belt.
- ONLY START Tractor while seated in the operator's seat.
- STOP ENGINE and PTO, engage parking brake, lower implement, allow all moving parts to stop and remove key before dismounting from tractor.
- KNOW HOW to stop tractor and equipment quickly for an emergency.
- DO NOT MOUNT or DISMOUNT Tractor in motion.
- NEVER ALLOW riders on tractor or implement.
- NEVER ALLOW children to operate or ride on tractor or implement.
- KEEP BYSTANDERS CLEAR of area before moving tractor or implement.
- KEEP ALERT and AVOID hitting stumps, holes, ruts, and uneven terrain.
- AVOID tree limbs, brush and other overhanging objects that can strike and throw the operator from seat.

D549 SP 2

**PELIGRO**

**RIESGO DE OBJETOS LANZADOS**

- Contáctespued puede lanzar objetos hasta 300 pies. PARA EVITAR LESION SERIA O MUERTE a operadores y personas presentes: Pare de segar si personas o tráfico se acercan entre 300 pies del área de segar.
- NO OPERE sin la cubierta para objetos lanzados.
  - MANTENGA la cubierta para objeto lanzado en su lugar y en buenas condiciones. Los protectores de objetos lanzados son sujetos al desgaste.
  - REPARA O REEMPLAZA cubiertas si son dañadas, quebradas, o si faltan.
  - INSPECCIONE el área por si hay riesgos potenciales de objetos lanzados antes de segar.
  - REMUEVA y EVITE objetos como alambre, cable, objetos de metal y todo otro material extraño.
  - NO DEJE que las cuchillas contacten los objetos sólidos como alambre, rocas, postes, borde de banqueta, o barandillas.
  - NO OPERE en posición de transporte o con las alas levantadas.

**DANGER**

**THROWN OBJECTS HAZARD**

- Mower can throw objects up to 300 feet. TO AVOID SERIOUS INJURY OR DEATH to operator or bystanders:
- STOP mowing if bystanders or traffic come within 300 feet.
  - DO NOT OPERATE with thrown object shielding removed.
  - KEEP thrown object shielding in place and in good condition during operation. Thrown Objects shielding is subject to wear.
  - REPAIR OR REPLACE shielding if damaged, broken or missing. See Operator's Manual for all Shields and Guards.
  - INSPECT area for potential mower thrown object hazards before mowing.
  - Remove and AVOID objects such as wire, cable, metal objects and all other foreign material.
  - DO NOT ALLOW blades to contact solid objects like wire, rocks, posts, curbs or guard rails.
  - DO NOT OPERATE in transport position or with wings off ground.

D549 SP 1



**INFORMACIÓN DE PARTES**

**INFORMACIÓN DE PARTES**

Las cortadoras BUSH HOG usan balancadas y componentes de sistema seleccionado para los portadores de cuchillas, cuchillas, eje de cortar, navaja, suspensiones de navajas, los rodillos, los componentes de línea motriz, y cojinetes. Estas partes son echas y probadas a la especificaciones de BUSH HOG. Partes que no son auténticas no regularmente llegan con estas especificaciones. El uso de partes que no son auténticas puede reducir el funcionamiento de la cortadora, anular garantías, y presentar un peligro de seguridad. Use partes de cortadora auténticas de BUSH HOG por economía y seguridad. (SPBH-1 SP)

**CONTACTE A SU DISTRIBUIDOR BUSH HOG**

Manuales de Partes Y Operador





[www.aligqr.com/bpm](http://www.aligqr.com/bpm)

**NOTA:** Si necesita un manual completamente en español por favor de ponerse en contacto a:  
Translations, dirección 1502 E. Walnut Street Seguin, TX 78155; Fax: (830) 372-9529

# SEGURIDAD

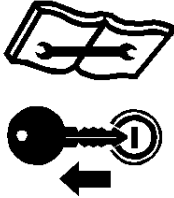
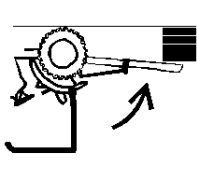
## RIESGOS CON EL MANTENIMIENTO DE IMPLEMENTO

	Inspeccione periódicamente todas las partes móviles, lubrique las líneas de conducción y ajuste todas las sujeciones.
	Apague el motor. Quite la llave antes de realizar tareas de mantenimiento.
	Bloquee el implemento antes de repararlo. Utilice bloques grandes sobre suelo blando o húmedo.
	Coloque las trabas de transporte cilíndricas.
	Inspeccione las cuchillas para detectar daños o fisuras.



MANTENGA LOS IMPLEMENTOS EN BUENAS CONDICIONES DE FUNCIONAMIENTO, A TRAVÉS DE UN SERVICIO, REPARACIÓN O MANTENIMIENTO APROPIADO.

### ANTES DE REALIZAR TAREAS DE SERVICIO, REPARACIÓN Y MANTENIMIENTO DEL IMPLEMENTO:

- **ASEGURE EL EQUIPO PARA EL SERVICIO**
- **BLOQUEE LOS RIESGOS POTENCIALES DE ENERGÍA:** piezas giratorias, componentes levantados, presión hidráulica.
- **APAGUE EL MOTOR Y EL PTO,** coloque el freno de mano, descienda el implemento, espere a que se detengan todas las partes móviles y quite la llave antes de bajarse del tractor.
- **COLOQUE** el implemento sobre el suelo o trabe de manera segura los equipos elevados. Utilice bloques grandes sobre suelo blando o húmedo.
- **CIERRE FIRMEMENTE Y TRABE** las alas del implemento levantado.
- **TRABE LA LENGUA DEL IMPLEMENTO** con bloques grandes y el gato de remolque. NO gatee o trabaje debajo del implemento solo sostenido por el gato de remolque.
- **EMPÚJE Y JALE** la palanca del Cilindro Hidráulico Remoto para liberar la presión hidráulica.
- **DESCONECTE** las mangueras hidráulicas de implemento del tractor.
- **DESCONECTE** la línea de conducción del **IMPLEMENTO** del **EJE DE PTO** del tractor.

**USE GAFAS DE SEGURIDAD Y GUAANTES PROTECTORES Y SIGA todos los PROCEDIMIENTOS DE SEGURIDAD al realizar tareas de servicio, reparación y mantenimiento sobre el implemento:**

- Siempre **USE GUAANTES** protectores al manipular las hojas, cuchillas, bordes filosos o un componente desgastado con bordes filosos.
- Siempre **USE GUAANTES Y GAFAS DE SEGURIDAD** al reparar componentes en caliente.
- **EVITE EL CONTACTO** con tanques de aceite hidráulico, bombas, motores, válvulas y superficies de conexión de mangueras calientes.

- **SUJETE FIRMEMENTE** o **TRABE EN POSICIÓN ELEVADA** todos los implementos, bastidores y componentes elevados antes de trabajar sobre los equipos que se encuentran debajo.
- **DETENE** el movimiento de todos los implementos y **APAGUE EL MOTOR DEL TRACTOR** antes de realizar ninguna tarea. USE una escalera o gradas elevadas para alcanzar áreas altas del equipo a las que no se pueda acceder desde la tierra. **ASEGURESE** de estar bien apoyado sobre superficies sólidas planas al subir al implemento para realizar tareas.
- **SIGA** las instrucciones del fabricante sobre cómo manipular los lubricantes, solventes, limpiadores y otros agentes químicos. NO cambie ninguna calibración hidráulica de fábrica para evitar fallas de los componentes o equipos.
- **NO** modifique o altere el implemento, las funciones o componentes.
- **NO** SUELDE o repare los componentes de la cortadora. Esto puede causar vibraciones y fallas de los componentes que se desprendan de la cortadora.





### REALICE LAS TAREAS DE SERVICIO, REPARACIÓN, LUBRICACIÓN Y MANTENIMIENTO QUE SE DESCRIBEN EN LA SECCION DE MANTENIMIENTO DEL IMPLEMENTO:

- **INSPECCIONE** el implemento para detectar sujeciones sueltas, partes gastadas o rotas, ajustes sueltos o con filtraciones, que los pasadores tengan clavetas y arandelas, y las partes móviles para detectar el desgaste.
- **REEMPLACE** todas las partes gastadas o rotas con repuestos autorizados.
- **LUBRIQUE** la unidad tal como se especifica en el cronograma de lubricación.
- **NUNCA** lubrique, ajuste o quite material mientras el equipo está en funcionamiento o movimiento.
- **AJUSTE** todas las tuercas y pernos tal como se especifica.

- **INSPECCION DE CUCHILLAS:**
- **REEMPLACE** las cuchillas dobladas, dañadas, agrietadas o rotas inmediatamente por cuchillas nuevas.
- **EVITE** fallas de las cuchillas y que vuelen trozos de cuchillas. NO enderrece, suelde o suelde con superficies rígidas.
- **MANTENGA** en su lugar en buen estado todos los deflectores, protectores de cadena, protectores de caja de engranajes, cubiertas integrales de PTO, bandas, faldones laterales y zapatas antideslizantes.
- **REEMPLACE** cualquier protector, cubierta o dispositivo de seguridad faltante, roto o gastado.
- El escape del motor, al igual que algunos de sus componentes, y determinados elementos del vehículo contienen o emiten agentes químicos que el estado de California ha determinado que causan cáncer, defectos de nacimiento y otros daños reproductivos.
- Las terminales de baterías y los accesorios relacionados contienen plomo y componentes de plomo, que el estado de California ha determinado son químicos que causan cáncer, defectos de nacimiento u otros daños reproductivos. **PNHMO1 SP**

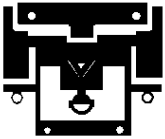
# SEGURIDAD

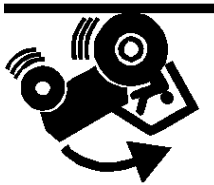
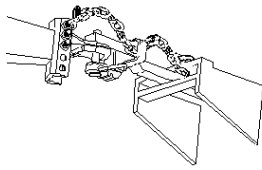
## RIESGOS DE TRANSPORTE

 <p>Use señales de SMV (vehículo de movimiento lento) y balizas</p>	 <p>Peligro de detención por pérdida de control</p>	 <p>Peligro de velocidad excesiva por pérdida de control</p>	 <p>Use la cadena de remolque de seguridad – Tractor a implemento</p>	 <p>Coloque las trabas de transporte</p>
----------------------------------------------------------------------------------------------------------------------------------------------------------	-----------------------------------------------------------------------------------------------------------------------------------------	-------------------------------------------------------------------------------------------------------------------------------------------------	----------------------------------------------------------------------------------------------------------------------------------------------------------	-----------------------------------------------------------------------------------------------------------------------------

**ADVERTENCIA** PARA EVITAR LESIONES GRAVES O LA MUERTE AL REMOLCAR O TRANSPORTAR EQUIPOS:

- **MANTENGA** la velocidad de transporte **POR DEBAJO DE 20** millas por hora para mantener el control del equipo.
- **REDUZCA LA VELOCIDAD** en terreno inclinado, en las curvas y en condiciones de remolque desfavorables.
- **NO REMOLQUE** camiones u otros vehículos
- **USE** un tractor de tamaño adecuado y equipado en función del equipo de remolque.
- **SIGA** todas las regulaciones de tránsito locales.
- **REQUISITOS DEL TRACTOR PARA REMOLCAR O TRANSPORTAR IMPLEMENTOS:**
- **SOLO TRANSPORTE** en el tractor con el mecanismo **ROPS** (antivuelco) en posición elevada.
- **USE** un tractor de tamaño adecuado y equipado, que supere el peso del implemento en al menos un 20%
- **MANTENGA EL 20%** del peso del tractor en las ruedas frontales para mantener la dirección en forma segura.
- **ANTES DE TRANSPORTAR O REMOLCAR EL IMPLEMENTO:**
- **INSPECCIÓN DEL TRACTOR:**
- **VERIFIQUE** la dirección y los frenos para asegurarse el correcto funcionamiento y las condiciones adecuadas.
- **VERIFIQUE LLEVAR EL AVISO DE SMV**, los reflectores y las luces de advertencia para la adecuada operación y visibilidad detrás de la unidad.
- **VERIFIQUE** que no haya impedimentos a la visión mientras conduce, en el tractor, la cabina o el implemento, sentado en el asiento del tractor.
- **AJUSTE** su posición de conducción, los espejos y el transporte del implemento para tener una visión clara para condiciones de conducción y tránsito.
- **PREPARE EL IMPLEMENTO PARA EL TRANSPORTE O EL REMOLQUE:**
- **COLOQUE LAS TRABAS PARA TRANSPORTE Y LAS CADENAS DE SEGURIDAD:**
- **ELEVE LA CORTADORA e INSTALE** topes o pasadores de transporte cilíndricos en el eje central
- **ELEVE LAS ALAS e INSTALE TRABAS DE TRANSPORTE** o pasadores.
- **AJUSTE LA CADENA DE SEGURIDAD** del implemento al tractor.
- **QUITTE** todo material cortado que se acumule en la plataforma de la cortadora.
- **DETERMINAR LAS CARACTERÍSTICAS DE DETENCIÓN DEL TRACTOR Y EL IMPLEMENTO PARA EL TRANSPORTE O REMOLQUE:**
- **PRUEBAS DE FRENADO:**
- **FRENE** a velocidades en aumento.
- **Observe** las distancias de **DETECCIÓN** con el aumento de velocidad.
- **DETERMINE** la velocidad de transporte máxima segura que no supere las 20 millas por hora.
- **DETERMINE LA VELOCIDAD DE GIRO MÁXIMA ANTES DE OPERAR EN CARRETERAS O TERRENO IRREGULAR:**
- **PONGA A PRUEBA** el equipo aumentando lentamente la velocidad en las curvas para determinar si se puede operar a mayor velocidad.
- **USE MENORES** velocidades de giro en las curvas pronunciadas para evitar el vuelco.
- **AL REMOLCAR O TRANSPORTAR EL EQUIPO:**
- Siempre **USE EL CINTURÓN DE SEGURIDAD** al operar o transportar la cortadora.
- **USE** bajas velocidades para evitar el vuelco con las alas elevadas.
- **USE** bajas velocidades y dirección gradual en las curvas, colinas, o en superficies irregulares o poco uniformes, y en carreteras mojadas.
- **ENCIENDA LAS BALIZAS DE ADVERTENCIA** del tractor.
- **TENGA EN CUENTA** el espacio necesario para el valién del implemento en las curvas.
- **MANTENGA** todas las alas elevadas a 3 metros (10 pies) o una mayor distancia de todos los cables de alimentación y obstrucciones elevadas. *PN TH01 SP*

- **PONGA A PRUEBA** el equipo aumentando lentamente la velocidad en las curvas para determinar si se puede operar a mayor velocidad.
- **USE MENORES** velocidades de giro en las curvas pronunciadas para evitar el vuelco.
- **AL REMOLCAR O TRANSPORTAR EL EQUIPO:**
- Siempre **USE EL CINTURÓN DE SEGURIDAD** al operar o transportar la cortadora.
- **USE** bajas velocidades para evitar el vuelco con las alas elevadas.
- **USE** bajas velocidades y dirección gradual en las curvas, colinas, o en superficies irregulares o poco uniformes, y en carreteras mojadas.
- **ENCIENDA LAS BALIZAS DE ADVERTENCIA** del tractor.
- **TENGA EN CUENTA** el espacio necesario para el valién del implemento en las curvas.
- **MANTENGA** todas las alas elevadas a 3 metros (10 pies) o una mayor distancia de todos los cables de alimentación y obstrucciones elevadas. *PN TH01 SP*

# SEGURIDAD

## RIESGOS ELÉCTRICOS Y DE FUEGO

		<p>Contacto de ala con cables eléctricos elevados</p> <p>Riesgo de choque y explosión</p> <p>Contacto de paletas con líneas de servicios o gas</p>
<p>Contacto de ala con cables eléctricos elevados</p>	<p>Riesgo de choque y explosión</p> <p>Contacto de paletas con líneas de servicios o gas</p>	<p>No opere cerca de fuego. Mantenga limpia la plataforma de la cortadora</p>



**▲ PELIGRO** PARA EVITAR LESIONES GRAVES O LA MUERTE POR CONTACTO ELÉCTRICO AL TRABAJAR CERCA DE CABLES ELÉCTRICOS, LÍNEAS DE GAS Y DE SERVICIOS:

- **INSPECCIONE** el área de corte para que no interfiera con cables de alimentación eléctricos subterráneos, obstrucciones, líneas de gas, cables y servicios, estructuras municipales o de otro tipo.
- **MANTENGA** todas las alas elevadas a 3 metros (10 pies) o una mayor distancia de todos los cables de alimentación y obstrucciones elevadas.
- **NO** ponga en contacto la cortadora con ninguna estructura u obstrucción de servicios o municipales.
- **LLAME** AL 811 y al 1-800-258-0808 para identificar cables de servicios subterráneos.
- **PAUTAS DE PREVENCIÓN DE INCENDIOS** durante la operación, reparación y servicio de la cortadora y el tractor, a fin de reducir el riesgo de incendio del equipo y de la vegetación:
  - El tractor debe estar **EQUIPADO CON MATAFUEGOS**
  - **NO OPERE** la cortadora sobre un tractor equipado con escape debajo del bastidor
  - **NO FUME** ni acerque fuego directo a la cortadora o el tractor
  - **NO CONDUZCA** sobre residuos encendidos o en áreas recientemente quemadas
  - **EVITE LA FORMACIÓN DE CHISPAS** al no permitir que la hoja de la cortadora entre en contacto con objetos sólidos como metal o roca.
  - **AJUSTE LOS EMBRAGUES DESLIZANTES** para evitar el deslizamiento excesivo y el calentamiento de la placa del embrague.
  - **LIMPIE** todo resto de hierba o residuo acumulado alrededor de las líneas de conducción de la cortadora, los embragues deslizantes y cajas de cambios.
  - **APAGUE EL MOTOR** al cargar combustible. *PN EF01 SP*

# SEGURIDAD

# SEGURIDAD

## RIESGO DEL CONTACTO A LAS CUCHILLAS DE CORTADORA

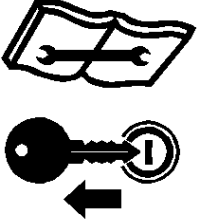
		
No ponga los dedos debajo de la cortadora	No ponga el pie debajo de la cortadora	Detenga el tractor. Quite la llave. Lea el Manual

**PELIGRO** MANTÉNGASE LEJOS DE LAS CUCHILLAS GIRATORIAS PARA EVITAR LESIONES GRAVES O LA MUERTE POR CONTACTO CON LA CUCHILLA:

- MANTÉNGASE LEJOS y NO ACERQUE LAS MANOS, LOS PIES y EL CUERPO a las cuchillas giratorias, líneas de conducción y partes hasta que todos los elementos móviles se hayan detenido.
- NO ponga las manos o los pies debajo de las plataformas de la cortadora
- DETENGA las CUCHILLAS giratorias antes de elevar la plataforma de la cortadora o las alas
- DETENGA la cortadora, EXAMÍNELA y PRESTE ATENCIÓN A LOS SONIDOS antes de acercarse a la cortadora para asegurarse de que se haya detenido todo el movimiento giratorio. *PN MB01 SP*

## RIESGO DE FILTRACION DE ACEITE HIDRÁULICO DE ALTA PRESIÓN

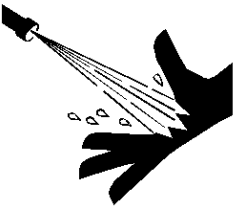
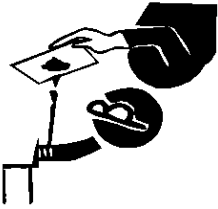
		
Penetración de aceite de alta presión en la piel	Erosión de la piel por el aceite de alta presión	Usar cartón para detectar filtraciones de aceite

**PELIGRO** PARA EVITAR LESIONES GRAVES O LA MUERTE POR PENETRACIÓN DE FILTRACIONES DE ACEITE HIDRÁULICO DE ALTA PRESIÓN:

- **NO OPERE** el equipo con filtraciones de aceite o combustible.
- MANTENGA todas las mangueras hidráulicas, líneas y conexiones en **BUEN ESTADO** y **AJUSTADAS** antes de aplicar presión al sistema.
- **LIBERE LA PRESIÓN HIDRÁULICA** antes de desconectar las líneas o trabajar en el sistema.
- **QUITTE** y reemplace la manguera si sospecha que tiene filtraciones. Solicite al distribuidor que verifique si hay filtraciones.

**LAS FILTRACIONES DE LÍQUIDO DE ALTA PRESIÓN PUEDEN NO SER VISIBLES.**

**AL VERIFICAR FILTRACIONES HIDRÁULICAS Y TRABAJAR CERCA DE LOS SISTEMAS HIDRÁULICOS:**

- **SIEMPRE USE** gafas de seguridad y guantes impermeables.
- **USE** papel o cartón para verificar si hay filtraciones.
- **NO USE** las manos o partes del cuerpo para detectar filtraciones.
- MANTENGA las manos y el cuerpo **LEJOS** de los orificios de clavijas y boquillas de eyección de fluido hidráulico. El fluido hidráulico puede causar gangrena si no es extraído quirúrgicamente de inmediato por un médico especializado en este tipo de lesiones. *PN HP01 SP*

# SEGURIDAD

## RIESGO DE ENREDO POR EL PTO

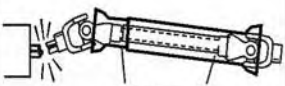
<p>Peligro de enredo No se acerque o toque ningún eje de transmisión de PTO giratorio</p>	
<p>Asegúrese de que el eje de PTO esté firmemente sujetado. No use un adaptador de PTO</p>	<p>PTO (Barra Gítorria)</p> 
<p>No opere la máquina si las cubiertas de PTO están dañadas o faltantes</p>	
<p>Asegúrese de que los ejes de PTO sean del largo adecuado</p>	

**▲ PELIGRO** MANTÉNGASE ALEJADO DE LAS LÍNEAS DE CONDUCCIÓN Y OTROS ELEMENTOS GIRATORIOS PARA EVITAR LESIONES GRAVES O LA MUERTE:

MANTÉNGASE LEJOS Y NO ACERQUE las manos, los pies y el cuerpo a las cuchillas giratorias, líneas de conducción y partes hasta que todos los elementos móviles se hayan detenido.

- **DETENGA** la cortadora, **EXAMÍNELA Y PRESTE ATENCIÓN A LOS SONIDOS** antes de acercarse a la cortadora para asegurarse de que se haya detenido todo el movimiento giratorio.
- **LOS ELEMENTOS GIRATORIOS SIGUEN ROTANDO** una vez apagada la PTO.

### PROTECCIÓN DE LA PTO:

PARA EVITAR LESIONES GRAVES O LA MUERTE POR ENREDO AL OPERAR EL IMPLEMENTO:

- **MANTENGA** instalados los protectores, las cubiertas integrales de las líneas de conducción y las cubiertas de entrada
- **NO OPERE** la cortadora si los protectores o cubiertas no están bien colocados o faltan.
- **REEMPLACE O REPARÉLOS** si faltan, están dañados o rotos
- **SIEMPRE REEMPLACE LOS PROTECTORES** que se han quitado para tareas de reparación o mantenimiento.

PARA EVITAR que la línea de conducción se rompa durante las operaciones:

- **VERIFIQUE** que la línea de conducción tenga el largo adecuado entre el eje de PTO y el eje de la caja de cambios del implemento.
- Las líneas de conducción demasiado cortas se pueden soltar o romper.
- Las líneas de conducción demasiado largas pueden tocar el suelo.
- Un ensamblaje telescópico de la línea de conducción que toque el suelo no se deslizará y se solidificará.
- Si la línea de conducción toca el suelo, puede atravesar los cojinetes de soporte y romper el eje de PTO.
- **EVITE** hacer curvas pronunciadas o elevar la cortadora a alturas que puedan hacer caer la línea de conducción.
- Lubrique los componentes telescópicos del eje de transmisión en forma semanal.

**COMUNIQUESE CON EL DISTRIBUIDOR** si la línea de conducción del implemento no coincide con el eje de PTO del tractor:

- **NO UTILICE UN ADAPTADOR DE PTO.**

El uso de un adaptador de PTO puede causar vibración excesiva, caída de objetos, fallas de las cuchillas y el implemento como consecuencia de la duplicación de la velocidad operativa. El aumento de la longitud de trabajo puede exponer áreas desprotegidas de la línea de conducción. *PN PE01 SP*

# SEGURIDAD

# SEGURIDAD

## RIESGO DE ATRAPELLO

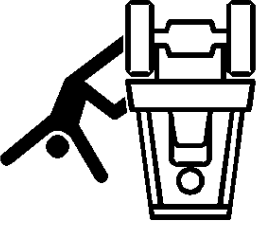

		
Riesgo de atrapello del operador	Riesgo de atrapello por caída del operador	Riesgo de atrapello por caída del operador

**PELIGRO** PARA EVITAR LESIONES GRAVES O LA MUERTE POR CAÍDA DEL TRACTOR O ATRAPELLO DEL EQUIPO:

- USE tractores equipados con SISTEMA ANTIVUELCO (ROPS) y CINTURONES DE SEGURIDAD para las operaciones de corte.
  - MANTENGA EL SISTEMA ROPS trabado en posición vertical.
  - SÓLO ENCIENDA el tractor sentado en el asiento del tractor.
  - SIEMPRE ABRÓCHESE el cinturón de seguridad al operar el tractor y los equipos.
  - SÓLO OPERE el tractor y el equipo sentado en el asiento del tractor.
  - NUNCA LLEVE A OTRAS PERSONAS en el tractor o implemento.
- AL SUBIR Y BAJAR DEL TRACTOR:**
- SÓLO suba o baje del tractor cuando éste y sus partes móviles estén detenidos.
  - APAGUE EL MOTOR Y LA TDF, coloque el freno de mano, descienda del implemento, espere a que se detengan todas las partes móviles y quite la llave antes de bajarse del tractor. *PN R001 SP*

# SEGURIDAD

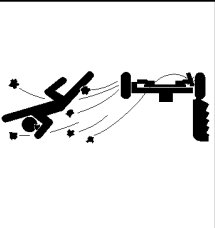
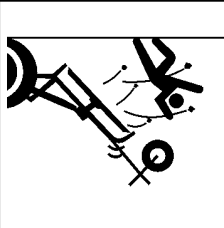
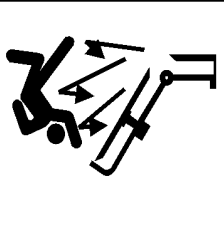
## RIESGO DE OBJETOS LANZADOS Continuado

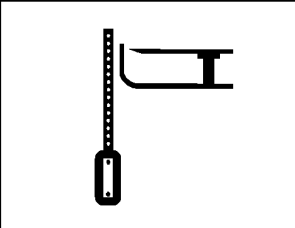
	Peligro de objetos lanzados por la cortadora
	Objetos lanzados desde cortadora elevada
	Objetos lanzados desde cortadora elevada
	Inspeccione el área. Quite los objetos extraños
	No permita que las cuchillas entren en contacto con objetos sólidos



### OPERACIÓN DE LA CORTADORA:

- NO exceda la capacidad de corte nominal de la cortadora, ni corte elementos que no sean vegetación.
- **USE CABINAS DE TRACTOR CERRADAS** cuando haya dos o más cortadoras operando en un mismo sector.
- No opere la cortadora en áreas susceptibles al ataque de abejas o insectos, salvo que **USE PRENDAS PROTECTORAS** o una cabina de tractor cerrada.
- **AJUSTE** las secciones de la cortadora o la ala cercana y paralela al suelo sin exponer las cuchillas
- **AJUSTE LA ALTURA** de corte para **EVITAR EL CONTACTO DE LAS CUCHILLAS** con objetos sólidos, como alambres, piedras, postes, cordones, guardarrailles y obstrucciones fijas.
- **NO** opere la cortadora con la(s) ala(s) elevada(s) o en posición de transporte.
- **DETENGA LA CORTADORA** de inmediato si las cuchillas entran en contacto con objetos pesados, estructuras fijas, guardarrailles de metal y estructuras de cemento:
  1. **LAS CUCHILLAS PUEDEN FALLAR** con el impacto y los objetos pueden ser arrojados a gran velocidad.
  2. **INSPECCIONE Y REEMPLACE** las cuchillas dañadas.
  3. **VERIFIQUE** el equilibrio del porta cuchillas y **REEMPLÁCELO** si está dañado.
- **NO** opere la cortadora en agua **PARA EVITAR** una posible **FALLA DE LAS CUCHILLAS**.
- **EVITE OPERAR LA CORTADORA** en reversa:
  1. **DETENGA EL PTO** y retroceda la cortadora.
  2. **DESCIENDA** la cortadora, encienda el **PTO** y corte hacia adelante.
- **DETENGA EL PTO** y las **CUCHILLAS** al elevar las alas o la cortadora a posición de transporte.
- **NO** encienda el **PTO** con la cortadora en posición de transporte.
- **DETENGA** la cortadora cuando se produzca **VIBRACIÓN EXCESIVA**:
  1. **DETENGA EL PTO Y EL MOTOR** del tractor.
  2. **INSPECCIONE** la cortadora para detectar la fuente de la vibración
  3. **REEMPLACE** toda parte dañada o las **CUCHILLAS** dobladas o dañadas. *PN T001-X-SP*

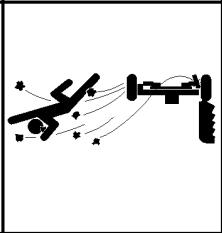
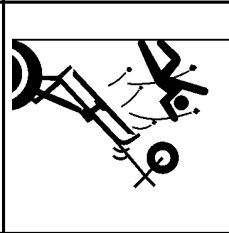
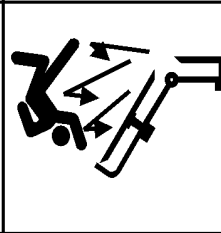

**SEGURIDAD**

**RIESGO DE OBJETOS LANZADOS**

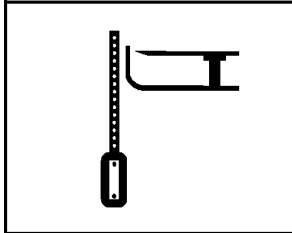
	Peligro de objetos lanzados por la cortadora
	Objetos lanzados desde cortadora elevada
	Objetos lanzados desde cortadora elevada
	Inspeccione el área. Quite los objetos extraños
	No permita que las cuchillas entren en contacto con objetos sólidos

LAS CORTADORAS GIRATORIAS PUEDEN ARROJAR OBJETOS A 90 METROS (300 PIES) O MÁS EN CONDICIONES ADVERSAS.



PARA EVITAR LESIONES GRAVES O LA MUERTE AL OPERADOR O TRANSEÚNTES COMO CONSECUENCIA DE OBJETOS ARROJADOS:

- **MANTENGA** a los transeúntes a 100 metros de distancia (300 pies)
- **NO OPERE LA CORTADORA SI HAY PERSONAS A MENOS DE 100 METROS(300 PIES), SALVO QUE:**
  - Todos los **PROTECTORES CONTRA OBJETOS ARROJADOS** estén colocados y en buen funcionamiento al operar la cortadora, entre los que se incluyen los deflectores frontales y traseros, los protectores de cadena, las bandas, las faldones laterales y las zapatas antideslizantes.
  - Las partes de la cortadora o la aia estén ajustadas cerca y paralelas al suelo, sin exponer las cuchillas.
  - Se ha inspeccionado el **ÁREA DE CORTE** y se han quitado todos los materiales extraños y residuos.
  - **LOS TRANSEÚNTES** estén en el interior de un vehículo cerrado.

**ANTES DE OPERAR LA CORTADORA, INSPECCIONE EL ÁREA PARA DETECTAR LA POSIBILIDAD DE OBJETOS QUE PUEDAN SER LANZADOS:**

- **QUITE** residuos, piedras, cables, alambres, objetos metálicos y cualquier otro objetos extraños del área. Los alambres, cables, sogas, cadenas y objetos metálicos pueden ser arrojados o salir desprendidos de la plataforma a gran velocidad.
- **1. MARQUE** los objetos que no se puedan quitar.
- **2. EVITE** estos objetos cuando use la cortadora.

**INSPECCION DEL ÁREA PARA DETECTAR HIERBA ALTA Y MALEZAS:**

- **INSPECCIONE Y quite** cualquier residuo oculto de gran tamaño.
- **PASE LA CORTADORA** a una altura intermedia
- **INSPECCIONE** y quite el residuo restante
- **PASE LA CORTADORA** a la altura final

**PROTECCIÓN CONTRA OBJETOS ARROJADOS DE LA CORTADORA:**

- **MANTENGA** todos los protectores contra objetos arrojados en su lugar y en buen funcionamiento al operar la cortadora, entre los que se incluyen los deflectores frontales y traseros, los protectores de cadena, las bandas, las faldones laterales y las zapatas antideslizantes.
- **NO OPERE LA CORTADORA** si falta algún protector contra objetos arrojados, o si éstos están dañados.

**DERECHO DE PASO (autopistas) CON LA CORTADORA**

- **UTILICE PROTECTORES DE CADENA DOBLES** para autopistas, derecho de paso, parques o cortes en cinturón verde donde pueda haber viviendas, vehículos o ganado dentro de los 100 metros (300 pies) de la cortadora.
- Ninguna protección ofrece una eficacia del 100% en la prevención de objetos arrojados. Para reducir la posibilidad de que se produzcan lesiones:

1. **MANTENGA LOS PROTECTORES DE LA CORTADORA**, los faldones laterales, las zapatas antideslizantes y las cuchillas en buen estado de funcionamiento.

2. **ELEVE LA ALTURA DE CORTE a 15 CM (6 PULGADAS)** como mínimo.
3. **INSPECCIONE EL ÁREA** con cuidado antes de pasar la cortadora para **ELIMINAR** el posible riesgo de **OBJETOS ARROJADOS**,

4. **NUNCA PERMITA QUE LAS CUCHILLAS EN MOVIMIENTO ENTREN EN CONTACTO CON OBJETOS SÓLIDOS** como alambres, piedras, postes, cordones, guardarralles o el suelo. **PN T001 SP**

# SEGURIDAD

## SEGURIDAD DE CONECTAR O DESCONECTAR IMPLEMENTO

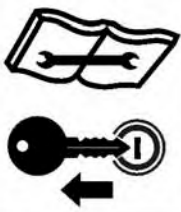
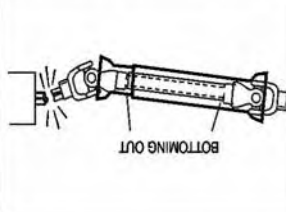
 <p>Detenga el tractor Quite la llave Lea el Manual</p>	 <p>Lesión opresiva entre tractor e implemento</p>	 <p>Lesión aplastante por caída de ala</p>	 <p>PTO (Barra Gítoria) Asegúrese de que el eje de TDF esté firmemente ajustado al tractor</p>	 <p>Asegúrese de que el eje de TDF sea del largo adecuado</p>
------------------------------------------------------------------------------------------------------------------------------------------------------	------------------------------------------------------------------------------------------------------------------------------------------------	---------------------------------------------------------------------------------------------------------------------------------------	---------------------------------------------------------------------------------------------------------------------------------------------------------------------------------------------------	----------------------------------------------------------------------------------------------------------------------------------------------------------

**PELIGRO** PARA EVITAR LESIONES GRAVES O LA MUERTE POR APLASTAMIENTO POR EL TRACTOR O IMPLEMENTO:

- **AL DAR MARCHA ATRAS** el tractor hacia el enganche del implemento:
- **NO PERMITA QUE HAYA PERSONAS** entre el tractor y el implemento
- **ANTES de conectar y desconectar el enganche del implemento:**
  - **APAGUE EL MOTOR DEL TRACTOR**, coloque la palanca en "estacionar", ponga el freno de mano y saque la llave.
  - **Al conectar y desconectar el enganche del implemento:**
    - **NO** se agache o camine debajo de la cortadora o la ala en posición elevada.
    - **USE el GATO** con lengüeta para elevar lengüetas de implementos pesados a fin de controlar el movimiento de la lengüeta del implemento.
    - **EVITE** recargar el gato para evitar una falla de este y una lesión al operador.

### AL CONECTAR LA LINEA DE CONDUCCIÓN DEL IMPLEMENTO:

- **PARA EVITAR que la línea de conducción se rompa durante las operaciones:**
  - **VERIFIQUE** que la línea de conducción tenga el largo adecuado entre el eje de **PTO** y el eje de la caja de cambios del implemento.
  - Las líneas de conducción demastado cortas se pueden soltar o romper.
  - Las líneas de conducción demastado largas pueden tocar el suelo.
  - Un ensamble telescópico de la línea de conducción que toque el suelo no se deslizará y se solidificará.
  - Si la línea de conducción toca el suelo, puede atravesar los cojinetes de soporte y romper el eje de **PTO**.
- **COMUNIQUESE CON EL DISTRIBUIDOR** si la línea de conducción del implemento no coincide con el eje de **TDF** del tractor:
- **NO UTILICE UN ADAPTADOR DE PTO.**
- El uso de un adaptador de **PTO** puede ocasionar:
  - Vibración excesiva, caída de objetos, fallas de la hoja y el implemento como consecuencia de la duplicación de la velocidad operativa.
  - Mayor extensión de trabajo, lo que deja expuestas áreas desprotegidas de la línea de conducción e implica el riesgo de enredo con otros objetos.



### ANTES DE QUITAR LAS TRABAS DE RETENCIÓN DE LAS ALAS:

- **CONECTE** las mangueras al tractor
- **LENE** los cilindros de las alas con lubricante
- **MANTENGA** a los transeñales lejos del área antes de operar las alas
- **DESCIENDA LAS ALAS** de manera lenta y cuidadosa.

**NO conecte la cortadora a un tractor con la TDF directamente conectada a la transmisión del tractor. PN CD01 SP**

# SEGURIDAD

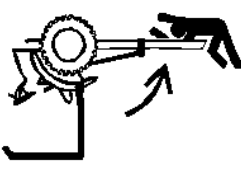
## RIESGO DE APLASTAMIENTO

				
Lesión aplastante por caída de ala	Lesión aplastante por caída de implemento	Siempre utilice cinturón de seguridad	Trabe el sistema ROPS (antivuelco) en la posición vertical	Lesión aplastante por vuelco

**▲ PELIGRO** PARA EVITAR UNA LESIÓN GRAVE O LA MUERTE POR CAÍDA DEL TRACTOR, O EL APLASTAMIENTO, VUELCO Y APLASTAMIENTO DE UN EQUIPO POR LA CAÍDA DE UNA ALA O UN IMPLEMENTO:

- USE tractores equipados con SISTEMA ANTIVUELCO (ROPS) y CINTURONES DE SEGURIDAD para las operaciones de corte.
- **MANTENGA EL SISTEMA ROPS** trabado en posición vertical.
- **SIEMPRE ABROCHESE** el cinturón de seguridad al operar el tractor y los equipos.
- **SOLO OPERE** el tractor y el equipo sentado en el asiento del tractor.

### AL ELEVAR O DESCENDER LAS ALAS:

- Eleve o descienda las alas **SÓLO CUANDO ESTÉ SENTADO** en el asiento del tractor, con el cinturón de seguridad ajustado.
- Eleve o descienda las alas **SÓLO** cuando la lengüeta del implemento esté firmemente ajustada a la barra de tracción del tractor.
- **PARA EVITAR A LOS TRANSEUNTES FUERA** del área de operación **PARA EVITAR** accidentes por aplastamiento.
- **MANTENGA** suficiente espacio libre alrededor de los implementos y alas **PARA EVITAR** el contacto con edificios o cables elevados.

Los equipos **ELEVADOS** se pueden caer por fallas mecánicas o hidráulicas o por un movimiento inesperado de la palanca de control.

**▲ ADVERTENCIA**

- **PARA EVITAR LA CAÍDA DEL EQUIPO** al trabajar cerca o debajo de las alas, los componentes e implementos elevados por un enganche de tractor de 3 puntos:
- **SUJETE CON FIRMEZA** o bloquee en posición vertical todos los equipos, alas y componentes elevados.
- **BLOQUEE EN POSICIÓN VERTICAL** y sujete con firmeza el equipo antes de poner las manos, los pies o el cuerpo debajo de los equipos o componentes elevados.
- **MANTENGA A LOS TRANSEUNTES LEJOS** de las alas dobladas hasta que estén bloqueadas o trabadas en posición vertical.

**AL ESTACIONAR** el implemento y el tractor:

- **DESCIENDA** el implemento, **TRABE** o **BLOQUEE** las partes elevadas antes de alejarse del equipo.
- **NUNCA** deje un implemento sin atención en posición elevada.

**▲ ADVERTENCIA**





- **NUNCA DEJE** que los niños jueguen sobre el tractor o los implementos, ni en sus alrededores.
- **AL DESENGANCHAR EL IMPLEMENTO:**
- **DESCIENDA** el implemento, **TRABE** o **BLOQUEE** las partes elevadas antes de alejarse del equipo.
- **USE** el gato de la lengüeta para controlar el movimiento de la lengüeta del implemento.
- **USE** el **GATO** de la lengüeta para elevar lengüetas de implementos pesados.
- **EVITE** recargar el gato para evitar falla al gato y una lesión al operador.

### ANTES DE QUITAR LAS TRABAS DE RETENCIÓN DE LAS ALAS:

- **CONECTE** las mangueras al tractor.
- **LENE** los cilindros de las alas con lubricante.
- **MANTENGA** a los transeuntes lejos del área de funcionamiento de las alas.
- **DESCIENDA LAS ALAS** de manera lenta y cuidadosa. *PN CH01 SP*

# SEGURIDAD

## SEGURIDAD DEL OPERADOR

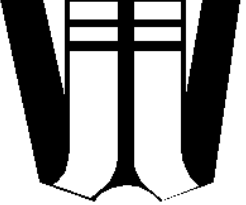
	Lea con atención el Manual del Operador
	Siempre use gafas de seguridad
	Use casco y calzado protector
	Nunca consuma drogas o alcohol mientras opera el equipo
	Utilice chaleco de seguridad al operar en o cercas de carreteras

PARA EVITAR LESIONES GRAVES O LA MUERTE, SIGA LAS SIGUIENTES INSTRUCCIONES:



- **LEA, COMPRENDA Y SIGA** las instrucciones del Manual del Operador, al igual que las Advertencias y Mensajes de Seguridad.
- **USE GAFAS DE SEGURIDAD**, calzado protector, casco, protección auditiva y guantes al operar o reparar el equipo.
- **USE** un aparato de respiración apropiado al operar en condiciones polvorientas a fin de evitar contraer enfermedades respiratorias.
- **NO USE** prendas sueltas o joyas que se puedan enredar con las partes giratorias y causar una lesión.
- **NO CONSUMA DROGAS** o **ALCOHOL** antes o durante la operación del equipo.
- **NO PERMITA** que nadie opere el equipo bajo los efectos negativos de las drogas o el alcohol.
- **CONSULTE** a un médico para conocer los efectos desfavorables de la medicación sobre los sentidos.
- **MANTÉNGASE ALERTA**, la operación prolongada puede causar fatiga. **HAGA UNA PAUSA y DESCANSE.**

## SEGURIDAD DE OPERACIÓN GENERAL

- **CONDICIONES DE VISIBILIDAD AL USAR LA CORTADORA:**
- **OPERE LA CORTADORA CON LUZ SOLAR** o con luz que aporte una visibilidad nítida de más de 90 metros (100 yardas).
- **DEBE PODER VISUALIZAR e** identificar transeúntes, terrenos empinados, pozos, desniveles, obstrucciones elevadas, cables de alimentación, residuos y objetos extraños.
- **VELOCIDAD RESPECTO AL SUELO AL USAR LA CORTADORA:**
- El rango de **VELOCIDAD NORMAL** es de entre 2 y 5 millas por hora.
- **AJUSTE LA VELOCIDAD DE CORTE** según las condiciones del terreno y el tipo de césped, la densidad y la altura del corte.
- **REDUZCA LA VELOCIDAD DE CORTE** al acercarse a inclinaciones empinadas, pozos, desniveles, obstrucciones elevadas, cables de alimentación y para evitar residuos y objetos extraños.

## INFESTACIÓN CON INSECTOS

- No opere en áreas susceptibles al ataque de abejas o insectos, salvo que **USE PRENDAS PROTECTORAS** o una cabina de tractor cerrada.

## VELOCIDAD DE PTO:

- **NO EXCEDA LA VELOCIDAD DE PTO NOMINAL DEL IMPLEMENTO**
- **EVITE** superar las velocidades nominales de PTO, porque puede causar roturas en la línea de conducción o fallas de las cuchillas.
- **SEÑALES DE SEGURIDAD:**
- **REEMPLACE** cualquier señal de seguridad faltante, dañada o ilegible. *PN 0501 SP*

# SEGURIDAD

## SEGURIDAD

### INSTRUCCIONES DE SEGURIDAD Y PRÁCTICAS GENERALES

El mejor operador es un operador cuidadoso. La seguridad es de importancia fundamental para el fabricante, y también debería serlo para el propietario u operador. La mayoría de los accidentes se pueden evitar prestando suma atención al equipo, al ambiente circundante, y tomando algunas precauciones. La primera sección de este manual incluye una lista de Mensajes de Seguridad que deben observarse para contribuir a la protección del operador y otras personas frente a lesiones o la muerte. Lea con atención estos Mensajes de Seguridad antes de ensamblar, operar o reparar este implemento. Este equipo sólo debe ser operado por personas que hayan leído el manual, responsables y calificadas, que sepan cómo hacerlo de manera responsable.



El Símbolo de Alerta de Seguridad se utiliza en combinación con una Señal Verbal, tal como la que se muestra a continuación, en todo este manual y en los autoadhesivos adheridos a los equipos. El Símbolo de Alerta de Seguridad significa:

**“¡ATENCIÓN! MANTÉNGASE ALERTA! SU SEGURIDAD ESTÁ EN JUEGO!”** El Símbolo y la Señal Verbal tienen el objetivo de advertir al propietario/operador sobre un riesgo inminente y el grado de lesión que se puede producir al operar este equipo.

**Adopte todas las medidas habituales para trabajar en forma segura y, sobre todo, recuerde que la seguridad depende de USTED. Sólo USTED puede impedir una lesión grave o la muerte a causa de prácticas no seguras.**

Indica una situación peligrosa inminente que, de no ser evitada, **OCCASIONARÁ** la **MUERTE O UNA LESIÓN MUY GRAVE.**



Indica una situación peligrosa inminente que, de no ser evitada, **PODRÍA OCCASIONAR** la **MUERTE O UNA LESIÓN MUY GRAVE.**



Indica una situación peligrosa inminente que, de no ser evitada, **PODRÍA OCCASIONAR** **UNA LESIÓN MENOR.**

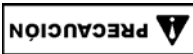

Identifica instrucciones o procedimientos específicos que, de no observarse estrictamente, podrían ocasionar daños o la destrucción de la maquinaria, los accesorios o el entorno.



**NOTA:** Identifica aspectos de particular interés para lograr una operación o reparación más eficiente y conveniente.



**LEA CON ATENCIÓN Y RESPETE** los siguientes Mensajes de Seguridad. Si no se siguen cuidadosamente las advertencias e instrucciones indicadas en este Manual y en los Mensajes de Seguridad del implemento, se pueden producir lesiones graves o la muerte. Siempre siga las instrucciones de este manual y use el sentido común para evitar situaciones peligrosas.

**NOTA:** Si desea obtener una traducción de esta sección de seguridad en alguno de los siguientes idiomas, comuníquese con: *Translations, a la dirección 1502 E. Walnut Street Seguin, TX 78155; Fax: (830) 372-9529; La Sección de Seguridad está disponible en español, portugués, francés, alemán, ruso. PN 6501 SP*

# SECCIÓN DE SEGURIDAD

Sección de Seguridad 1-1



# Instrucciones de operaciones antes de la entrega del DISTRIBUIDOR al CLIENTE

El distribuidor deberá informar al comprador de este producto las condiciones, disposiciones y procedimientos de garantía aplicables; informar la responsabilidad del comprador de capacitar a sus operadores para la operación segura; revisar el contenido del Manual del Operador, incluido el equipo de seguridad, la operación segura y el mantenimiento; y revisar las Señales de Seguridad que se encuentran en el implemento (y en el tractor, de ser posible).

- **IMPLEMENTOS:** He explicado que los deflectores, protectores de cadena o faldones sólidos se deben mantener en buenas condiciones de reparación y se deben instalar, excepto en zonas donde personas, vehículos, ganado u otros bienes no corran peligro por objetos arrojados, y en los casos en que dichos equipos de seguridad impedirían un desempeño razonable de la cortadora en su tarea asignada.
- **LINEAS DE CONDUCCIÓN:** Me he asegurado de que todos los protectores de líneas de conducción, de caja de engranajes y otros están en buenas condiciones de reparación y firmemente sujetados para prevenir lesiones por enredo u objetos arrojados.
- **MÁQUINAS HIDRÁULICAS:** He explicado la necesidad de usar aceite hidráulico limpio, cambiar los filtros según las instrucciones, detener filtraciones, prevenir daños por operar con aceite demasado caliente, cuidar las mangueras, usar mangueras del tipo correcto, mantener la presión operativa especificada y prevenir el posible riesgo de que el aceite penetre en la piel.
- **IMPLEMENTOS PLEGABLES:** He explicado que no es posible proteger contra objetos arrojados cuando el cabezal está elevado del suelo y que el operador es responsable de verificar que no existan personas en las inmediaciones. He explicado que el brazo o cabezal de cortadora elevado puede entrar en contacto con obstrucciones elevadas y dañar cables y líneas telefónicas, y posiblemente causar lesiones. He explicado que el brazo o cabezal extendido, o el brazo retirado, puede entrar en contacto con cables de alimentación y causar lesiones o la muerte por electrocución, y que el operador es responsable de evitar dichos riesgos.

## SERVICIO ANTES DE LA ENTREGA VERIFIQUE Y AJUSTE O LUBRIQUE SEGUN SEA NECESARIO

Consulte los detalles en el Manual del Operador  
Inspección realizada – Garantía y procedimientos de seguridad explicados – Instalación realizada

<input type="checkbox"/>	<b>LUBRICACIÓN E HIDRÁULICA</b>	<input type="checkbox"/>	Caja de engranajes (niveles de aceite)
<input type="checkbox"/>		<input type="checkbox"/>	Nivel de aceite hidráulico (tanque externo)
<input type="checkbox"/>		<input type="checkbox"/>	Nivel de aceite hidráulico (no retorcidas y ajustadas)
<input type="checkbox"/>		<input type="checkbox"/>	Propulsor de bomba frontal (conjunto ajustado y eje bien alineado)
<input type="checkbox"/>	<b>CORTADORA</b>	<input type="checkbox"/>	Pernos de husillo y motor bien ajustados
<input type="checkbox"/>		<input type="checkbox"/>	Nivel de aceite del husillo
<input type="checkbox"/>		<input type="checkbox"/>	Pernos de porta cuchillas bien ajustados/pasadores de retención colocados
<input type="checkbox"/>		<input type="checkbox"/>	Nivel y altura de corte de la cortadora ajustados
<input type="checkbox"/>		<input type="checkbox"/>	Cojinetes del eje de corte lubricados
<input type="checkbox"/>		<input type="checkbox"/>	Todas las piezas metálicas bien ajustadas
<input type="checkbox"/>		<input type="checkbox"/>	Presión de aire y neumáticos/tuercas de rueda (bien ajustadas)
<input type="checkbox"/>		<input type="checkbox"/>	Cojinetes de rueda (verificar, engrasar y hacer carga previa)
<input type="checkbox"/>	<b>ACCESORIOS E INSTALACIÓN</b>	<input type="checkbox"/>	Deflectores frontales y traseros
<input type="checkbox"/>		<input type="checkbox"/>	Accesorios de trituración
<input type="checkbox"/>		<input type="checkbox"/>	Sentido de giro de las hojas correcto
<input type="checkbox"/>		<input type="checkbox"/>	Vigas y brazos de eje
<input type="checkbox"/>		<input type="checkbox"/>	Lengüeta y barras de control (instaladas y ajustadas)
<input type="checkbox"/>		<input type="checkbox"/>	Todos los pernos, pasadores y tuercas (ajuste correcto)
<input type="checkbox"/>	<b>CONEXIONES DE CORTADORA A TRACTOR</b>	<input type="checkbox"/>	Longitud de barra de enganche (verificar y fijar)
<input type="checkbox"/>		<input type="checkbox"/>	Pivote y conexiones de bastidor en A
<input type="checkbox"/>		<input type="checkbox"/>	Barras de control (ajustadas iguales)
<input type="checkbox"/>		<input type="checkbox"/>	Altura de eje (ajustar)
<input type="checkbox"/>		<input type="checkbox"/>	Altura de corte (ajustar)
<input type="checkbox"/>		<input type="checkbox"/>	Verificación de pre-operación de kit de montaje
<input type="checkbox"/>		<input type="checkbox"/>	Aleta de cortadora (ajustar nivel con el centro)
<input type="checkbox"/>		<input type="checkbox"/>	Aleta de cortadora (verificar operación de elevación correcta)
<input type="checkbox"/>		<input type="checkbox"/>	Líneas de conducción C.V. (verificar radio de giro máx.)
<input type="checkbox"/>		<input type="checkbox"/>	Enganche de tracción (ajuste de altura)
<input type="checkbox"/>		<input type="checkbox"/>	Piezas metálicas de montaje bien ajustadas
<input type="checkbox"/>	<b>ELEMENTOS DE SEGURIDAD</b>	<input type="checkbox"/>	Protectores (operación e instalación)
<input type="checkbox"/>		<input type="checkbox"/>	Embrague de línea de conducción (limitador de ajuste)
<input type="checkbox"/>		<input type="checkbox"/>	(ajustar y poner en marcha)
<input type="checkbox"/>		<input type="checkbox"/>	Autoadhesivos de seguridad (colocados)
<input type="checkbox"/>		<input type="checkbox"/>	Manual del Operador (entregado)
<input type="checkbox"/>		<input type="checkbox"/>	Protector de TDF del tractor (instalado)
<input type="checkbox"/>		<input type="checkbox"/>	Emblema S.M.V. (instalado de ser necesario)
<input type="checkbox"/>		<input type="checkbox"/>	Gato con lengüeta (instalación y operación)
<input type="checkbox"/>		<input type="checkbox"/>	Cadena de remolque de seguridad (instalada)
<input type="checkbox"/>		<input type="checkbox"/>	Manual de Seguridad de Línea de Conducción ADMA (entregado)
<input type="checkbox"/>		<input type="checkbox"/>	Manual de Seguridad de Cortadora AEM (entregado en porta manual)
<input type="checkbox"/>		<input type="checkbox"/>	Se mostró el Video de Seguridad de Cortadora AEM al comprador



**Bush Hog está dispuesto a suministrar un (1) Video de Prácticas de Seguridad para Cortadoras AEM**

Por favor enviar:

- Video de Seguridad para el Operador de Cortadoras AEM/FEMA – formato VHS
- Video de Seguridad para el Operador de Cortadoras AEM/FEMA – formato DVD
- Manual del Operador de la Cortadora
- Manual de Seguridad del Operador de la Cortadora AEM

Nombre del solicitante \_\_\_\_\_ Teléfono: \_\_\_\_\_

Dirección del solicitante \_\_\_\_\_

Ciudad \_\_\_\_\_

Estado \_\_\_\_\_

Código postal \_\_\_\_\_

Modelo de cortadora \_\_\_\_\_ Número de serie \_\_\_\_\_

Fecha de compra \_\_\_\_\_ Vendedor del distribuidor \_\_\_\_\_

Nombre del distribuidor \_\_\_\_\_ Dirección del distribuidor \_\_\_\_\_

Enviar por correo a:

AEM Video Services

1502 E. Walnut Street

Seguin, TX 78155

○ enviar por fax a:

(830) 372-9529

○ enviar por correo electrónico a:

AEMVideo@alamo-group.com



[www.algqr.com/bvs](http://www.algqr.com/bvs)

➤ **Sea Entrenado**  
antes de funcionar  
el cortacésped

➤ **Sea Vivo**

➤ **Sea Alerto**

➤ **Sea Seguro**

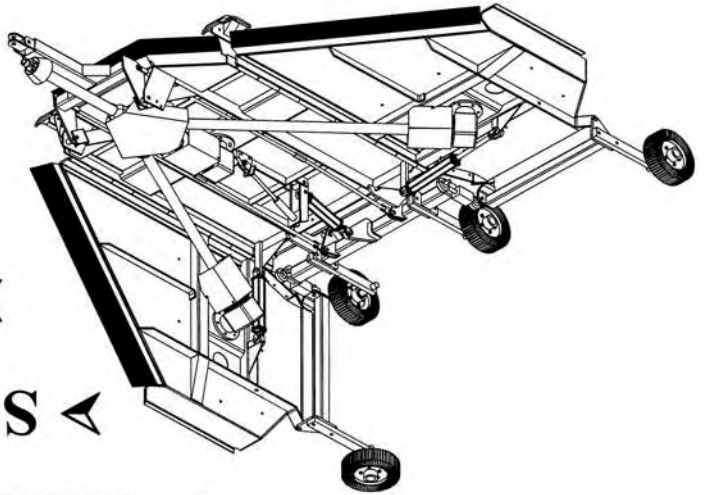

## **Entrenamiento de Seguridad** *Hace la Diferencia*

Bush Hog Image\_SP

A fin de reducir la tasa de accidentes y mejorar la operación segura de las cortadoras, *Bush Hog* se ha asociado con otros fabricantes de la industria para desarrollar el video y la guía de Prácticas de Seguridad para Cortadoras Industriales y Agrícolas AEM/FEMA.

El video explica a los operadores de tractores y cortadoras las prácticas seguras que deben adoptar cuando utilizan cortadoras industriales y agrícolas. Es importante que todos los operadores de cortadoras aprendan cómo operar sus equipos de corte y puedan reconocer los posibles peligros que pueden surgir al operar una cortadora. Este video, en conjunto con el manual del operador de la cortadora y los mensajes de advertencia que se encuentran en la cortadora, serán muy útiles para complementar este aprendizaje tan importante.

Es posible que su distribuidor autorizado de *Bush Hog* le haya mostrado este video y le haya entregado una copia en DVD cuando adquirió su cortadora. Si usted o algún operador de cortadora no vio el video: mire el video, lea este Manual del Operador, y complete la Guía del Video antes de operar su cortadora nueva. Si no comprende alguna de las instrucciones del video o del manual del operador, o si tiene alguna pregunta acerca de la operación segura, comuníquese con su supervisor, con el distribuidor o con *Bush Hog*. Si desea recibir una copia del video en VHS, envíe un mensaje de correo electrónico a [AEMVideo@alamo-group.com](mailto:AEMVideo@alamo-group.com) o un fax al (830) 372-9529, o envíe por correo una copia rellena del formulario que se encuentra al dorso de esta página a AEM VHS Video 1502 E Walnut Street, Seguin, TX 78155, y solicite la versión en VHS. Indique su nombre, dirección postal, modelo de cortadora y número de serie.

Cada uno de los operadores debe recibir capacitación para cada equipo (tractor y cortadora), comprender el uso previsto, y comprender los posibles peligros antes de operar el equipo.

La información y material mecionado en la información anterior junto con el Manual de Operador puede asistir en cumplir con los requisitos de OSHA para el entrenamiento anual del Operador.

### **REQUISITOS DE ENTRENAMIENTO DEL OSHA**

**Los siguientes requisitos de entrenamiento se an toma de el Título 29, código de la pieza de regulaciones federales 1928.57 (a) (6), [www.osha.gov](http://www.osha.gov)**

Instrucciones del operador. A la hora de la asignación inicial y por lo menos anualmente después de eso, el empleador mandará a cada empleado quien opera un tractor agrícola o implemento en las prácticas de operación segura y el mantenimiento de el equipo con el cual el empleado este, o estará implicado y de cualquier otras prácticas dictados por el ambiente laboral.

## Al propietario/operador/distribuidor

Este Manual del Operador es una parte esencial de la operación segura de esta máquina y se debe mantener con la unidad siempre. El implemento incluye un porta manual donde se puede guardar el manual de manera adecuada. Si el manual se extravía o se daña, puede solicitar otra copia sin cargo a un distribuidor autorizado de Bush Hog o descargarlo del sitio web de Bush Hog ([www.bushhog.com](http://www.bushhog.com)).

ANTES DE COMENZAR LEA, COMPRENDA Y SIGA la información incluida en este manual, el Manual de Seguridad de la Cortadora AEM y el manual del operador del tractor para conocer cómo operar la máquina y realizar tareas de servicio correctamente. De lo contrario, podría sufrir lesiones u ocasionar lesiones a terceros. Todos los implementos con partes móviles son potencialmente peligrosos. Cada esfuerzo ha sido hecho para asegurar que la máquina esté segura, pero los operadores deben evitar entrar en prácticas peligrosas y seguir las instrucciones escritas que son proporcionadas. El fabricante ha diseñado este implemento para ser usado con todos sus equipos de seguridad correctamente sujetos para minimizar la probabilidad de accidentes.

LA SEGURIDAD PRIMERO. Lea con atención la totalidad de la sección de seguridad de este manual antes de operar el equipo. No permita que nadie opere el equipo sin haber leído y comprendido la totalidad de este manual. Comuníquese con el distribuidor si necesita explicación sobre alguna instrucción que no haya comprendido del todo.

Los cuidados que brinda a su implemento Bush Hog determinarán en gran medida su satisfacción con el desempeño y la vida útil del equipo. Lea con atención y siga las instrucciones de este manual para comprender cabalmente su nuevo implemento, su uso previsto, y sus requisitos de servicio.

Todas las referencias que se hacen en este manual a derecha, izquierda, frontal, trasero, arriba y abajo corresponden a la perspectiva en el sentido del desplazamiento hacia delante con el implemento correctamente sujeto al tractor.

La información sobre repuestos se encuentra por separado en el Manual de Partes. Las cortadoras Bush Hog utilizan componentes del sistema equilibrados y coincidentes para porta cuchillas, cuchillas, ejes de corte, hojas, ganchos para hojas, rodillos, componentes de los engranajes, y cojinetes. Estas partes se fabrican y se prueban según las especificaciones de Bush Hog. Las partes compatibles no genuinas no siempre cumplen con estas especificaciones. El uso de partes no genuinas puede perjudicar el desempeño de la cortadora, anular la garantía y presentar un riesgo para la seguridad. Use partes genuinas Bush Hog para ahorrar dinero y maximizar la seguridad.

Para referencia futura, registre el número de modelo y el número de serie de BUSH HOG que ha adquirido.

Dueño	Fecha de compra:	Número de Serie
Distribuidor	Teléfono	Fecha de compra:

Placa de Número de serie

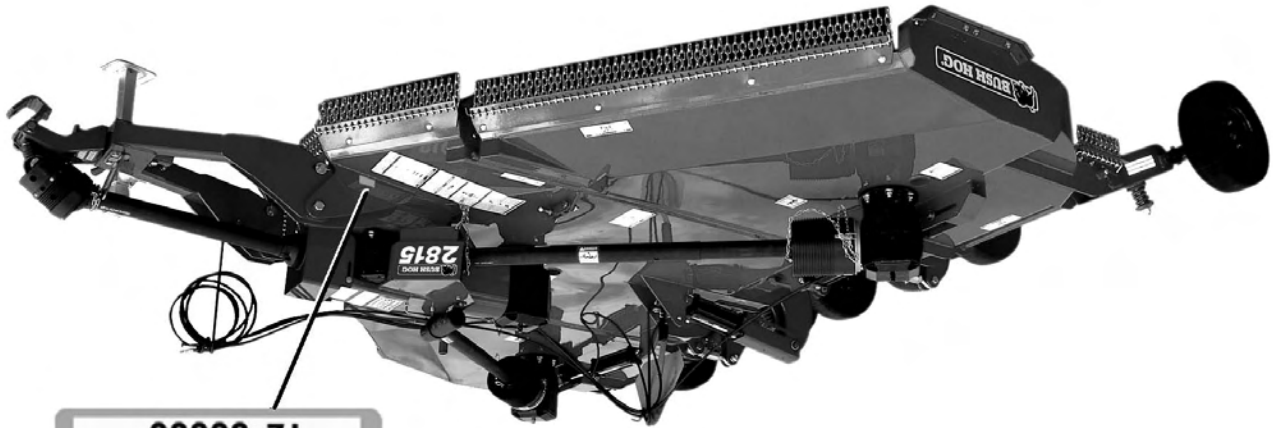
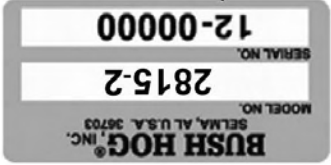

**2815-2 / 2810-2**  
**12815-2 / 12810-2**

**BUSH HOG®**



**CORTADORA/TRITURADORA GIRATORIA DE ELE-  
 VACION DEL NIVEL MECANICAS CON ALETA FLEXIBLE**

Publicado en 04/13

Parte no. 50071222

**MANUAL DE OPERADOR**

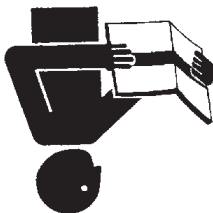
<p>Video de Seguridad</p>  <p><a href="http://www.algqr.com/bvs">www.algqr.com/bvs</a></p>	<p>Importantes instrucciones de operación y las instrucciones de seguridad se encuentran en el video Cortacésped Sobre Seguridad que se puede acceder instantáneamente en el internet en:  <a href="http://www.algqr.com/bvs">www.algqr.com/bvs</a></p>	 <p>Este Manual del Operador es una parte esencial de la operación segura de esta máquina y se debe mantener con la unidad siempre. LEA, ENTIENDA, y SIGA las Instrucciones de Seguridad y manual antes de operar el equipo. C01-Cover SP_B</p>
-------------------------------------------------------------------------------------------------------------------------------------------------------------------------------	-------------------------------------------------------------------------------------------------------------------------------------------------------------------------------------------------------------------------------------------------------------	--------------------------------------------------------------------------------------------------------------------------------------------------------------------------------------------------------------------------------------------------------------------------------------------------------------------------------------

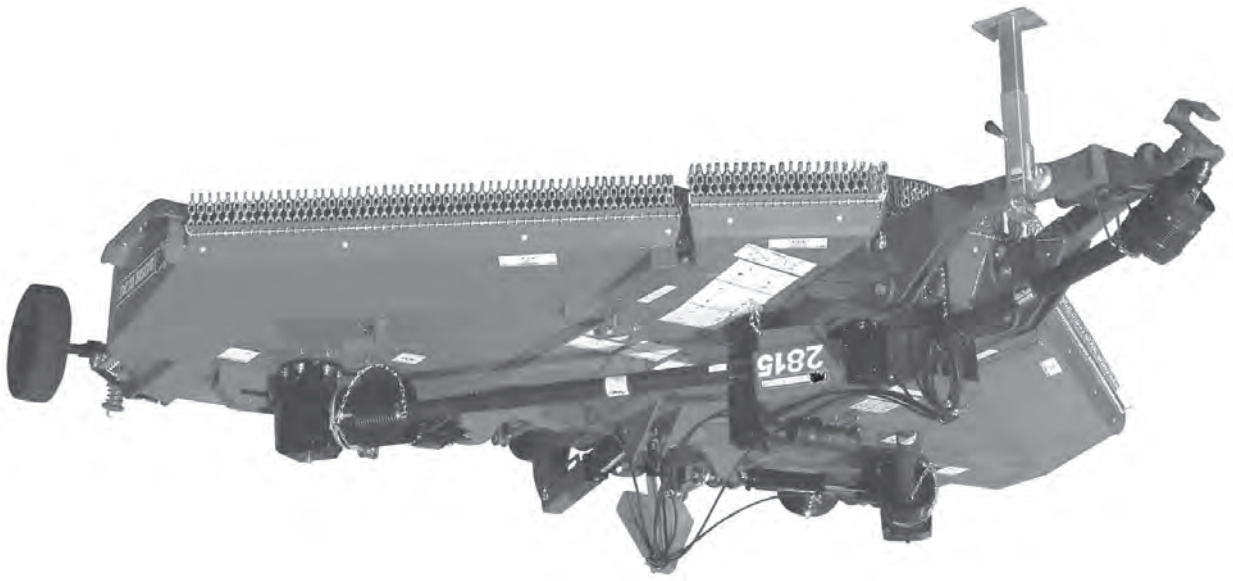

**BUSH HOG®**

2501 Griffin Ave.  
 Selma, AL 36703  
 334-874-2700

Correo electrónico: [www.bush-hog.com](http://www.bush-hog.com)

Página Web de Bush Hog



[www.algqr.com/bvs](http://www.algqr.com/bvs)

**ATTENTION!**  
 Read Manual  
 If you do not read  
 Spanish  
 please flip manual over in  
 english.



**MEMBER OF THE ALAMO GROUP**  
 ALWAYS ON THE CUTTING EDGE®



©2012 Alamo Group Inc.

\$0.00