



ALR2004GT - Operator Manual



- **Security**
- **Use**
- **Maintenance**

CONTENTS

WARRANTY	4
PRODUCT IDENTIFICATION	5
INTRODUCTION	6
SAFETY	7
SAFETY SYMBOLS ON THE APPLICATOR	7
HIGHWAY AND TRANSPORT OPERATIONS	10
ACCIDENT PREVENTION	11
<i>When hitching and unhitching of the applicator</i>	<i>11</i>
<i>During service</i>	<i>11</i>
<i>Hydraulic system</i>	<i>11</i>
<i>During operation</i>	<i>11</i>
TECHNICAL DATA – ALR2004GT	13
HITCHING PROCEDURE	14
ELECTRIC SELECTOR (OPTION)	17
UNHITCHING PROCEDURE	17
ADJUSTMENTS BEFORE OPERATION	17
<i>Setting to do before seeding</i>	<i>17</i>
SCALE MONITOR CALIBRATION (OPTION)	18
<i>Programming procedure</i>	
DIGITAL AREA COUNTER CALIBRATION (OPTION)	19
<i>Programming procedure</i>	
IN FIELD START-UP	21
APPLICATOR START-UP	23
CALIBRATION PROCEDURE	
<i>ALR2004GT – 18 meter (kg/ha)</i>	<i>24</i>
<i>ALR2004GT – 60 feet (lbs/acre)</i>	<i>25</i>
SERVICE ON THE APPLICATOR	26
<i>Cleaning</i>	<i>26</i>
<i>Beginning of the season maintenance</i>	<i>26</i>
<i>Storage and end of season maintenance</i>	<i>27</i>
<i>Lubricants and volumes</i>	<i>27</i>
<i>Lubrication of the blower’s gear box</i>	<i>27</i>
<i>Belt tension</i>	<i>27</i>
<i>Variable Transmission fluid</i>	<i>28</i>
<i>Repairing or removing the metering shaft</i>	<i>28</i>
<i>Wheel hub</i>	<i>29</i>

LUBRICATING (GREASE)	31
LUBRICATING (OIL)	32
OTHER MAINTENANCE	32
BOLTS TORQUE CHART	33
CONVERSION CHART	34

WARRANTY INFORMATION

In this document, “the Company” refers to Industry Aulari Inc.

- 1) New applicators manufactured by the Company, free of manufacturing defects (labor and parts) are warranted for one (1) season of use from the date of delivery to the customer.
- 2) If the applicator or components thereof does not meet the terms of warranty presented in clause 1, the Company must solve the problem and make sure the applicator in operation conditions, at his option:
 - a) Repair defective parts or components;
 - b) Replace parts or defective components with new parts.
- 3) This warranty releases the Company from any liability for loss of profit, loss of time, loss of use, towing charge or other incidental or consequences resulting from a defect of the applicator.
- 4) All warranty claims must be written to the Company within 14 days of the defect, only these written claims will be considered by the Company.
- 5) All warranty claims must be made by the original purchaser of the applicator.
- 6) The warranty will become void if:
 - a) Parts which are not manufactured by, provided by or approved by the Company are installed and used on the applicator;
 - b) Repairs, non-approved by the company, are made on the applicator;
 - c) Custom modification on the applicator is made without the written approval of the Company;
 - d) The applicator is damaged in an accident;
 - e) The applicator is misused, overloaded or used for any application other than seeding and fertilization. Specifications and capacities in this manual represent the acceptable limits for the use of the applicator (refer to the Specifications section of this manual);
 - f) The maintenance is not done according to the recommendations and intervals specified in this manual.
- 7) The company will provide telephone consultation with a trained representative. If necessary and if the equipment is located in the general geographic area served by the company or by an authorized dealer, the company may send a technician to work on the equipment at the owner’s place or business. Equipment that requires service or repair at the company facility or authorized dealership must be transported or shipped to and from the company manufacturing facility of authorized dealership at the owner’s sole expense.
- 8) To request a service call paid by warranty, the owner must report defect to the company or an authorized dealer and request repair within the warranty term.
- 9) The Aulari dealer makes no warranty of its own and the dealer has no authority to make any representation on behalf of the Company, or to modify the terms or limitations of this warranty in any way.

PRODUCT IDENTIFICATION

Please complete the information below upon receipt of your applicator. Accurately record all the numbers to help tracing the equipment in case of an incident (fire, stolen ...). Your dealer also needs these numbers when you order parts. Please file this information in a secure place off the machine.

Serial number	
Model	
Number of rows	
Year of manufacture	
Delivery date	
Date of first use	
Accessories included	

Dealer information

Name _____

Adress _____

City/ Province/ Country _____

Phone _____

Fax _____

Email _____

Manufacturer information

Industrie **AULARI** Inc.
620 St-Roch, St-Barnabe Sud
(Quebec) Canada J0H 1G0
Phone. : 450 792-2126
Toll free : 1-877-892-2126 (only North America)
Fax : 450 792-2127
info@aulari.com
www.aulari.com

INTRODUCTION

This operator manual contains all the information's needed to make the adjustment and maintenance on your Aulari's pneumatic precision applicator.

This manual should be considered as a permanent part of your machine and should remain with the machine when you sell it.

Please read this manual before using the applicator and be sure to follow the operating and maintenance instructions. Also, make sure that all operators of the applicator did read this operating manual. In a way to prevent accidents, reduce repair costs and downtime. In addition, you will increase the productivity and longevity of your applicator. Always comply with all safety instructions present in this manual.

Industry Aulari Inc. will not accept liability for any damage or consequence resulting from non-respect with the guidelines in this operator's manual.

The operating instructions will guide you for a better control of your machine and will guide you to make better use and optimal maintenance.

The operator manual must be read by everyone who works with this applicator, whether for:

- ☞ the operation of the applicator (adjustments in the field) ;
- ☞ daily or seasonal maintenance ;
- ☞ the transporter of the applicator

The period of warranty coverage begins upon delivery of the distributor. A representative of the Company or the dealer will provide the adjustment

Read the Instructions, maintenance and security before the first use of the applicator.

Industry **Aulari** inc. reserves the right to modify technical data and illustrations in this document in order to improve the product.

SAFETY

Carefully read all safety messages in this manual and on your machine safety signs. Keep safety signs in good conditions. Replace missing or damaged safety signs. Be sure new equipment components and repair parts include the current safety signs. Replacements of safety signs are available from your dealer or manufacturer.

The level of risk is indicated by the following signal words.



A signal word - **DANGER** identifies the most serious hazards which can result in serious physical injury or death. This signal word is to be limited to the most extreme situations typically for machine components which, for functional purposes, cannot be guarded.

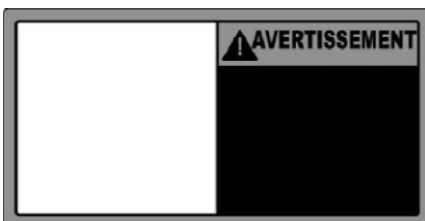

A signal word – **AVERTISSEMENT (WARNING)** indicates a potentially hazardous situation that: if it is not avoided, it could result in serious physical injury or death, and included hazards that are exposed when guards are removed. It may also be used to alert against unsafe practices.

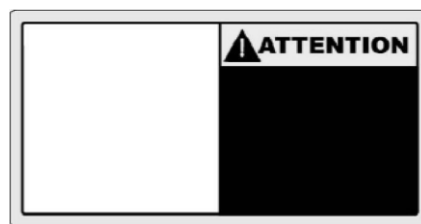

A signal word – **ATTENTION OR CAUTION** indicates a potentially hazardous situation, unsafe practice which could result in minor or moderate injury.



The safety information in this manual is denoted by the safety alert symbol:

SAFETY SYMBOL ON THE APPLICATOR



- Read the operator and maintenance manual before using the applicator.



- Use anchor points identified on the applicator for the carriage.



- Beware of under pressure escaping fluid. Relieve hydraulic system pressure before performing any works on the system.
- Relieve pressure before disconnecting hydraulic lines.
- Tighten all connections before applying pressure.
- Seek medical attention immediately if fluid is injected into skin.



- Never allow people on or near the equipment while it is moving.
- Do not climb on tank stairs or platform when equipment is in operation.

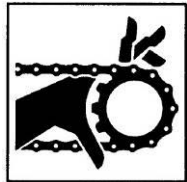

- Rotating fans and moving chains can sever digits. Keep hands, feet, hair and clothing away from moving parts.

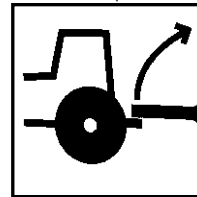

- Always keep all guards and shield in place
- Severing hazard.

- Avoid tipping cart, always fold the toolbar wings and lower down to the ground the equipment before unhitching the applicator.



- Remove guards only for adjustment or maintenance.
- Disconnect and lockout power source before adjusting or servicing.

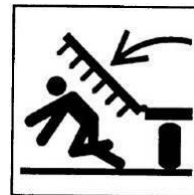

- Close and secure guards and shields before starting.

- Never climb onto applicator when it is not attached to an implement. Cart could tip, which may result in death or serious injury.

- Always keep a distance off the wings of the applicator when unfolding and folding.



- Never use the PTO without the security guard in place. Before maintenance or

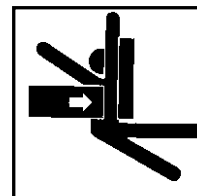

- Keep all persons and objects clear while any part of this equipment is in motion.



- Always install the cylinder locking devices before maintenance, repair or transport of the



- applicator.
- The jack may collapse under the weight of the applicator if hopper is full. Use the jack only to support the applicator when hopper is empty.



- Do not stand under the step when lower down.



- Never step in the hopper when the applicator is in operation

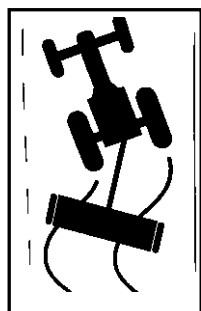

- Always follow the safety instructions when transporting the applicator. Pull the applicator with a tractor only. The maximum permitted speed on the road is 25 km/ h (16 mi / h).

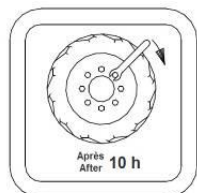

- Use proper warning lights
- Install safety chains.
- Tighten the wheel bolts after the first 10 hours of operation. Thereafter perform a torque check of

wheel nuts after 40 hours of use. See Section OTHER MAINTENANCE (page 59) in this manual.



- Check the tires daily. Make repairs when needed. Carefully check the tire pressure. See Section OTHER MAINTENANCE (page 59) for the correct pressure.
- Inflating or servicing tires can be dangerous.



To protect against death or serious injury, all labels must be on the machine and must be legible.

If labels are missing or cannot be read, call Industry Aulari at 1-450-792-2126 or 1-877-892-2126, or email info@aulari.com for replacement labels.

HIGHWAY AND TRANSPORT OPERATION

When it is necessary to travel on public roads, it is important to always follow the road safety rules in place.

It is the responsibility of the customer to know the lighting and marking requirements of the local highway authorities and to install and maintain the equipment to provide compliance with the regulations. Add extra lights when transporting at night or during periods of limited visibility.

Adopt safe driving practices:

- ☞ The maximum speed limit on road is 25 km / h (16 mph).
- ☞ Always use headlights, flashing warning lights, day and night, when transporting on a public roadway. Keep lighting and marking clean and visible to operators and other vehicles.
- ☞ Replace or repair any defective lighting or marking that has been damaged or lost.
- ☞ Safety chains should be used at all times. These chains must have a greater capacity than the combined weight of a loaded applicator and other equipment attached to it (minimum chain capacity recommended: 18300 kg - 40500 lb).
- ☞ Always use a proper tractor to operate the applicator. On the road, the tractor weight should always be 67% of the weight of the machine being towed.
- ☞ Never pull the planter on the road with a hopper filled more than 50% of its capacity.
- ☞ Do not allow any passengers in the hopper.

- ☞ In regards to warning lamps, maximum permissible transport widths and weights, check local governmental regulations.
- ☞ Serious injury or death can result from contact with electric lines. Use care when moving or operating this applicator near electric lines to avoid contact.
- ☞ Plan your route to avoid heavy traffic.
- ☞ Be a safe and courteous driver. Always yield to oncoming traffic in all situations.
- ☞ Watch for obstructions overhead and to the side while transporting.
- ☞ Never stand alongside of unit with engine running or attempt to start engine and/or operate machine while standing alongside of unit.
- ☞ Never leave running equipment attachments unattended.
- ☞ Always operate equipment in a position to provide maximum visibility at all times. Make allowances for increased length and weight of the equipment when making turns, stopping the units, etc.



When transporting, make sure that the stair of the platform is in raised position in order to not interfere with the components of the planter or tractor when it is in movement.

ACCIDENT PREVENTION

In addition to all the instructions, it is necessary to take special precautions to prevent accidents.

When hitching and unhitching the applicator

Some risks are present when connecting and disconnection of the applicator. Therefore observe the following:

- ☞ Install support device under the wheels to ensure that the applicator can not move when disconnected. Park the applicator on firm, level surface.
- ☞ The wings of the applicator must be lower down or locked in the folded position with the locking pins and hydraulic locks (valves).
- ☞ The toolbar should be lower down to the ground or locked in the raised position.
- ☞ When a device is installed on the rear lift, it must be lowered to the ground (except for application ramp, in which case, the locking cylinder device must be installed).
- ☞ Take the necessary precautions so that no one is nearby when you go backwards with the tractor and applicator.

During service

- ☞ Understand service procedure before doing service on the applicator. Keep area clean and dry.
- ☞ Place tractor transmission in park, turn tractor engine off and remove ignition key. Allow machine to cool.
- ☞ Lower equipment and tool bar to the ground and put the safety lock provided.
- ☞ Never lubricate, service, or adjust machine while it is moving.
- ☞ Keep hands, feet, and clothing from power-driven parts.

- ☞ Disengage all power and operate controls to relieve pressure.
- ☞ Securely support any machine elements that must be raised for service work.
- ☞ The fertilizer application parts (discs openers) present risks of injury.
- ☞ To avoid the risk of falling, never climb on rotatable parts (discs, gauge wheels, etc.).
- ☞ Observe the maintenance intervals specified in this operator's manual.

Hydraulic system

- ☞ Release pressure before disconnecting hydraulic or other lines. Tighten all connections before applying pressure.
- ☞ The hydraulic system of the applicator operates at high pressure. To prevent incidents search for leaks with a piece of cardboard. Protect hands and body from high pressure fluids.
- ☞ Hydraulic hoses can fail due to physical damage, kinks, age and exposure. Check hoses regularly. Replace damaged hoses.



To protect the operator and the other person who have to move around the applicator, always lower equipment to the ground and put the safety lock provided.

During operation

- ☞ Before starting, make sure that nobody is near the planter.
- ☞ Before unfolding the applicator, always check that there is enough open space for the deployment of all components (including wings and markers). Do not allow anyone to approach within 10 meters of the applicator when unfolding.

- ☞ All protective devices (guards and shields) must be in place at all times during the use of the applicator.
- ☞ The stair and platform of the hopper should be used only when the applicator is not in operation. It is forbidden to carry a passenger on the platform of the hopper.
- ☞ Nobody should get into the hopper of the applicator at all time, it could result in suffocation.

TECHNICAL DATA – ALR2004GT

Working width	12.19 m / 40 ft 18.29 m / 60 ft
Length	5.54 m / 7 ft 8 in
Height (top of the hopper)	2.13 m / 10 ft 2 in
Transport width	3.66 m / 12 ft 6 in
Hopper capacity	5 200 liters / 141 bushels
Total weight (empty hopper)	3 493 kg / 7 700 lbs
Tires (standard configuration)***	P54X31.00R26
Minimum horse power required****	75 – 120 KW / 100 – 160 cv

HITCHING PROCEDURE



When connection of the applicator, make sure that nobody are between the tractor and the applicator.

To reduce the risk of unexpected movement of the machine, set the tractor oil flow to the lowest level before connecting the applicator. Readjust subsequently for use in the field.

1. To level the applicator, the first hole of the adjustable hitch (starting from the ground) should be at 38 cm / 15 inches from the ground (For applicator with 380 / 80R38 tires) [Figure 1].

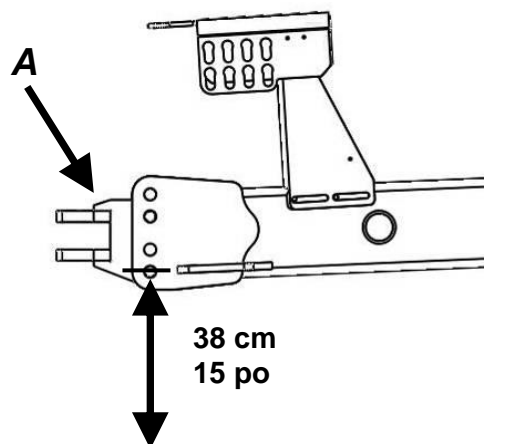
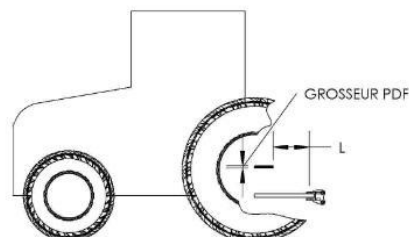

Figure 1

2. To adjust the height, use the holes offered on the adjustable hitch or reverse it for more configurations. [Figure 1, A]
3. If you need more height adjustment, reverse the tractor drawbar.
4. Adjust the draw bar of the tractor so that the mounting hole is located 35 to 46 cm (14 to 18 inches) from the end of the tractor PTO [Figure 1A]. To obtain a PTO shaft centered, this length should also be maintained

between the tip of the PTO and the center of the applicator mounting hole [Figure 1B].

- The accuracy of this adjustment will prevent the PTO shaft to squeal when turning.



GROSSEUR PDF	AJUSTER LA BARRE DE TIR À "L"
1 3/8-Z21 [35MM] (1000 TOURS)	16 POUCES [407 MM]
1 3/4-Z20 [45MM] (1000 TOURS)	20 POUCES [508 MM]

Figure 1A

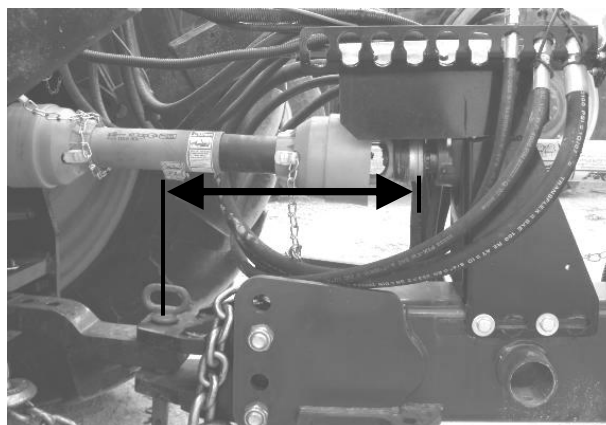

Figure 1B

6. Use a coupler hitch pin of 25 mm / 1 inch (minimum diameter). The length of the pin should be sufficient to pass through the two plates of the hitch hand. Use security pin to lock the coupler hitch pin.
7. Hook the safety chains to the tractor. Adjust the chain so that there is enough space to permit tight turns and to avoid interference with the coupling pin.

- Retract and remove jack from applicator. Jack support are located on the side of the tongue [Figure 2, A]



Figure 2

- Connect all hydraulic hoses to the tractor. Each hose is identified by a color code to determine its function [Figure 3].

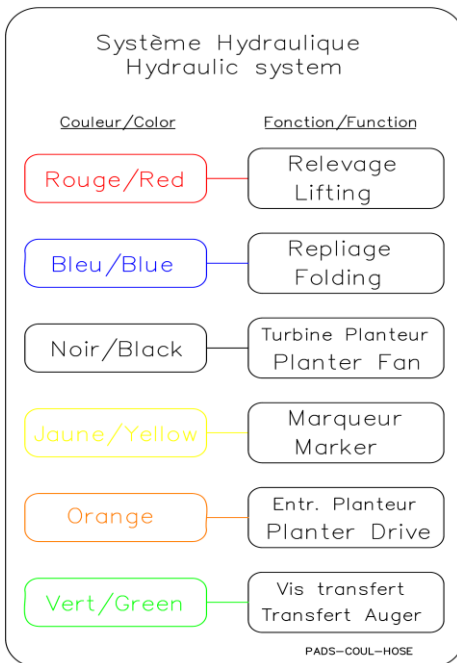

Figure 3

Inspect hoses before operation. Clean the hose coupler before connecting. Replace damaged hoses.

This applicator is equipped with multiple pressure control systems.



Modification or removal of these controls can cause serious injury or damage to the applicator. Do not remove the regulators; it will void the warranty of your applicator.

- Clean the splines of the tractor PTO shaft.
- Couple the PTO to the tractor shaft. If the tractor shaft is too long to fully retract when the tractor is turning, it is possible to slide PTO support on the tongue [Figure 4, A], loosen nuts [Figure 4, B] and move PTO support on tongue.

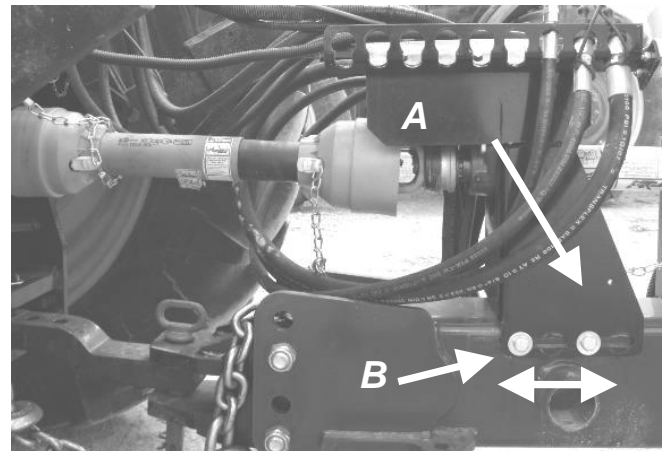

Figure 4

If adjustment of the PTO support is not enough, you must cut the PTO shaft. Refer to Figure 4A to meet the standards of the industry. For more details refer to the User Manual attached on the PTO.

NOTE: Cutting PTO shaft is applicable only for triangulated shaft and not for groove PTO shaft.

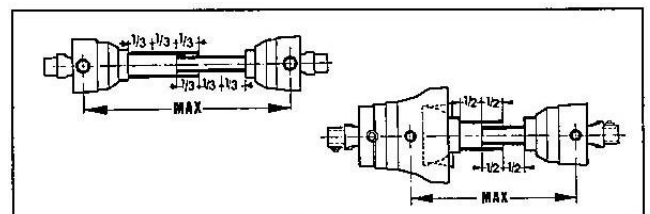

Figure 4A

12. Fix PTO chains to prevent device from turning when PTO is running.
13. Slowly, make a left turn then a right turn with tractor to verify if the lift arms do not interfere with the drive shaft and also verify if the length of the PTO is correct.
14. Connect the electrical outlet for lighting.
15. Depending of the options on your applicator, complete the connection of electronic cables in the cabin. [Figure 5 and 6]

To operate your electric options, please refer to the "ELECTRIC SELECTOR" in this section



Figure 5

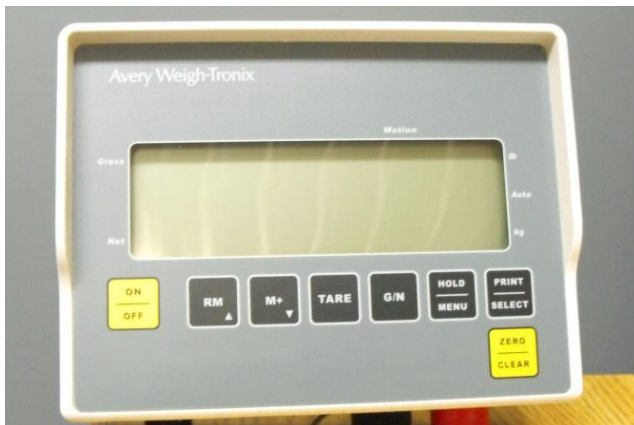

Figure 6

16. Once everything is connected, make sure everything is working well. Make correction if necessary.

ELECTRIC SELECTOR (Option)

If your applicator is equipped with an electric selector (Figure 6B), please follow the connection procedure below.

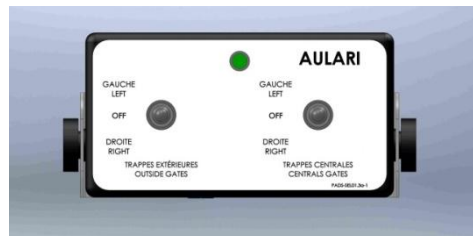

Figure 6B

1. Connect the switch box to the 12 VDC source of your tractor.

Make sure your tractor source connection works well with the ignition of the tractor. Otherwise, the green light on the switch box will illuminate when connected and stay on continuously, which will drain the batteries.



2. Connect the cables from your applicator to your switch box.
3. The different switches allow you to close the fertilizer gates depending of your needs. Select the gates on the switch box and activate the corresponding hydraulic outlets on the tractor remote.

Always place the switch in the OFF position when working in the field or during storage. This can drain your batteries or create a miss functioning of your fertilizer gates during operation.



AJUSTEMENTS BEFORE OPERATION

To optimise the performance of your applicator, it needs to be set right. It is suggested to do those settings before going to the field.

SETTINGS TO DO BEFORE FERTILIZING

1. Check the tires pressures according to the manufacturer specifications. If the tire pressure is too low, it can reduce tire longevity.
2. If your applicator has an integrated scale, make sure that the pre-program unit is the right one for you (kg or lb.). To modify the unit, refer to CALIBRATION section of this manual.
3. If your applicator use an acre calculator, make sure that the pre-program unit is the right one for you (hectare or acre). To modify the unit, refer to CALIBRATION section of this manual.



CALIBRATION OF THE SCALE (OPTION)

Configuration code #:
 Kg = 05184 (at 2 kg precision)
 Lb = 05280 (at 5 lb precision)
 Modification = 09280

Quick Programming Guide Numeric Entry Procedure

RM	Press this key to increment the value.
M+	Press this key to decrement the value.
<u>HOLD</u> MENU	Press this key to move the cursor.

1. Turn on the monitor.
2. Access the setup menu from the G/N mode. To do so, press and hold the **HOLD/MENU** key for three beeps (3 seconds), the release... **SET.PAS** is displayed.
3. Use the numeric entry procedure, see note up page, to enter the password **640**. Press **PRINT/SELECT** to accept it... **640** is shown
4. Press **PRINT/SELECT** once more... **CONFIG** is displayed.
5. Press the **PRINT/SELECT** key twice...
6. Use the numeric entry procedure, see note up page, to enter a new value. Press the **PRINT/SELECT** key to accept it... **CONFIG** is displayed.
7. Press **G/N** 2 time to accept the value, **BUSY** is displayed (few seconds) then the screen will be back to original model.

Note : If you want to change the unit on your monitor, you need to do the step 2 to 7 with the configuration code : **09280**. Then select the right unit.

Now, your scale monitor is calibrated. For any other questions, please consult the Scale monitor manual.

IMPORTANT : Your monitor needs to be in **GROSS** mode.



CALIBRATION OF THE AREA COUNTER (OPTION)

Before Starting

1. Select Units

US = Imperial SI = Metric

- Press and hold the **SPEED** and **+** buttons for about two seconds. The currently selected unit of measurement will be displayed; US = imperial or SI = metric.
- Use the **+** and **-** buttons to switch between units.
- Press **RPM** button to complete the change.

Note: All the calibration values and counters will be converted

2. Speed Sensor Calibration

The circumference calibration value is needed to calculate speed, distance and area; the Circ value is the distance traveled for each magnet pass across the Speed sensor.

- Make mark at the lowest point of the tire of the applicator (where it's in contact with the soil) then make a mark on the soil.
- Move forward with the applicator until the wheel made 10 revolutions. When the wheel made the 10th revolution, stop (when the mark on the tire is at the lowest point of the tire) Make a second line
- Measure the distance between the 2 marks (Either in metric or imperial, according to your choice).
- Divide that measure by 10.
- Press the **SPEED** button, the button light turns on (red light).
- Press the **Cal** button; the button lights begin flashing between the Speed and Cal buttons.
- Use the **+** and **-** buttons to change the displayed value to the calculated value.
- Press **RPM** button to complete the change.

- ☞ To verify your calibration, press the SPEED button and verify that the speed shown on your AGTRON monitor is the same speed shown on your tractor monitor and / or GPS monitor.
- ☞ If the speed shown on your AGTRON monitor is too high, you need to lower the calibration factor by doing the steps E, F, G of section 2.
- ☞ If the speed shown on your AGTRON monitor is too low, you need to raise the calibration factor by doing the steps E, F, G of section 2.
- ☞ If the circ value is changed, the distance total will change
- ☞ The maximum circ value is 393.6 inches or 999.9 centimeters.

3. Set The Implement Width

The width of the implement must be set for the Area counters to function. Follow this procedure to set the width of the implement.

- A. Press the **Area 1** button; the button light turns on (red light).
- B. Press the **Cal** button; the button lights will begin flashing between the Area 1 and Cal buttons.
- C. Use the **+** and **-** buttons to set the implement width in inches or centimeters; dependant on the selected units.

Note: Set the implement width to the working width to allow for overlap.

- D. Press the **RPM** button to complete the change.

☞ If the width value is changed, the Area 1 and Area 2 totals will change

☞ The maximum width value is 3936 inches or 9999 centimeters

Your Agtron area counters is ready!

Note: To clear the accumulated area, select desired area mode; Area 1 or Area 2. Press and hold the **-** button for 3 seconds.

IMPORTANT: The switch on top of the Monitor Head must be in Run position to do the accumulation of the two area counters and distance counter. Switch to the Hold position to stop the area and distance counters accumulating; the display will flash.

☞ On the ALR2304AM, the area counter is installed in a way you don't have to use the manual RUN/HOLD switch. In that case the only time you will use the manual switch is when the operator want to stop the counter on purpose.

IN FIELD START-UP

You need to do all the following steps to get the maximum of your applicator.

1. To set the transmission speed use the lever [figure 13, **A**]. For your info, usually when the dial is at 6 the rate should be around 225 kg/ha (200 lb./acre) (may vary depending on the density).
 2. The variable transmission optimum ratio is between 3 and 18 [figure 13A]. If you can't have your rate in the optimum range, you need to change the sprocket on the metering shaft [Figure 13B, **A**]. The sprocket installed at the factory has 20 teeth. Other sprocket can be found in the applicator's toolbox.
- ☞ If the rate is too low and the variable transmission's scale indicates 18, you need to change the 20 teeth sprocket on the metering shaft for 16 or 12 teeth. With a smaller sprocket, the RPM of the metering shaft will be higher so the rate will be higher.
- ☞ Please refer to CALIBRATION section for more information.



Figure 13A



Figure 13B

3. If you have the scale option, make sure to press the **ZERO/CLEAR** button [figure 14, **A**] before filling the hopper. For more information, please see CALIBRATION section of this manual.



Figure 13

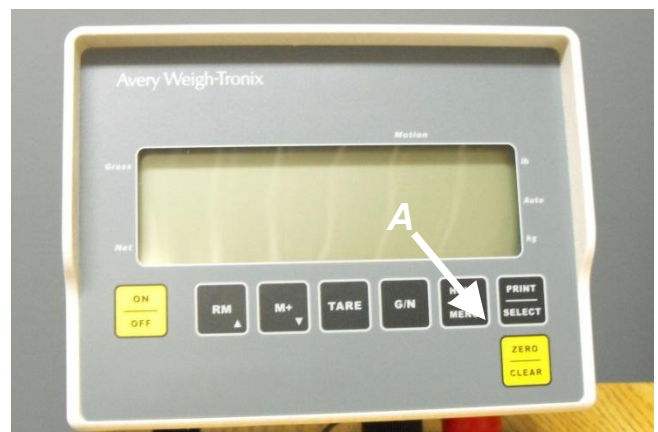

Figure 14

4. If you have the area counter option installed, make sure to reset to 0 the area by pressing « - » button [figure 15, **A**] a few seconds. For more information, please see CALIBRATION section of this manual.

To be more precise with your calibration you must always use the same set up. For an example, when you check your scale, always have the toolbar lower to the ground and the planter too.



Figure 15

5. To open the tarp of the hopper: rotate the wheel clockwise and lift the stopper lever. [Figure 15A, **A**]. Then let go the wheel downward. Roll up the tarp on itself by turning the wheel. Make sure to always be supported on the hopper. Roll the tarp until you reach the support at the other end of hopper. [Figure 15B, **A**].



Figure 15A

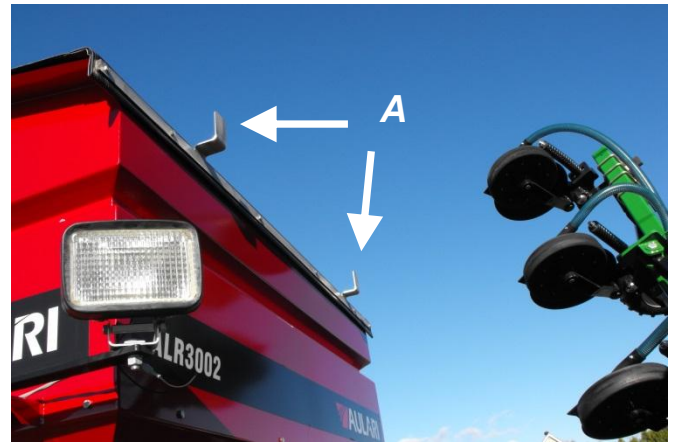

Figure 15B

6. To close the tarp, rotate the wheel the other way or you can use the strap stored on the left side of the hopper. [Figure 15C, **A**]. Roll the tarp on itself upward. Make sure the gear is aligned with the locking lever. When you're at the end of the hopper use the locking lever to bind the tarp.



Figure 15C

7. Before the first fill of your hopper, you have to make sure that: the grills are installed at the bottom and there isn't any clod on the grills.

APPLICATOR START-UP

The next steps must be done in order to reduce the risk of blocking or breakage.

1. Start the tractor PTO at low RPM.
2. Raise slowly the PTO RPM to: 800 RPM for the applicator equipped with a 1000 RPM PTO.
3. If your applicator is equipped with a scale, make sure to write down the weight and the area for the next calibration.
4. Lower the front toolbar and the rear equipment to the ground.



You need to make sure that there's enough free space around the applicator / equipment so the row marker can be unfold. Don't let anyone close the equipment when something is in movement.

5. Start to move forward. Raise the PTO to 1000 RPM according to your set up. The reading on the manometer [Figure 20A] must be between 30" to 36" of water for a REM BC172 CW blower [Figure 20B].



Figure 20 A



Figure 20B

- ☞ The REM HE blower should rotate at 5000 RPM when the tractor's PTO reaches 540 RPM or 1000 RPM.
 - ☞ The blower system has been calibrated to reach the maximum efficiency at or 1000 RPM.
6. Always keep an eye on the distribution mechanism to make sure it isn't block.

If you need to make some adjustments, please refer to ADJUSTMENT BEFORE OPERATION and IN FIELD STARTUP sections.

7. Verify frequently the distribution system. Points you need to check:
 - Metering shaft (Clean the shaft with the custom tool located in the toolbox)
 - Gates
 - Air manifold
- ☞ If the RPM of the PTO isn't high enough when the applicator is moving forward, the rate might be too high for the air pressure given in the system. This might cause a blocking in the distribution system.



Always keep the grills at the bottom of the hopper when it's filled with fertiliser. This is an essential part of the distribution system.

CALIBRATION PROCEDURE

Working width 18m (with contact wheel)

Working width : 18m
 Contact drive wheel (circumference) : 50.27po (1.27m)
 1 ha : 10 000m²

Calibration procedure (applicator without electronic scale)

1. Open the gate and install the calibration pan under the metering system.
2. Turn the contact drive wheel constantly for 10 rotations.
Or use the hand crank and turn for 28 rotations.
3. Weight the amount of fertilizer collected in the pan (in kg).
4. Multiply by the calibration factor 43.744 to obtain the application rate in kg/ha.
5. Adjust the transmission and if necessary repeating steps 2 to 4.

IMPORTANT : Be specific when you collect and weight the fertilizer, to ensure an accurate calibration .

Procedures	Data
We select an arbitrary value of rotation of the contact drive wheel (in this case 10 rotations).	1 rotation of the drive wheel = 1.27m 10 rotations of the drive wheel = 12.70m
Multiply the distance simulated by the working width to obtain an equivalence of 10 rotations of the contact drive wheel.	$12.70m \times 18m = 228.60m^2$
Divide a hectare by the simulated surface to obtain the calibration factor.	$10\ 000m^2 / 228.60m^2 = 43.744$
Multiply the amount of fertilizer in the pan by the calibration factor to obtain the application rate per hectare.	$4.5\ kg^{**} \times 43.744 = 196\ kg/ha$

**The more you do rotation of the drive wheel and the greater you collect fertilizer in the pan, more accurate will be your calibration rate.

** For the hand crank, the drive wheel-transmission ratio is 1:2.77. So, multiply the number of drive wheel rotation by 2.77 to obtain the hand crank rotation number.

Calibration procedure (applicator with electronic scale)

1. Note the initial scale number.
2. Apply fertilizer an hectare in the field.
3. Subtract the number on the scale of the number you have noted.
 (this data is the application rate at which the transmission is now adjusted)
4. Adjust the transmission if needed and repeat steps 1 to 3.

INDUSTRIE AULARI inc.
 620 rang St-Roch St-Barnabé-Sud
 QC, Canada J0H 1G0
 Tél.: 1-877-892-2126

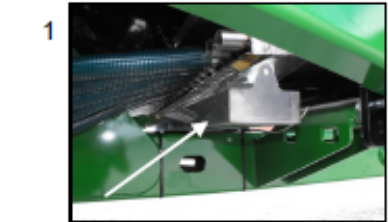

PF-PCAL-60P18M-RC
MAI2014

CALIBRATION PROCEDURE

Working width 60ft (with contact wheel)

Working width : 60 ft
 Contact drive wheel (circumference) : 50.27 in (4.19 ft)
 1 acre : 43 560 ft²

Calibration procedure (applicator without electronic scale)

1. Open the gate and install the calibration pan under the metering system.
2. Turn the contact drive wheel constantly for 10 rotations.
Or use the hand crank and turn for 28 rotations.
3. Weight the amount of fertilizer collected in the pan (in lb).
4. Multiply by the calibration factor 17.327 to obtain the application rate in lb/acre.
5. Adjust the transmission and if necessary repeating steps 2 to 4.

IMPORTANT : Be specific when you collect and weight the fertilizer, to ensure an accurate calibration .

Procedures	Data
We select an arbitrary value of rotation of the contact drive wheel (in this case 10 rotations).	1 rotation of the drive wheel = 4.19ft 10 rotations of the drive wheel = 41.90ft
Multiply the distance simulated by the working width to obtain an equivalence of 10 rotations of the contact drive wheel.	$41.90ft \times 60ft = 2514ft^2$
Divide an acre by the simulated surface to obtain the calibration factor.	$43\ 560ft^2 / 2514ft^2 = 17.327$
Multiply the amount of fertilizer in the pan by the calibration factor to obtain the application rate per acre.	$8.5\ lb^{**} \times 17.327 = 147\ lb/acre$

**The more you do rotation of the drive wheel and the greater you collect fertilizer in the pan, more accurate will be your calibration rate.

** For the hand crank, the drive wheel-transmission ratio is 1:2.77. So, multiply the number of drive wheel rotation by 2.77 to obtain the hand crank rotation number.

Calibration procedure (applicator with electronic scale)

1. Note the initial scale number.
2. Apply fertilizer an acre in the field.
3. Subtract the number on the scale of the number you have noted.
 (this data is the application rate at which the transmission is now adjusted)
4. Adjust the transmission if needed and repeat steps 1 to 3.

INDUSTRIE AULARI inc.
 620 rang St-Roch St-Barnabé-Sud
 QC, Canada J0H 1G0
 Tél.: 1-877-892-2126

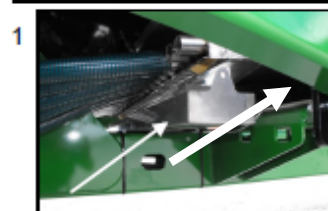

PF-PCAL-60P18M-RC
 MAI2014

MAINTENANCE



Always follow the safety instruction and the maintenance rule of the applicator

The applicator has been thru quality control at the factory. Then your dealer tested the equipment so the applicator is free of any defect or malfunction.

However to guaranty a use of the applicator without downtime and premature wear, you must follows the maintenance rules and cleaning procedure of this manual. Theses instruction must be done at the right time.

Cleaning

The cleaning of the hopper must be done to maximise the product life cycle. Even if the hopper is in stainless steel, we recommend cleaning it.

Pressure wash the whole unit once your work is done or after each period of use. Make sure that there isn't any fertiliser left on the applicator (either in the hopper or the frame).

To help you clean the distribution outlets, open the front stainless steel panel. It will be easier to clean the inside of the distributor. Be careful to not move the plastic caps inside the distribution outlet. [Figure 22A].

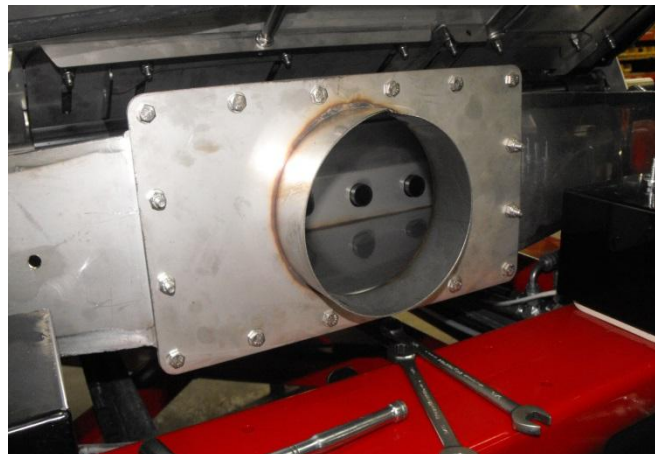

Figure 22A

Keep the channels of the metering shaft clean at all time [figure 22B]. The accumulation of fertiliser on the channel will reduce the fertiliser rate. Use the special scraper made by Aulari's. This scraper is located in the toolbox of the applicator.



Figure 22B

Beginning of the season maintenance

You must do a complete inspection of the applicator before using it. Clean all the dirt and grease on all the mechanical parts (sprockets, chains...). That way you make sure to prevent wear caused by dirt into the mechanical parts.

Storage and end of season maintenance

When you want to store the applicator: pressures wash it and make sure that there isn't any debris or dirt left. The dirt left on the applicator will keep the humidity and will cause rust.

Lubricate all the points showed in LUBRIFICATION section. Make sure that all the cylinder rods are protected from the corrosion and apply anti-rusting oil on the applicator.

Make sure that any part is missing or the any part is damaged. To order parts, please contact your dealer.

Lubricants and volumes

- ☞ Use EP2 universal grease to lubricate the applicator.
- ☞ The blower gearbox [figure 23, **A**] use gearbox oil A.P.I. GL5 (SAE 80W90) or synthetic oil (SAE 75W90). Volume: 1 liter.
- ☞ The variable transmission [Figure 25] which drives the metering shaft use Trans-Hydraulic fluid (automatic transmission fluid). Volume: 1.75 liters.
- ☞ The gearboxes located at the back [Figure 26] use NLGI 00 EP grease. Quantity: 0.35 kg

Lubrication of the blower's gearbox

Change the oil of the blower's gearbox [figure 23] at the beginning of the season. The temperature changes during the seasons create condensation inside the gearbox. When the water is in contact with the oil, it reduces the efficiency of the oil.

To do an oil change, remove the oil from the gearbox with a manual suction pump. Fill the gearbox with gearbox oil A.P.I. GL5 (SAE 80W90) or synthetic oil (SAE 75W90) until the oil comes out of the oil level plug [figure 23, **A**]. Verify the oil level every 50 hours and fill it up if needed.

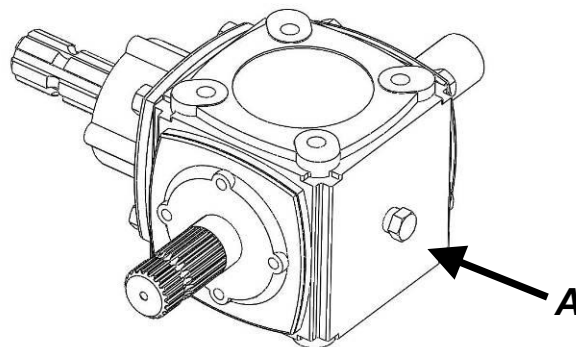

Figure 23

Belts tensions

To verify the belts tensions, open the safety guard. Make sure that the belts aren't crack or cutted. To adjust the belts tensioner [figure 24, **A**] tighten the tensioning screw [figure 24, **B**], in a way that the spring [figure 24, **C**] be stretched at 5" / 13 cm long [figure 24A]. Make sure that the pulleys are aligned.

- ☞ Too much pressure on the belt could result to premature wear on the belt, bearings and pulleys.

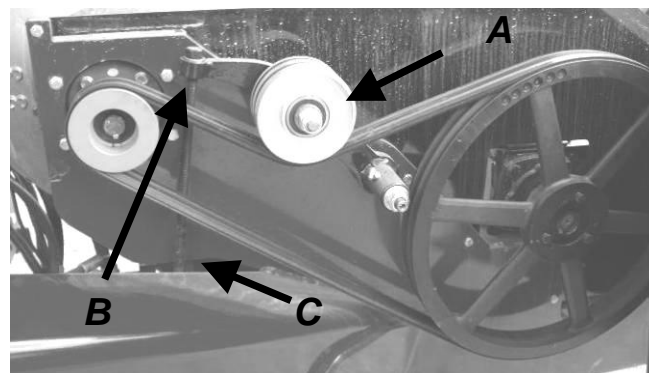

Figure 24



Figure 24A



Pay attention to the blower bearings. They are very important to the mechanicals components of the blower.

Attention: Too much grease in a bearing can pop the seal of the bearing.

Variable transmission fluid

Change the variable transmission fluid at the beginning of the season. The temperature changes during the seasons create condensation inside the gearbox. When the water is in contact with the oil, it reduces the efficiency of the oil.

To do an oil change: remove the drain plug [figure 25, **A**] at the bottom of the casing. To ease the drainage, remove the fill plug. [Figure 25, **B**]. Install the drain plug back then fill the casing with automatic transmission fluid (1.75 liters). Check into the clear window on the side of the gearbox, to verify the oil level everyday. This level is design for the oil at cold temperature. Fill it up if needed.

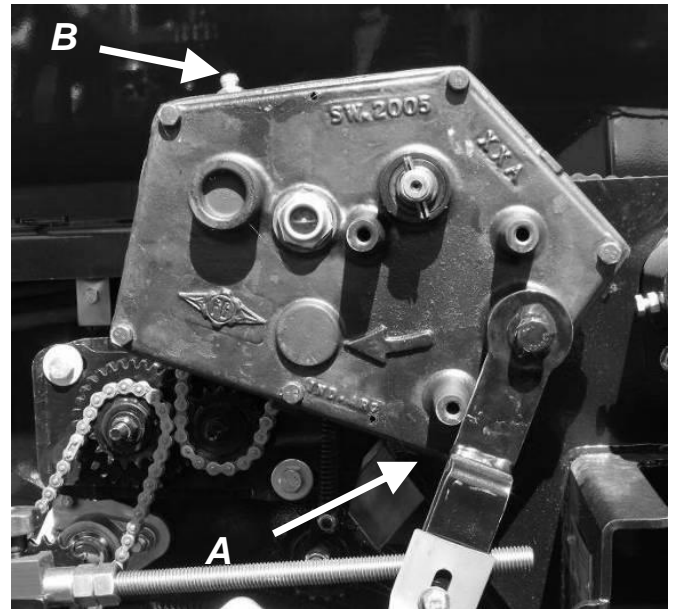

Figure 25

Repairing or removing the metering shaft

To be able to remove the metering shaft you need to:

1. Remove the chain
2. Untighten the bolts that hold the bearings housing on each side of the hopper. [1 bolt on each side, figure 27, **A**].
3. Move the metering shaft forward
4. Pull the shaft out by the opening

Attention: When you will reinstall the metering shaft, make sure that the shaft is at 6mm / ¼” of the bottom of the hopper. When you bolt it, put a shim underneath the shaft (on top of a channel) and verify the opening equal everywhere on the metering shaft. [Figure 25a, **A**].

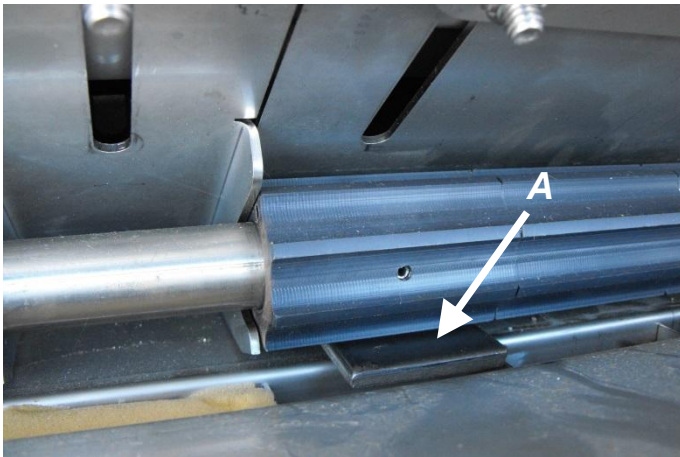

Figure 25a

- ☞ If that distance isn't equal all along the shaft, the rate won't be equal in all the outlets and the rate might be lower than what you expected.
- ☞ Verify everyday the bearings housing. They are very important for the efficiency of the metering mechanism. The shaft must always rotate easily if the chain installed.

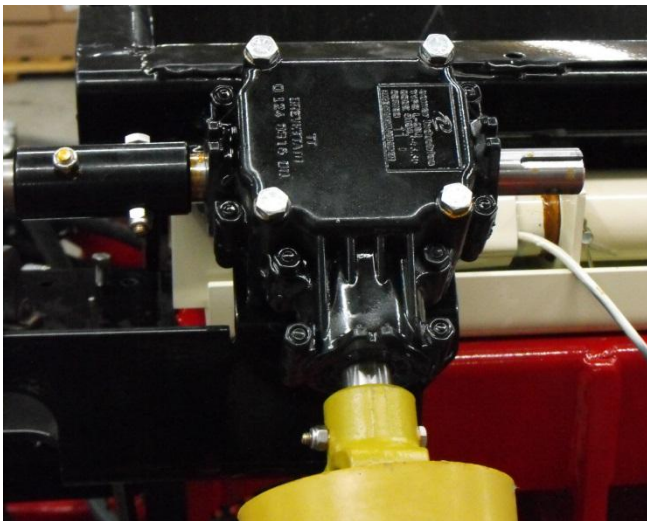

Figure 26

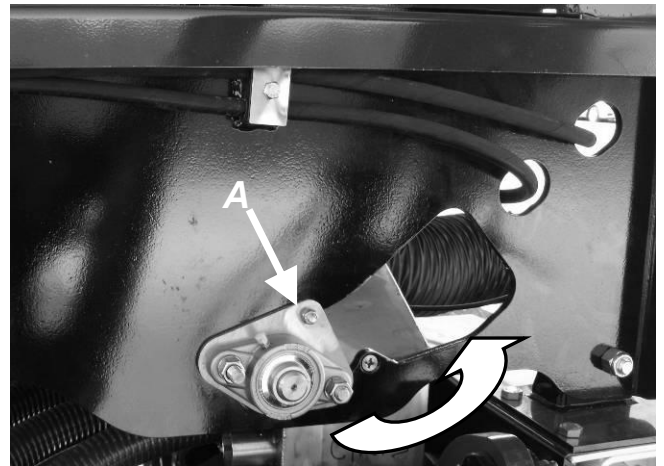

Figure 27

Wheel's hub

Once a year, verify the wheel's hub. Add grease if needed.

- ☞ **Attention:** Too much grease in the hub can cause damage to the seal.

It is recommended to disassemble the wheel's hub every 3 years or 2000 ha / 5000 acres. That way you can do a visual inspection of the internal components. Replace all the damaged parts.

1. Park the applicator on flat and solid surface.
2. Remove the tires on side of the applicator to have access to the wheel's hub.

- ☞ **Important:** Do not remove tires on both sides at the same time. Remove one side at once.

3. Remove the bolts of the hub's anti-dust cap.
4. Remove the pin, the castle nut and the washer.
5. Remove the outer bearing.
6. Remove the full bearing. The inner bearing and the seal will stay inside the hub.
7. Clean all the internal components and do a visual inspection. Change all the damaged parts.

☞ If you change a bearing, we suggest changing the bearing cup too.

8. Lubricate and install the inner bearing.
9. Install a new seal.
10. Install with care the hub on the axle.
11. Lubricate the inside of the hub and the outer bearing.
12. Install the outer bearing, the washer and the castle nut.
13. Tighten the castle nut.

14. Unscrew half a turn the castle nut and tighten it again to be sure that the bearings are sitting in the bearing's cup.

☞ Do not tighten the castle nut with a pneumatic tool.

15. Install the pin.

16. Install the anti-dust cap with the bolts.

LUBRICATING TABLE (GREASE)

Zone # Ref: [figure 27]	Lubricating Zones	Number of grease fittings	Interval
1	Blower's drive	7	Twice a year
2	Distribution's drive	7	100 hours

☞ Use EP2 universal grease.

Attention: Too much grease in the hubs and bearing can cause damage to seals.

• **ZONE 1**



PTO (Tractor end)



PTO (Applicator end)



PTO bearing support



PTO to Gearbox



Belt tensioner



turbine HE external bearing

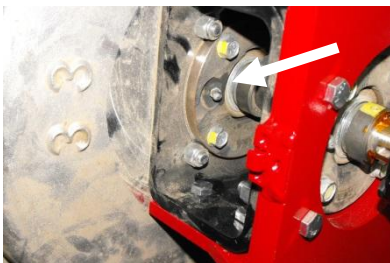

turbine HE external bearing

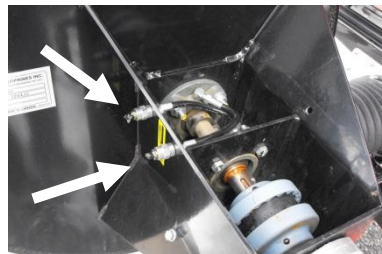

turbine BC172 bearing (option)

• **Zone 2**



Left side bearing metering shaft



Right side bearing metering shaft

LUBRICATING TABLE (OIL)

Points of lubrication	Lubricant type	Quantity	Intervals
Blower's gearbox [figure 23]	Gearbox oil A.P.I. GL5 (SAE 80W90) or synthetic oil (SAE 75W90)	1 litre	Once per season Verify every 50 hours
Variable transmission (metering system) [figure 25]	Automatic transmission fluid	1.75 liter	Once per season Verify everyday
2 rear gearbox [figure 26]	NLGI 00 EP grease	0.35 kg each.	Once per season, change if needed.

OTHER MAINTENANCE

Points of maintenance	Intervals
Verify mechanicals components of the drive: PTO shafts, belts, bearings, etc.	Everyday
Wheels hubs nuts: Recommended torque : 475 Ft-lb or 650Nm Recommended pressure**** <ul style="list-style-type: none"> ☞ Verify the tires everyday. Make the repair when needed. Refer to a tire specialist to make the repairs. ☞ Pay attention to the tires pressure. Consult the "MAINTENANCE" section to know the right pressure. Too much pressure in the tire can create a blowout and cause death. ☞ Never do a repair on a damaged rim. Always use OEM parts. Refer to the builder. 	After the 10 first hours of use than every 50 hours.
Drain the water left in the blower	Before the beginning of the season

**** For your information only. The recommended pressure may vary from one supplier to another. Always refer to manufacturer table.

Always lower the equipment attach to the applicator before repairing it.

BOLTS TORQUE CHART

SAE GRADES

Bolts Dimensions	Grade 2		Grade 5		Grade 8	
	Nm	Ft-Lb	Nm	Ft-Lb	Nm	Ft-Lb
5/16 - 18	15	11	24	17	33	25
3/8 - 16	27	20	42	31	59	44
7/16 - 14	43	32	67	49	95	70
1/2 - 13	66	49	105	76	145	105
9/16 - 12	95	70	150	110	210	155
5/8 - 11	130	97	205	150	285	210
3/4 - 10	235	170	360	265	510	375
7/8 - 9	225	165	585	430	820	605
1 - 8	340	250	875	645	1230	910

Bolts grades marking

Grade 2 = No marking

Grade 5 = 3 radial lines

Grade 8 = 6 radial lines

Metric

Bolts Dimensions	Grade 5.8		Grade 8.8		Grade 10.9	
	Nm	Ft-Lb	Nm	Ft-Lb	Nm	Ft-Lb
M5 x0,8	4	3	6	5	9	7
M6 X 1	7	5	11	8	15	11
M8 X 1,25	17	12	26	19	36	27
M10 X1.5	33	24	52	39	72	53
M12 X 1.75	58	42	91	67	125	93
M14 X 2	92	68	145	105	200	150
M16 X 2	145	105	225	165	315	230
M18 X 2,5	195	145	310	230	405	300
M20 X 2,5	580	205	440	325	610	450
M24 X 3	480	355	760	560	1050	780

Bolts grades marking

The value is mark on the bolt head.

Higher the value is, Higher the strength is.

Conversion chart

1 acre	=	0.405 hectare
1 hectare	=	2.471 acres
1 kg	=	2.204 lb
1 lb	=	0.4536 kg
1 inch	=	2.54 cm
1 foot	=	30.40 cm
1 foot	=	0.3040 meter
1 cm	=	0.3937 inch
1 meter	=	39.37 inches
1 meter	=	3.28 feet
1 km/hr	=	0.62 mph
1 mph	=	1.61 km/hr
1 inch sq	=	6.452 centimetres sq
1 cm sq	=	0.155 inch sq
1 foot sq	=	0.093 meter sq
1 mille sq	=	259.0 hectares
1 mille sq	=	2.590 kilometres sq
1 km sq	=	0.386 mille sq
1 gallon (Can)	=	1.201 gallon (USA)
1 gallon (Can)	=	4.546 Liters
1 gallon (USA)	=	3.78 Liters
1 Liter	=	0.2642 gallon (USA)
1 bushel (USA)	=	1.0321 bushel (Can)
1 bushel (Can)	=	274.92 liters
1 bushel (USA)	=	283.78 liters

