

MF 8S

205–265 HP

**A NEW ERA
FOR STRAIGHTFORWARD
AND DEPENDABLE
TRACTORS**



MASSEY FERGUSON





MF 8S - A NEW ERA

for Straightforward and Dependable tractors

“Much more than just a tractor, the MF 8S Series provides an enhanced operator’s experience. It encompasses the style of tomorrow and the uniqueness of Massey Ferguson”

Thierry Lhotte
Vice-President & Managing Director Massey Ferguson Europe & Middle East

The exciting new MF 8S Series heralds a completely new era for Massey Ferguson. It provides a complete farming solution designed to offer enhanced user experience encompassing the benefits of connectivity and smart farming technology.

To meet the demands of modern and sustainable farming Massey Ferguson combines state-of-the-art machinery with a whole new level of cab environment offering a comprehensive range of fully connected services to help you manage your business more efficiently. This personalised experience starts with the user considering the purchase and lasts through its entire dependable lifetime.

The MF 8S is a 100% connected tractor that enters in a new era of proactive and predictive support.

Its advanced connectivity ensures that drivers are always in contact with their farm, their fleet, their Massey Ferguson dealer and experts, so that you are never alone in the fields and operate in a sustainable and efficient manner at all times.

It also unlocks a whole range of innovative services tailored to your needs and, developed to keep your tractor running, operates at its best, maximising your fleet’s efficiency.

It is a tractor ahead of its time which outperforms on comfort, connectivity, ease of use, power efficiency, output, low cost of operation offering top reliability for fully maximised uptime and best return on investment.





MF 8S

DESIGNED BY FARMERS, FOR FARMERS

We began the MF 8S project with a blank page. At the heart of it was the global 'Voice of the Customer' study; an in-depth, one-to-one interview with customers and operators in several countries across the globe.

Key feedback from you, the customer, underlined the need for comfort, ease of use, value for money, excellent reliability, intuitive and convenient controls, efficiency transmitting maximum power to the ground, 100% connectivity and the ability to work with the most demanding implements.

It was an exciting and inspirational project for all those involved and an opportunity to build on Massey Ferguson's strong heritage of straightforward, dependable and accessible machines.

THE RESULT: A MASSEY FERGUSON TRACTOR FOR A NEW ERA. THE MF 8S.

MADE BY DESIGN
EXCLUSIVE MF PROTECT-U CONCEPT

06



MADE FOR SMART FARMING & CONNECTIVITY

20



MADE TO MAXIMISE UPTIME
A NEW ERA OF SERVICES & CUSTOMER SUPPORT

42



MADE FOR PERFORMANCE
ENGINE POWER EFFICIENCY

26



HIGH EFFICIENCY TRANSMISSIONS

28



LIVE FOR COMFORT
A NEW ERA OF CAB ENVIRONMENT

10



- Designed by Farmers, For Farmers..... 4
- Made by Design – Exclusive MF Protect-U Concept 6
- Your MF 8S at a Glance..... 8
- Live for Comfort – A new Era of Cab environment..... 10
- Made for Comfort – The Efficient Version..... 16
- Made for Comfort – The Exclusive Version 18
- Made for Smart Farming & Connectivity 20
- Made for Performance – Engine Power Efficiency..... 26
- High Efficiency Transmissions 28
- Made for Versatility & Traction..... 34
- Made For Hard Work – Hydraulics and PTO 38
- Made to Maximise Uptime – A new Era of services & Customer support..... 42
- Make the MF 8S as individual as your farm – Options & Specifications 48

MADE BY DESIGN

EXCLUSIVE MF PROTECT-U DESIGN - ENGINE & CAB INSTALLATION DESIGN PROVIDES VISIBILITY, COMFORT, EFFICIENCY AND ULTIMATE PERFORMANCE

The beauty of the MF Protect-U design, with a 24 cm gap between the engine and the cab, is what makes this tractor so disruptive and unique. Protecting and giving ultimate front visibility and comfort for the operator. Having the engine fully encapsulated and isolated from the cab reduces noise and vibration inside the cab becoming the quietest on the market at only 68 dB! It also contributes to heat insulation for the cab while improving engine cooling capacity and efficiency, maximising uptime. The cab, together with the wasp-waisted bonnet, the inclined windscreen bending toward the front, offers ultimate all round unequalled visibility, space and comfort.

THE PROTECT-U DESIGN

The encapsulated engine contributes to ultimate engine performance improving cooling capacities by always getting fresh air.

“The style of tomorrow. The uniqueness of Massey Ferguson.”

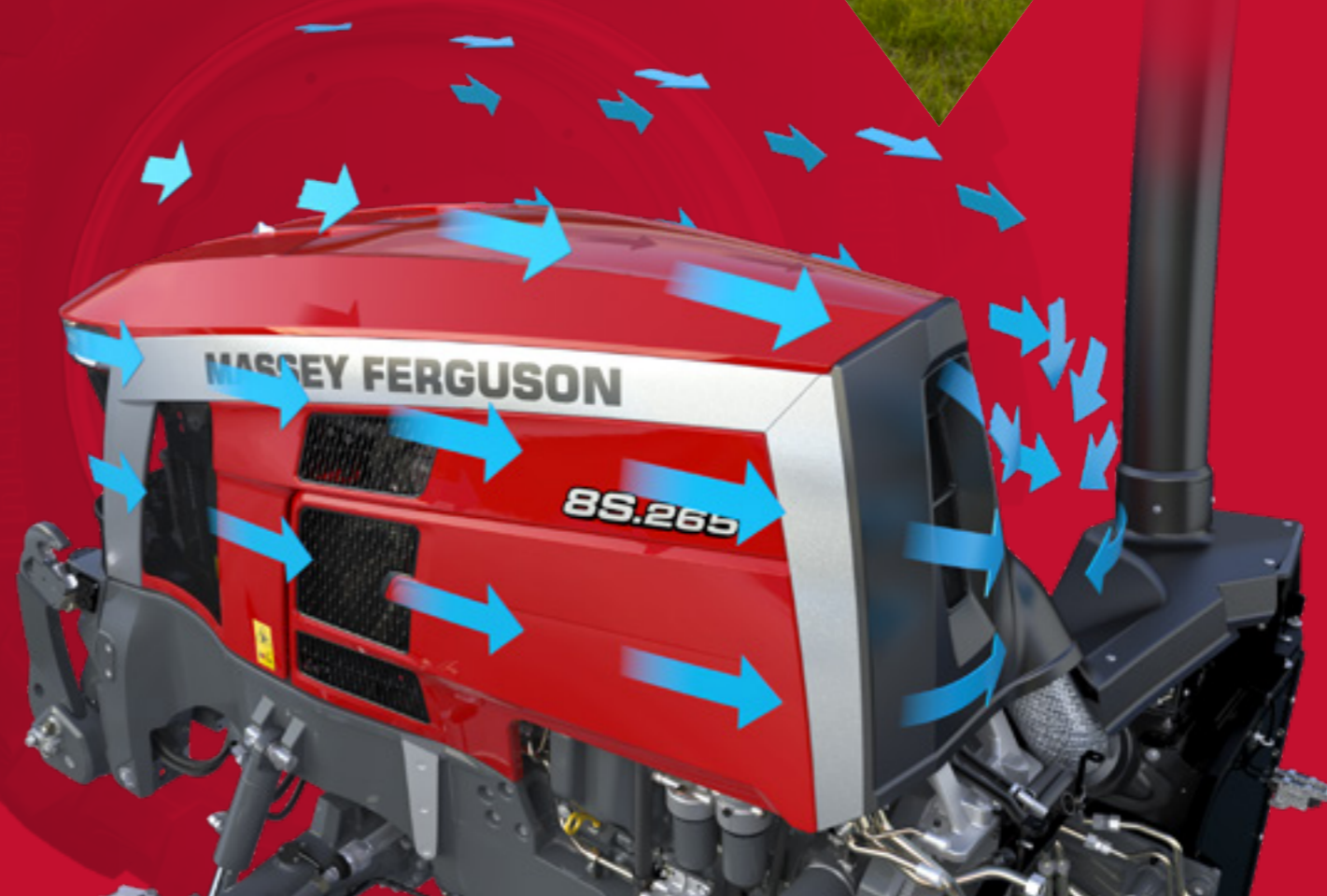

OUR PAST FUELS OUR FUTURE

The new MF 8S Series combines radical design with a practical purpose. The striking 'neo-retro' design pays tribute to the brand's legacy, illustrated by a new interpretation of the iconic MF grey sabre stripe on the side and horse head collar motif on the bonnet, which dates back to the MF 100 and MF 3000 series.



OUR PAST...



...FUELS OUR FUTURE

VIRTUAL REALITY



USE YOUR SMART PHONE TO STEP INSIDE THE MF 8S



STEP 1
Use a QR code reader app. Download it for free from iTunes or the Android Play store.



STEP 2
Open the app and scan this QR code...



STEP 3
...and step inside your Massey Ferguson tractor.

Live the eXperience in 2D, moving your smartphone around in all directions or using your fingers.



STEP 4
Live the full VR 3D Experience by clicking on the dedicated icon and use in combination with a pair of VR glasses.

Straightforward, smart, sustainable farming technologies. New Datatronic 5 and optional Fieldstar 5 terminal provide the latest user friendly precision farming package

- ▶ 9" touchscreen terminal created to provide a more intuitive and precise farming experience
- ▶ New MF Guide solutions provide economy by reducing overlaps
- ▶ MF Section and Rate Control allows you to adjust the application rate on the go, whilst automatically minimising overlap, skips and wasted product
- ▶ MF TaskDoc creates and sends securely detailed records of jobs to the office and preferred partners through the secured Agrirouter cloud
- ▶ MF Connect telemetry enables remote and near real time monitoring and decision making, improving efficiency and maximising uptime

Ability to work faster with the most demanding implements. Up to five spool valves to the rear and three to the front, including front linkage, and Power Beyond installation, plus a high lift capacity hitch. The hydraulic system offers the ability to work faster with the widest implements while increasing versatility.

Efficient drive-lines bring higher productivity and efficiency

- ▶ New Dyna-7 powershift transmissions offering incredibly smooth shifting raising comfort
- ▶ Dyna E-Power dual clutch transmission offering speed changes without torque interruption on the complete range of use
- ▶ Both transmissions come with Engine Power Management to deliver more power when it's needed most
- ▶ Perfect engine/transmission combinations provide maximum output and more power efficiency reducing power loss by up to 26%

The next level of space, comfort, ergonomics and connectivity

The quietest cab on the market with a noise level of only 68dB offering 360° visibility. Cab and front axle suspension improves driving comfort while the new MF vDisplay Digital dashboard provides all needed information at a glance. The new armrest offers best-in-class control of all the tractor's operations.

Low cost of operation

- ▶ Engine efficiency - max power and torque at low engine revs cuts fuel consumption by 10% and reduces noise level
 - ▶ Automatic valve clearance setting
 - ▶ Easy access to daily maintenance
- ▶ MFCare Repair and maintenance contract schemes

YOUR MF 8S AT A GLANCE

Your MF 8S is a tractor ahead of its time which outperforms on comfort, connectivity, ease of use, power efficiency, output, low cost of operation offering top reliability for fully maximised uptime and best return on investment.

WITH FOUR MODELS TO CHOOSE FROM, THIS IS ONE OF THE BEST CHOICES THAT YOU WILL MAKE.

	MF 8S.205	MF 8S.225	MF 8S.245	MF 8S.265
Engine	AGCO Power – Stage V – All-in-One technology			
Engine capacity	6 cylinder, 7.4 litre			
Transmission	New Dyna E-Power Dual Clutch or Dyna-7			
Max. power @ 1,850rpm	205hp	225hp	245hp	265hp
Max. power EPM	225hp	245hp	265hp	285hp
Maximum torque @ 1,000 - 1,500 rpm	950Nm	1,000Nm	1,100Nm	1,200Nm



LIVE FOR
COMFORT



THE CAB

THE NEW ERA of
Comfort, Visibility
and Controls

From the origins of modern tractor design, the Massey Ferguson cab has been renowned for excellence. With the MF Protect-U design, the MF 8S moves that legacy a step forward. It's something we work hard for, so you can sit and reap the benefits when days go on and on, in a very productive environment that blends space, comfort, visibility, quietness, ease of use, connectivity and quality. Because we know that a more productive operator is an operator who creates profit for his business.



3.4m³

Space for you and a passenger



VISIBILITY
6.6m²
GLASS SURFACE

and tilted windscreen providing safety, ease of operation and control on the job in hand



68dB

The quietest cab in the market today
reducing stress and fatigue

MADE FOR CONTRACTORS

“ We need our operators to be really alert and comfortable during the long working days. ”

A TRACTOR SHOULD NOT ONLY MAKE ITS DRIVERS COMFORTABLE **BUT ALSO PROUD.**

A driver who takes pride in his job is also more productive and creates profit. If you are a contractor or running a large farm with drivers, the MF 8S is a tractor which they will be proud to drive.

The immersive, connected and comfortable operator's environment consists of elegant, quality materials and finishes. The MF 8S cab has been carefully studied and designed with one objective in mind - enhanced driver functionality, for a truly unique farming experience.



MADE FOR COMFORT

SOMETIMES IT'S THE SMALL DETAILS THAT CAN MAKE A HUGE CHANGE TO YOUR WORKLOAD.

EASY AND SECURE ACCESS.

Large wide door, steps, rails and tiltable steering column provide best-in-class accessibility to the cab.

THE NEW MF VDISPLAY. The MF 8S's easy to read digital dashboard can be personalised.



ALWAYS CONNECTED - Two USB ports and adjustable phone and tablet holder available through AGCO Parts.

Bluetooth RDS/MP3 radio is fitted as standard allowing hands-free calls.

MADE FOR COMFORT

SUN SHADE. Up to four sun blinds, along with the tilted front windscreen and the large roof, provide shade for total protection.



FRONT WIPER. With the MF Protect-U cab design, 72% coverage of the windscreen is achieved. Lateral wiper option is also available.



SIDE MIRRORS feature an adjustable top and lower section offering the best view during transport and reduce blind spots. Options include: electric de-icing and electronically adjustable mirrors.



The **16 LED LIGHTS OPTION** transforms night into day. These include automatic beacon activation, comfort light delay at end of the day with automatic work lights extinction.



CAB SUSPENSION brings extra comfort. Two types available: mechanical and active mechanical.



The **ACTIVE MECHANICAL CAB SUSPENSION** uses silent block bushes and spring-assisted shock absorbers providing optimum damping forces for all driving situations. It is adjustable, allowing you to set the firmness of ride.

ALWAYS FRESH

EFFICIENT AUTOMATIC AIR-CONDITIONING is available and supplied through 14 automotive-style outlets located all around the operator for perfect air distribution...

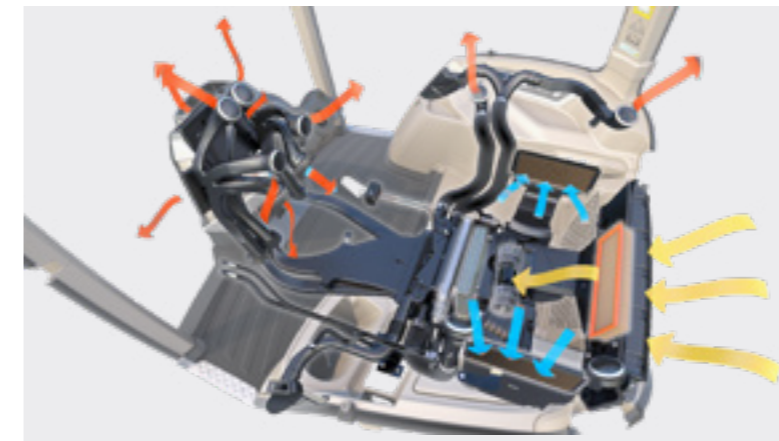

...and automatic management is available via the Datatronic 5 on the Exclusive version (optional on Efficient version)...



...and controls are easily accessible on the armrest.



Always get fresh drinks and food courtesy of the **COOL BOX** located under the passenger seat.



NOW PLEASE TAKE YOUR SEAT AND ENJOY COMFORTABLY YOUR WORKING DAY

Massey Ferguson offers the best-in class seat depending on models and options providing outstanding comfort.



BASE MODEL

Air suspended swivel seat



EFFICIENT VERSION

Automatic air suspended swivel seat, heated, lateral damping



EXCLUSIVE VERSION

Semi leather automatic air suspended swivel seat, ventilated, 2 levels of heating, lateral damping and dual motion backrest, with Dynamic Damping System

MADE FOR COMFORT

Efficient is the medium specification package for the MF 8S Series, designed to help you work smarter and get better results.

Dedicated to delivering increased productivity thanks to its key features, the Efficient package enables you to work faster, to a higher standard, with more accuracy, together with high levels of comfort, ergonomics and reliability. Stay in control of the most technologically advanced and demanding implements to take advantage of their increased productivity.

EFFICIENT VERSION

ADVANCED EQUIPMENT TO HEIGHTEN YOUR EFFICIENCY AT WORK

COMFORT & SAFETY

- STANDARD**
- QuadLink front axle suspension
 - Mechanical cab suspension
 - Air Conditioning with manual adjustment
 - Automatic air suspended swivel seat, heated, lateral damping
 - Radio Bluetooth/USB connector with integrated microphone - Controls in armrest

OPTION

- Mechanical active cab suspension
- Automatic Air Conditioning
- 16 LED working Lights
- Rear Camera
- Mirrors with electric de-icing and adjustment
- Semi leather automatic air suspended swivel seat, ventilated, 2 levels of heating, lateral damping and dual motion backrest, with Dynamic Damping System
- Radio Bluetooth /USB connector/DAB+ with integrated microphone - Controls in armrest

EFFICIENCY

- 40 km/h Dyna-7 or Dyna E-Power AutoDrive Transmission
- All controls in the ergonomic armrest with Multipad lever
- Closed Centre 150 l/min hydraulics
- Electrical and mechanical spool valves

- 50km/h Eco Dyna-7 or Dyna E-Power Transmission
- Closed Centre 205 l/min or 205l/min ECO hydraulics
- 4,800kg Cat 3 front linkage
- 1000rpm front PTO

CONNECTIVITY

- MF Connect telemetry with 5 years subscription
- Datatronic 5, 9" touchscreen with new interface all tractor function & technology
- Fieldstar 5 terminal
- ISOBUS
- MF Guide system with Advanced guidelines
- MF Section & Rate Control
- MF Task Doc Pro
- MF Next Management FMIS
- MF Task Doc recording all jobs' data



EFFICIENT ELECTRO HYDRAULIC MULTIFUNCTION JOYSTICK

- A Lift front linkage or rear valve control +
- B Lower front linkage or rear valve control -
- C Front or rear valve control +
- D Front or rear valve control -

Optional Datatronic 5 9" terminal

Multipad Lever

Driving Mode

Lights and Air Conditioning controls

Two mechanical spool valves



PTO Speed

Linkage controls

PTO engagement

Linkage Depth adjustment

Phone & Radio Control

Traction Control

Hand Throttle

MADE FOR COMFORT

Exclusive is a combination of high-spec versatility and refinement dedicated to operators looking for a tractor with advanced features and functions in terms of ergonomics, comfort, automation, Smart Farming capacities and full connectivity.

This version is aimed at more intensive, large scale operators looking for more advanced features that will ensure cost-effective benefits for their business. The Exclusive armrest comes with numerous benefits including comfort and convenience when operating multiple, frequently-used controls.

Exclusive also adds the Datatronic 5 as standard. Use the 9" touchscreen terminal to manage tractor functions, ISOBUS capability to simplify implement operations and use of MF Smart Farming solutions for Agriculture 4.0.

Using the Exclusive package, operate the most technologically advanced and demanding implements with the optimum efficiency to take advantage of their increased productivity.



EXCLUSIVE ELECTRO HYDRAULIC JOYSTICK

- A Lift front linkage or rear valve control +
- B Lower front linkage or rear valve control -
- C Front or rear valve control +
- D Front or rear valve control -



EXCLUSIVE VERSION

THE ULTIMATE EXPRESSION OF PRODUCTIVITY AND INNOVATION

COMFORT & SAFETY

- STANDARD**
- QuadLink front axle suspension
 - Mechanical active cab suspension
 - Automatic Air Conditioning
 - 16 LED working Lights
 - Rear Camera
 - Mirrors with electric de-icing and adjustment
 - Semi leather automatic air suspended swivel seat, ventilated, 2 levels of heating, lateral damping and dual motion backrest, with Dynamic Damping System
 - DAB Radio, Bluetooth, with integrated microphone

EFFICIENCY

- 40 km/h Dyna-7 or Dyna E-Power AutoDrive Transmission
- All controls in the ergonomic armrest with Multipad lever
- Closed Centre 150 l/min hydraulics
- 4 electrical spool valves with electrical joystick and fingertips

CONNECTIVITY

- Datatronic 5 9" touchscreen with new interface all tractor function & technology
- MF Guide guidance ready from factory
- MF Connect telemetry with 5 years subscription
- MF Task Doc recording all jobs' data
- ISOBUS

OPTION

- 50km/h Eco Dyna-7 or Dyna E-Power Transmission
- Closed Centre 205 l/min or 205l/min ECO hydraulics
- 4,800 kg Cat 3 front linkage
- 1,000 rpm front PTO
- Up to 8 electrical spool valves fully configurable and customizable on the Exclusive armrest

- MF Guide system with Advanced guidelines
- MF Section & Rate Control
- MF Task Doc Pro
- MF Next Management FMIS
- Fieldstar 5 terminal

Multipad Lever

Driving Mode

Datatronic 5 9" terminal

PTO engagement

3 fingertip spool valves

Lights and Air Conditioning controls

Linkage Depth adjustment

Phone & Radio Control

Traction Control

Hand Throttle

MADE FOR SMART FARMING & CONNECTIVITY

The New MF 8S range has taken Smart Farming and connectivity to new heights.

It features the MF 8S with the latest standard Connective Package, which comes with Real Time Information and Remote Service. What's more, it comes with a new and more intuitive Datatronic 5 interface as well as with the Fieldstar 5 terminal to control Smart Farming and Agriculture 4.0 features such as: MF Guide, MF Section and Rate Control as well as data transfer and management through MF Task Doc and Task Doc Pro.

“We run our operations with the very latest technology and need to reduce inputs as well as using excellent data management facilities.”



DATATRONIC 5

Powered by Fuse® Smart Farming Solutions



Full tractor functions management and optimisation features such as transmission, engine and hydraulics. Moreover there is the remarkable Dual Control system providing excellent control of semi-mounted ploughs by automating the furrow entry and exit. At the same time the system adjusts the plough's depth wheel in relation to the rear linkage.



Video Mode – Pictures from the on-board camera can be displayed on the console screen, allowing operators to monitor complex implements or simply improve safety and efficiency when reversing.



Headland management settings – The Datatronic 5 comes as standard with the most intuitive, straightforward and easy to use automatic headland management system available in the market. It is designed to save you significant time at headlands, allowing you to concentrate on the operation in hand so that you can maximise outputs with ease.



ISOBUS for total implement control – ISOBUS allows an implement manufacturer's control system to be displayed on the terminal screen, saving owners and operators time and money, with no need to install additional monitors in the cab. Simply plug the implement lead into the tractor's ISOBUS socket and the system automatically uploads the operating menus and displays on the screen. MF 8S ISOBUS applies to the AEF certification.



ISOBUS MultiPad switch assignment - ISOBUS implements can be controlled directly using the MultiPad lever. Having all controls (tractor and implement) on the same lever is a lot more convenient than using additional displays and levers.



Memorise data and settings – Unlimited number of user settings configurations enable the system to record information during operation on area worked, fuel use, hours worked and much more. All the settings and parameters can be stored by the Datatronic terminal. All these settings can be stored and recalled to find the previous setting that was used on a tractor.



MADE TO KEEP YOU ON TRACK

MF Guide is Massey Ferguson's full featured, hands-free steering system. MF Guide is capable of delivering sub-metre, decimetre and centimetre accuracy, increasing the efficiency of your farming operations.



CHOICE OF RECEIVERS & CORRECTION SIGNALS



xFILL™ TECHNOLOGY
Should you lose your signal due to the terrain, MF Guide continues to work reliably up to 20 minutes without a correction signal thanks to Trimble®-xFill™ technology.

RTK Corrections



NovAtel®



Trimble®

With the new Massey Ferguson MF Guide, there are now two different receiver systems available: NovAtel® and Trimble®. Existing Trimble® RTK infrastructures on the farm, such as NTRIP, can continue to be used. Talk to your local Massey Ferguson Dealer or Distributor to find out more.

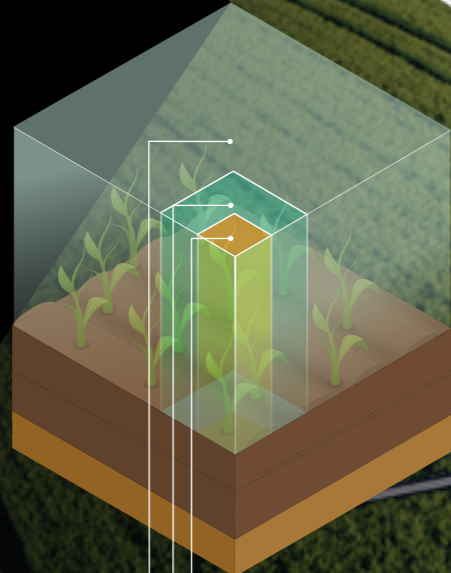

- 2cm: Novatel/Trimble RTK
- 4-15cm: Novatel/Trimble optional correction signals
- 15-30cm: Novatel/Trimble Standard

EASY, FAST SET-UP WITH GO MODE FUNCTION

Starts up within 5 minutes, even for first time users. This allows the operator to begin working with auto-guidance/steering for the first time in three easy steps...



... IMPLEMENT...

...WAYLINE...



KEY BENEFITS FOR YOU



12% FUEL SAVING

Guidance systems are proven to save up to 12% fuel in field operations.

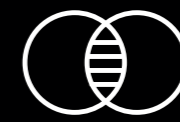

NO OVERLAPS

MF Guide virtually eliminates overlaps.



SAVINGS

Using MF Guide helps you save money by reducing overlaps, precision application and increasing efficiency.



COMFORT

Using MF Guide helps to reduce fatigue and stress by guiding you efficiently through your working day.



MFsection control

FUSE SYNCHRONISED

MF Section Control is the new Precision Farming solution from Massey Ferguson providing the most advanced and most efficient Section Control feature managing up to 36 sections and 5 applications. With the fully automatic Section Control for ISOBUS implements, operators can apply seeds, fertilizer or pesticides without overlapping. This prevents double treatment and areas worked outside of the field edges. With the aid of the straightforward and easy to use Section Control assistant, the operators can set the correction values for each implement, quickly and easily. The system uses the tractor's GPS system to automatically turn on and off individual sections in areas that have already been covered which automatically results in economical application and enhanced yields.



MFrate control

FUSE SYNCHRONISED

Variable application with Variable Rate Control (VRC)
Data transfer with TaskDoc™ Pro now permits variable rate application, based on the needs of the soil or plants, and therefore saves operating inputs. The individual requirements for seeds, fertiliser and pesticides are shown on application maps. They are then called up during operation and automatically executed. The big advantage: operating inputs can be defined and planned with the aid of the field database and then applied with utmost precision. For example, you can tailor chemical or fertiliser application in areas as required, lowering input cost and further enhancing yields.

MF TASK DOC & AGRIRouter: NEXT MACHINE MANAGEMENT

MFtask doc

FUSE SYNCHRONISED

Information is power, with accurate data measurement and recording enabling more precision in decision making. The new TaskDoc™ system has a place in the future of agriculture, helping farmers to become more productive through the knowledge brought by putting precision-measured data at the business owner's fingertips.

With **TaskDoc™** all jobs' data can be recorded with a minimum of effort, documented in the field record and then analysed, all in the shortest amount of time. The data is transferred via USB Stick from the Datatronic 5 terminal to the office using the ISOBUS standard TC-BAS. Data on the quantity of seeds and fertiliser applied or the fuel consumption is available immediately after the work is done.

The **TaskDoc™ Pro** version, also enables recording of the GPS position data and data transfer in real-time via mobile through the secured AgriRouter Cloud service. This makes automatic, seamless exchange with ISOXML-capable field management software and mapping possible including in MF Next Management FMIS. The data for the operating inputs that have been used are transferred and can also be monitored through the Datatronic 5 terminal while working.



AGRIRouter



This universal data exchange platform lets you connect machinery and your Farm Management Information System (FMIS), regardless of vendor or manufacturer. You can also determine who to exchange data with, and to what extent. AgriRouter is your ticket to the digitalization of agriculture, enabling you to retain control of your data.

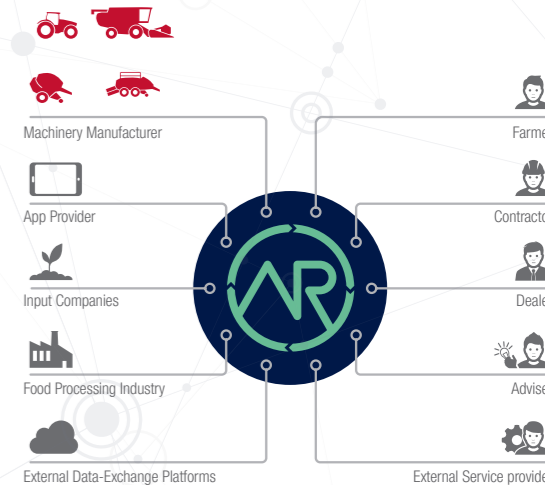

MADE FOR PERFORMANCE

THE PURE EXPRESSION OF POWER EFFICIENCY

The new MF 8S, teamed up with the most mature engine SCR technology on the market, the undisputed sustainable leader in heavy duty farming operations delivering class-leading power and torque, with best-in-class Total Cost of Ownership.

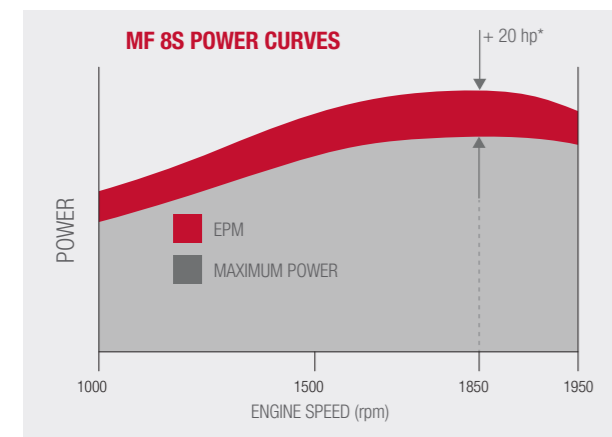
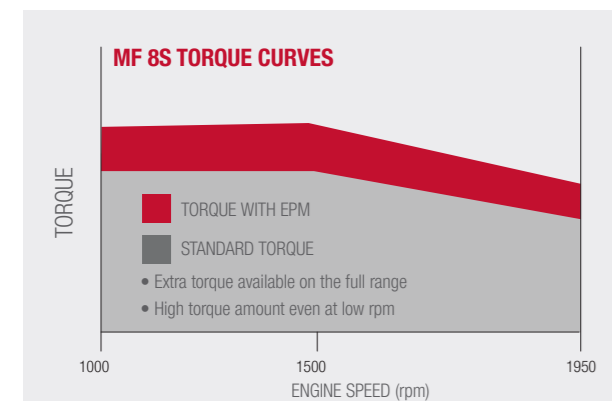

EPM available on the full range (not only at Max power)
Constant power between Max power rpm & Max torque rpm

EFFICIENT SUSTAINABILITY

7.4L, 6-cylinders AGCO Power engine maximises the advantages of the most environmentally-friendly de-pollution system to improve air quality, mitigate climate change and contribute to a quieter environment for the operator and the neighbourhood during working hours.

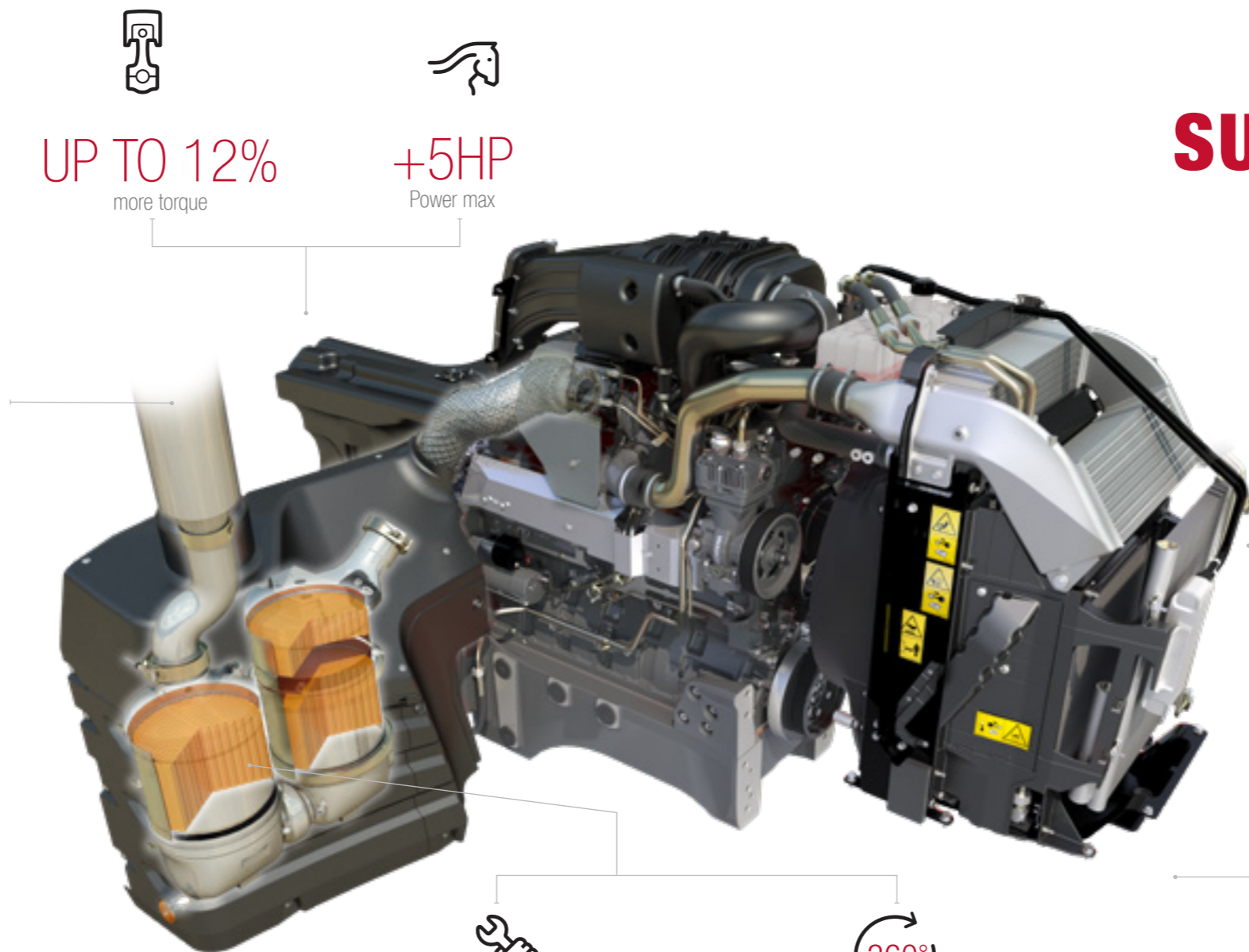

UP TO 12% more torque



+5HP Power max



-40% Particle reduction



+8% POWER with Engine Power Management



+5% Productivity



10% FUEL SAVING Fuel Savings by lower engine revs



-5.5dB by lower engine revs



LOW IDLE Automatic low idle system cuts engine revs to save fuel and reduce noise



LOW MAINTENANCE COSTS



NO COMPROMISE The All-in-One de-pollution system is packed up neatly under the cab contributing to keep visibility

EPM

EPM OFFERS UP TO 20HP MORE WHEN IT IS MOST NEEDED.

This means your MF 8S responds automatically to the load imposed on it, and adjusts fuelling accordingly to give you extra power. Designed to tackle tough transport and PTO work challenges, advanced electronic engine and transmission management makes more power automatically available under load or at speed.

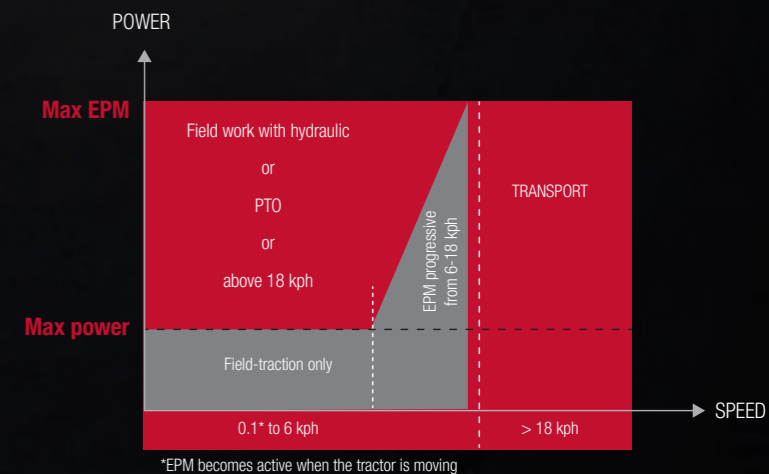

HIGH EFFICIENCY TRANSMISSIONS

WHEN IT COMES TO DRIVE POWER, WE'VE REALLY SHIFTED UP A GEAR AT THE SPEED OF MIND

The MF 8S is available with the choice of two fully new and automated transmissions offering the most advanced technology in its category, best-in-class ease of use, smooth shifting, efficiency delivering straight power to the ground. Speed shifting is fully automatic and as quick as the speed of mind.

DYNA-7 AND DYNA E-POWER ARE THE BEST CHOICE OF TRANSMISSIONS EVER.

Easy to use. Smart to operate. Efficient and comfortable.

MADE FOR CONTROL

“Control in the palm of your hand.”

The Multipad lever operates the transmission as well as controlling cruise control, the rear linkage, PTO, headland management, spool valves through the integrated micro-joystick. All operations are easily to hand for greater comfort.



POWER CONTROL LEVER

Exclusive, Simple, the unique Massey Ferguson Power Control lever provides straightforward three-in-one operation.



- YOU CAN:**
- shuttle between forward / reverse
 - shift speeds and ranges: up and down
 - de-clutch
 - select neutral

LEAVING YOUR RIGHT HAND FREE TO OPERATE A LOADER OR ANY IMPLEMENT HYDRAULICS.

DYNA E-POWER

A New Era of Dual Clutch transmission technology.

EFFICIENT POWER. NO TORQUE INTERRUPTION.



At the heart of the 4-range, 7-powershift Dyna E-Power transmission is the **Dual-Clutch**, similar to the technology you are used to in your fully automatic car.

Dyna E-Power is the **new Dual-Clutch transmission** designed by Massey Ferguson for the MF 8S range. With Dyna E-Power we have developed a system of **power transfer to the ground** that surpasses all others for **ease of use** and **precision** offering the **comfort** of a CVT with the efficiency of a semi-powershift transmission.

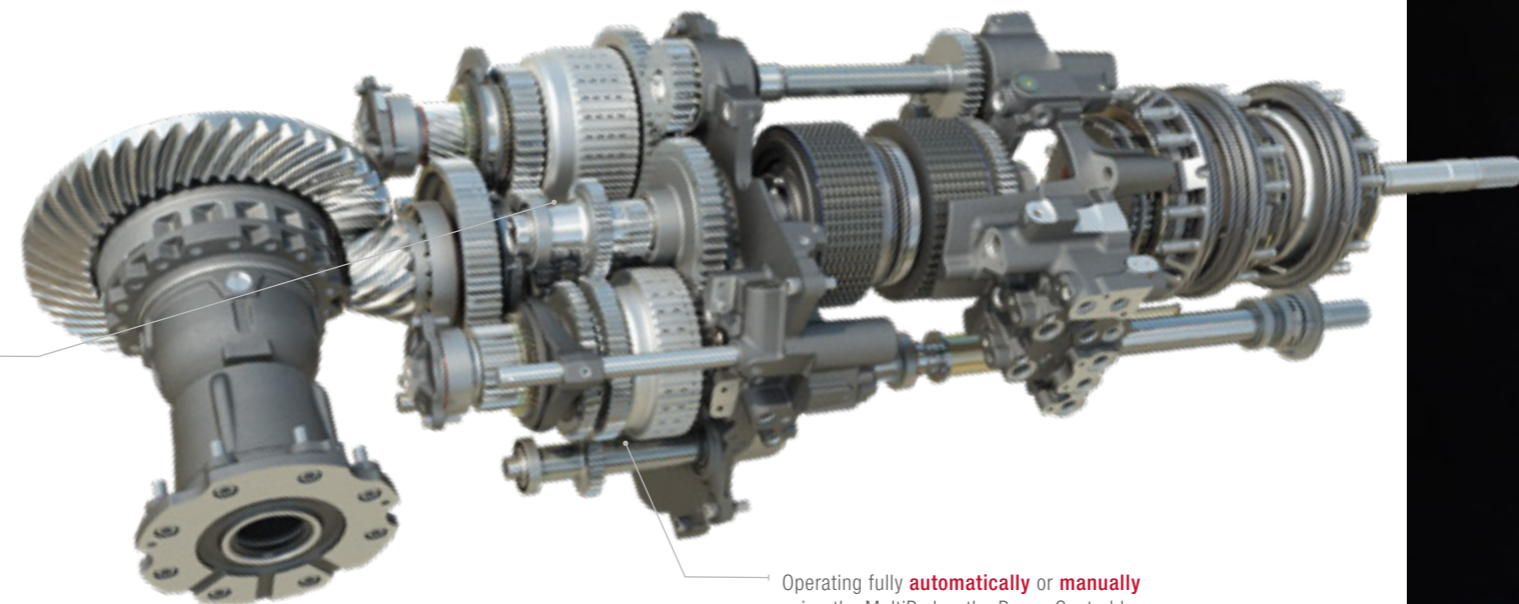

Operating fully **automatically** or **manually** using the MultiPad or the Power Control lever, it is also possible to adjust how aggressively and quickly fully automatic changes are made to match work and conditions.

DYNA E-POWER TRANSMISSION

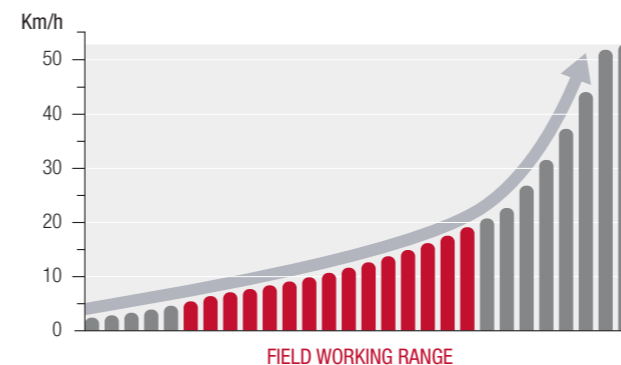

◀ **SMOOTH TRANSITION THROUGH ALL THE GEARS:** Flat shape on the first half of the curve for more precision in the field. Steeper curve on the second half to achieve top speed faster.

DYNA E-POWER BENEFITS AT A GLANCE

- ▶ Highly efficient Dual-Clutch technology like in a wide range of automatic cars
- ▶ Transmits power from the engine to the ground – efficiently and productively
- ▶ Prevent loss of power with no torque interruption on the full range of use
- ▶ Instantaneous gear/range change means uninterrupted power transfer to the ground
- ▶ Delivers CVT-like operation increasing operator's comfort and overall efficiency
- ▶ Gears change seamlessly, smoothly and efficiently, with only a 9% difference between each speed in field work applications from 5km/h to 20km/h
- ▶ 15 speeds in the field working range



28x28
Speeds



-26%
power loss



5%
Fuel savings

DYNA-7 TRANSMISSION

Made for power efficiency.
Transmission technology.

DYNAMIC PERFORMANCE COMES AS STANDARD



The new Massey Ferguson's Dyna-7 semi-powershift transmission is building on the strong legacy from the Dyna-6 renowned for its **performance** and **efficiency**. It is now even more refined. This provides not only one extra powershift speed and smoother shifting, but it is also **15% more efficient than the Dyna-6**.

Dyna-7 comes with Eco as standard - reducing engine speed at maximum forward speeds providing a **quieter drive** and **less fuel consumption**.

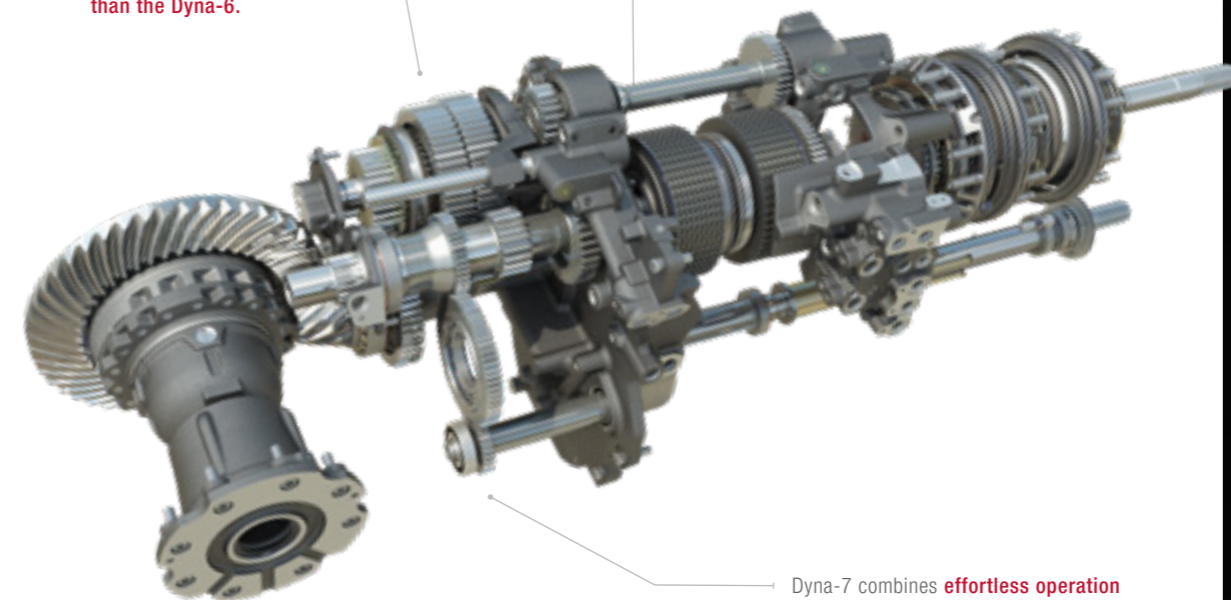

Dyna-7 combines **effortless operation** with complete efficiency to create an **extraordinary operator's experience**. Dyna-7, uniquely, provides a smooth, 7-speed Dynashift change in each of 4-ranges, giving a tremendous range of powershift flexibility over a wide speed range, giving maximum field performance. Both Dynashift and range changes are made under load, without the need to use the clutch pedal.

DYNA-7 TRANSMISSION

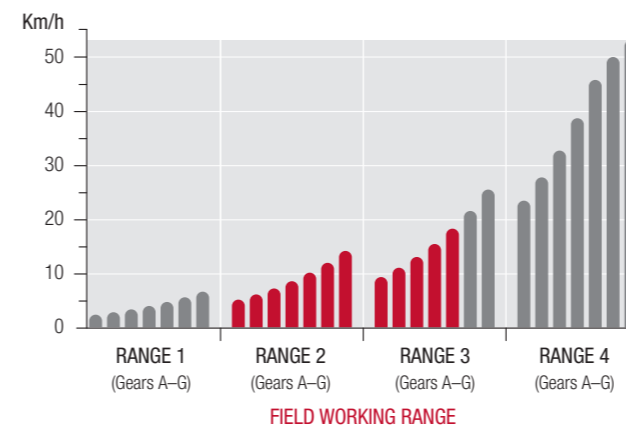

DYNA-7 BENEFITS AT A GLANCE

- ▶ 12 speeds in the Field Working Range
- ▶ 40 Km/h or 50 Km/h maximum speed available* at low engine speed (Eco)
- ▶ Eco feature allows top speeds to be achieved at low engine revs (Maximum 53 km/h @ 1,650 rpm), offering a reduction in noise and fuel consumption
- ▶ Cruise control speeds (C1/C2)
- ▶ Brake pedal puts transmission in neutral
- ▶ Reverse shuttle aggressiveness adjustment, separate adjustment for forward and reverse
- ▶ Aggressiveness adjustment for Dynashift ratios

* Depending on market legislation



28x28
Speeds



-15%
power loss
Vs Dyna-6



5%
Fuel savings

MADE FOR VERSATILITY & TRACTION

Tractor power means nothing if it cannot be transferred to where it matters: the ground

With a minimum weight of just 8.7 t, the MF 8S Series tractors are lighter than others in this class. This allows them to tread lightly for top work and transport, while the strong design also enables them to carry heavy loads or be ballasted up for draft operations.

A wide range of ballast and tyre choices, including a large rear wheel diameter of 2.05m, ensures that MF 8S tractors can be tailored precisely to the tasks that are expected of them, for maximum traction with the maximum soil preservation, whilst using the minimum of fuel.

That is part of our commitment to help protect the soil and preserve the land for future generations.



“Our land is heavy clay so minimising soil compaction is extremely important.”



▲ BALLASTING FOR FLEXIBILITY

To deal with intensive traction work or counter ballast (front or rear), sometimes you need extra weight, so a wide choice of ballasts is available. The MF 8S is available from factory with additional front and rear weights to exactly match your needs.

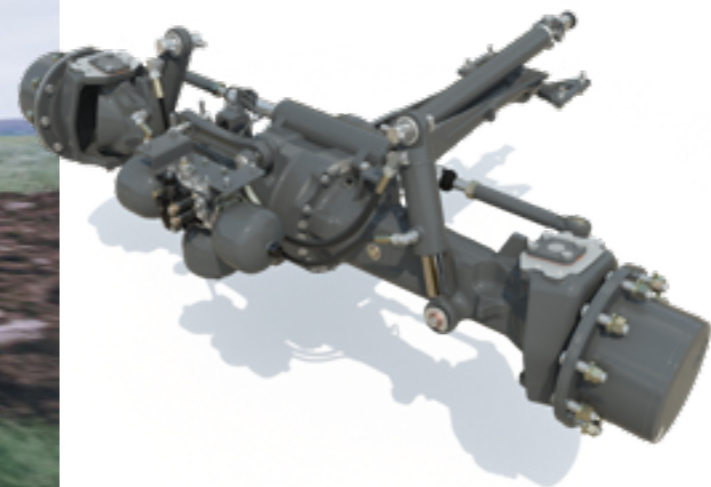

5.7m
turning radius*

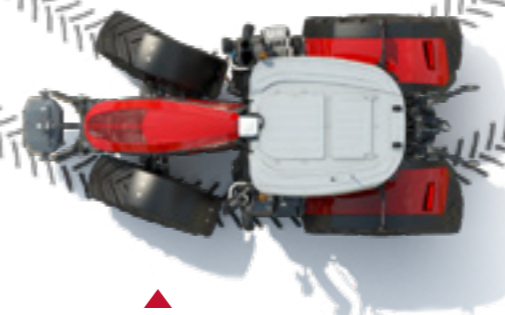

▲ MANOEUVRABILITY

Improved manoeuvrability for loader operation, in the farm yard and when turning at the headland.

The curved design of the chassis and bonnet ensures ONE OF THE BEST TURNING CIRCLES ON THE MARKET.

◀ QUADLINK FRONT AXLE SUSPENSION

Improved comfort and safety for transport applications and greater traction is delivered by a new and innovative front suspension option. The simple design produces superior ride comfort, turning angle and offers the full angle of oscillation as well as maximising ground clearance. Completely maintenance-free.

*Track 1950mm with 600/70R30 front tyres

PERFECT WHEELBASE FOR THE PERFECT POWER AND SOIL PRESERVATION.

Wheelbase length is 3.05m offering improved stability with or without a heavy implement, maintaining high levels of traction in the field and increased comfort in transport.

The combination of the wheelbase and the MF 8S chassis design means that less ballasting weight is needed, ensuring maximum soil preservation and reduced ground pressure during cultivation, drilling and seeding

▼ **SPEEDSTEER** reduces operator effort and provides faster turns - maximising your time in the cab.

It enables the operator to adjust the steering ratio and select the number of turns of the steering wheel required for a given amount of steering angle turns.





MAXIMUM TRACTION, SOIL PRESERVATION & LOW FUEL CONSUMPTION WITH **TRELLEBORG TYRES**

NO MACHINE WORKS IN ISOLATION ON A FARM

so working closely with tyre and farm equipment manufacturers makes sense and helps us all to develop our technology. The results of our joint partnerships enhance the quality, productivity and performance.

Matching the tractor with the best tyres for the job not only helps to protect the soil, but makes a big difference to your work.

Introduced as a concept on the MF NEXT Concept tractor at AGRITECHNICA 2019, the new Trelleborg TM1000 ProgressiveTraction tyres are now made a reality for the new MF 8S.



The new TM1000 ProgressiveTraction®, engineered according to the VF standards, is an innovative product which:

- ▶ provides superior flotation
- ▶ places less stress on the soil
- ▶ provides superior traction
- ▶ guarantees lower fuel consumption and emissions
- ▶ provides excellent handling and comfort
- ▶ has an extended lifetime

SELECTING THE CORRECT BALLASTS & TYRES: BENEFITS AT A GLANCE

- ▶ More power to the ground
- ▶ Ultimate traction capabilities
- ▶ Limited soil compaction to boost yields whilst maintaining soil health for the next generation
- ▶ Improved fuel economy



UP TO **+10%**
Improved traction



+13%
Footprint for lowest soil compaction



3%
Fuel savings



MADE FOR HARD WORK

OUTSTANDING OPERATION AND PERFORMANCE TO TACKLE ANY TASK AND UNLOCK ANY FIELD

Modern implements are placing more and more demands upon the tractors that power them, which are asked to perform faster and respond better. The MF 8S comes with immense capabilities to easily handle heavy-duty applications with outstanding lift and drive capacities for the very latest implements. The MF 8S is a tractor which is powerful, full of torque and nimble capabilities. Perfect if you are looking for a machine with unbeatable power take off, for outstanding operation and performance when working with the most advanced implements.



“The MF 8S is a tractor which is powerful, full of torque and nimble capabilities.”



MADE FOR HARD WORK

UP TO 205 l/min ECO

Hydraulic efficiency is key for the overall performance of the tractor. MF 8S comes as standard with 150 l/min Closed Centre Load Sensing hydraulics with the option of 205 l/min and 205 l/min ECO offering the highest flow at low engine revs to save fuel.



Up to **2** front spool valves and free return.



Up to **4,800 kg** lift capacity. Heavy duty Integrated Front Linkage System (IFLS) is available as an option and is designed to match the front suspension.



ISOBUS connector to connect to your implements.



1,000 RPM front PTO is available. Combined with the front linkage allows a wide range of additional implements to be powered: reducing passes and improving efficiency. Benefit from real time savings – more than doubling output when mowing grass.



4 PTO speeds as standard: 540, 540 ECO, 1000 or 1000 ECO. Offering more flexibility, whatever the task. Speeds are achieved at around 1550 engine rpm, further improving fuel economy and helping to reduce in-cab noise levels.



Up to **10,000 kg** lift capacity from heavy duty rear linkage with Ultimate Draft Control. MF's digital ELC system gives the highest standards of draft control with more accurate depth settings and better ground contour following. The result is more weight transfer, better traction, less wheelslip, reduced tyre wear and reduced fuel consumption whilst still maintaining greater output.

POWER BEYOND

BUILT INTO THE CCLS SPOOL BLOCK IS A POWER BEYOND FACILITY that via additional flow and return pipes provides oil flow directly from the pump, enabling additional remote spool valves to be connected.



Up to **5** rear spool valves and free return with decompression lever

MADE TO MAXIMISE UPTIME



ENHANCED TRACTOR OWNERSHIP EXPERIENCE & COMPLETE PEACE OF MIND



CONNECTED ANYWHERE. ANY TIME.

STANDARD WITH **5 YEARS**
SUBSCRIPTION.

GREATER UP-TIME, OPTIMISED MAINTENANCE AND
SMARTER SERVICES WITH MF CONNECT.

OWNER, DEALER AND TRACTOR ARE 100%
CONNECTED!

MF Connect is a fleet monitoring system, that allows customers to keep
a close eye on their Massey Ferguson machines.

Viewing machinery operations and equipment operating parameters in
virtually real time on their mobile phone, tablet or desktop computer
has never been easier.

This enables owners and managers to manage operations more
effectively, helping to improve operating efficiency with remote
diagnostics, ensuring optimum uptime.



**Fix your costs and guarantee optimum
performance for your MF 8S with MF Care.**

MF Care Service and extended warranty contracts are flexible
to suit your payment and operating hours requirements.
Regular servicing provides preventive maintenance – picking
up any faults before they become a problem, which helps
reduce downtime. A full dealer service history using genuine
AGCO Parts will also increase the residual value of the
machine.

- ▶ Support maximum residual value of your tractor
- ▶ Flexible terms and long-term price packages
- ▶ Available up to 12 months from registration
- ▶ Experienced MF technicians available for on or off-site servicing

	SILVER	GOLD
DETAILS	REGULAR MAINTENANCE CONTRACTS The Service Package includes all prescribed maintenance work on the basis of fixed prices.	REPAIR CONTRACTS Extended warranty contracts which offer security against repair costs (except wear). Tariffs with or without excess available as an option.
MACHINE TYPE	All	All
REGULAR MAINTENANCE*	YES	YES
REPAIR COST	NO	YES
DEDUCTIBLE	NO	Option: €0, €190, €490

*the list price stated by AGCO refers solely to the extended warranty and doesn't include maintenance.

MASSEY FERGUSON OFFERS A COMPREHENSIVE AND EFFICIENT RANGE OF SERVICES

6,000 hrs 5 years	3,000 hrs 5 years	50,000 bales 5 years	6,000 hrs 5 years	2,000 hrs 3 years <small>ISOBUS compatible machines only</small>	25,000 bales 3 years



YOUR COURTESY FLEET

'MF Always Running, Your Courtesy Fleet'* provides you with a temporary replacement tractor to ensure you can continue working with minimum interruption to maximise uptime while your tractor is being serviced or repaired.

We know that you can't stop until the job is done and MF Always Running ensures the need for maintenance or repairs won't stop your operations. As an MF tractor owner you will be quickly back up and running with a replacement tractor – but not just any tractor, it will be the latest model equipped to the specifications you need to get the job done.

* Please contact your local Massey Ferguson Dealer to check availability in your area. Terms and conditions apply that might vary according to the market or country. Available in the UK, Ireland, France, Germany, Italy, Spain, Poland, Norway and Denmark.

MASSEY FERGUSON 24/7 CUSTOMER HOTLINE

Your Massey Ferguson dealers are always by your side to make sure your Massey Ferguson Machine is Always Running.

In case you need any support on your machine simply call your certified service centre 24/7 on the emergency hotline. Service available in Denmark, France, Germany, Italy, Norway, Poland, Spain, UK and Ireland.



24/7 HOTLINE +800 8700 365 7



PARTS & SERVICE

IT'S ALL ABOUT A LIFETIME OF SUPPORT

Buying, owning and maintaining farm machinery can be complex, so having absolute peace of mind that you have great back-up and support is a hugely important consideration. As a Massey Ferguson customer you are assured of personalised, responsive and friendly support from our network of expert dealers who truly understand your business.

There's no cut-off time for Parts and Service because a machine may be out of service. We're available to you throughout your ownership of your Massey Ferguson machine.

We take great pride and responsibility in every machine we sell and we make it our mission to keep your machinery running reliably, every time you turn the key.

“ I want daily maintenance to be quick and easy so I can spend more time with my family. ”

THE MF 8S HAS BEEN DESIGNED TO PROVIDE FAST, STRAIGHTFORWARD, EASY AND COST-EFFECTIVE ROUTINE MAINTENANCE.

We have combined practicality with style to ensure daily maintenance is speedy, straightforward and simple, taking the stress out of maintaining your tractor, getting you to the field earlier for greater productivity and giving you some free time. With a Massey Ferguson MF 8S Series tractor, time spent in the yard preparing for the day ahead is kept to a minimum.

OPTIONS & ACCESSORIES

Today's farming demands machinery that is optimised to your business. Designed to tailor your Massey Ferguson machine to your needs, we offer a wide range of options and accessories – from loaders, weights, extra spool valves and hydraulic flowrates all the way through to auto-guidance technology. For your ultimate comfort there are seat upgrades, sound systems, drinks coolers and much more.

Everything we offer has been scrutinised by our engineers from all perspectives – optimum compatibility with your machine, safety, durability and performance. You'll get expert service from your Massey Ferguson dealer who has all the necessary installation tools and knowledge at their fingertips.



Engine air filter is easy to access and clean.



Easy access to remove the cab air filter for cleaning.



Front axle and slim waist bonnet design make oil dipstick and filter access easy.



Cooling package is easily accessible to make cleaning faster and easier.



Filling your fuel and AdBlue® tanks has never been easier.

MFservices

ALWAYS BY YOUR SIDE TO INCREASE YOUR PROFIT AND EFFICIENCY

WELCOME TO MF SERVICES – EVERYTHING YOU NEED TO SUPPORT THE OPERATION OF YOUR MF 8S TRACTOR.

Accessible and adaptable, MF Services will help you control running costs, budgeting and business planning - ensuring each machine's operating hour is a success and giving you the freedom to focus fully on the core business of farming.

This comprehensive suite of service-related-products makes it easier than ever to own and operate Massey Ferguson farm equipment.

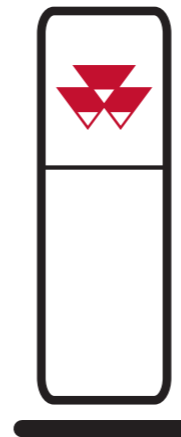

MASSEY FERGUSON DEALER NETWORK

Your MF dealer represents the best farm machines expertise in your area. You can always turn to your dealer and receive the best service from sales, maintenance, repair and spare parts to the purchase of a new piece of equipment.

MORE THAN 4,700 SERVICE & REPAIR POINTS WORLDWIDE



MASSEY FERGUSON GENUINE PARTS

REPRESENTS THE BEST GUARANTEE OF SAFEGUARDING THE VALUE OF YOUR NEW MF 8S OVER TIME, PROTECTING IT FROM UNPLANNED DOWNTIME.

Choose from an extensive range of accessories including lubricants, AdBlue, care kits, cab accessories and much more. All accessories are available for purchase exclusively from your MF dealer.

Using the smartphone app "AGCO Parts Books to go", you can find MF spare parts quickly and easily and order them directly. The app is available for download in the App Store and in the Google Play Store. Your personal access data is available from your MF dealer.



AGCO FINANCE

PROVIDES THE PERFECT FINANCING ARRANGEMENT FOR YOUR BUSINESS.

AGCO Finance is the integrated financial services arm of Massey Ferguson offering tailor-made solutions to your own farm, which includes Leasing, Loan facilities, Hire purchase, Full service packages and Contract hire including the financing of MF Care extended warranty contracts.



MASSEY FERGUSON COLLECTION

NOW YOU CAN LOOK AS STYLISH AS YOUR MASSEY FERGUSON.

Looking for a cap to match your MF 8S... Or a stylish and durable overall to keep working? We have an exclusive range of high quality products to suit you, your farming activity, your family and your lifestyle.

To find out what we have available please login into our online Shop:

Shop.MasseyFerguson.Com

For the above support packages, country terms and conditions apply. Please note all packages may not be available in all markets.

Please check with your local MF Dealer/Distributor.

MAKE THE MF 8S YOUR OWN AND AS INDIVIDUAL AS YOUR FARM



A



B



D



C

	EFFICIENT	EXCLUSIVE
ENGINE		
6-cylinder AGCO POWER Stage 5	●	●
Engine with memorised speed control	●	●
HLA (Hydraulic Lash Adjustment)	●	●
Extra idle engine speed (750 rpm)	●	●
Engine Block Heater	○	○
TRANSMISSION		
Power Control shuttle	●	●
Right hand shuttle	●	●
A Multipad on Armrest	●	●
Dyna-7 - 40Km/h Super Eco - Speedmatching & Autodrive	●	●
Dyna-7 - 50Km/h Eco* - Speedmatching & Autodrive	○	○
Dyna E-Power - 40Km/h Super Eco - Speedmatching & Autodrive	●	●
Dyna E-Power - 50Km/h Eco* - Speedmatching & Autodrive	○	○
Creeper (Dyna-7)	○	○
4-speed cruise control	●	●
Dynamic Braking System	●	●
ParkLock	●	●
OPERATOR ENVIRONMENT		
Standard Air Conditioning with manual adjustment	●	-
Automatic Air Conditioning with multi-zone flow management	○	●
Roof hatch	●	●
Automatic Air Suspended Swivel Seat, heated, lateral damping	●	○
B Semi Leather Automatic Air Suspended Swivel Seat - heated, ventilated, lateral damping	○	●
Auxiliary Seat with Seatbelt	●	●
Mechanical cab suspension	●	○
Active mechanical cab suspension	○	●
Radio/Front Aux-in/Bluetooth/USB connector - with integrated microphone - Controls in armrest	●	●
Radio/Front Aux-in/Bluetooth/USB connector/DAB+ - with integrated microphone - Controls in armrest	○	○
Telescopic Wide Angle Mirrors with Electrical de-icing & Adjustment	○	●
Right hand side wash wipe	○	○
De-icing system on rear window	○	○
Adjustable Steering Column with Memory tilt	●	○
Adjustable Steering Column with Memory tilt & SpeedSteer	○	●
Radar and slip control	○	●
C Digital MF vDisplay	●	●
D Datatronic 5 touchscreen terminal 9" (Tractor settings management, ISOBUS, camera ready & MF Guide compatible)	○	●
Fieldstar 5 touchscreen terminal 9" (ISOBUS, camera ready & MF Guide compatible)	○	○
Trailer steering axle management	○	●
Dual Control	○	●
Headland Management System	○	●

- Not available
- Standard specification
- Optional
- * Depending on market legislation

	EFFICIENT	EXCLUSIVE
TECHNOLOGY		
ISOBUS capability & rear connector	○	●
Front ISOBUS plug	○	○
MF Guide Ready	○	●
MF Guide Novatel SM / CM NTRIP / CM Radio & NTRIP with Go Mode	○	○
MF Guide Trimble SM / CM NTRIP / CM Radio & NTRIP with Go Mode	○	○
36 section control and VRC (5 Products)	○	○
Advanced Guidance line - single wayline and contour segments	○	○
E Integrated roof camera	○	●
TaskDoc Pro	○	○
Connect Telemetry with 5 year free subscription	●	●
CHASSIS AND HYDRAULICS		
Full mechanical controls of spool valves	○	-
Electrical and mechanical controls of spool valves	●	-
Electrical controls of spool valves with decompression lever	-	●
Efficient electrohydraulic Multifunction Joystick	○	-
Exclusive electrohydraulic Joystick	-	○
Micro joystick on Multipad	●	○
Loader subframe, electrical valve and joystick	○	○
Loader subframe & Hydraulic Kit SMS 3 rd Live	○	○
Free return	○	●
Power Beyond with couplers P/T/LS/D	○	●
150 l/min CCLS	●	●
205 l/min CCLS	○	○
F 205 l/min CCLS ECO	○	○
Electronic linkage controls with Active Transport Control	●	●
Auto PTO function	●	●
Electric PTO speed selection	●	●
Auto 4-Wheel-Drive and Auto DiffLock functions	●	●
Telescopic stabilisers	●	●
Automatic stabilisers	○	○
Hydraulic top link	○	○
Integrated front linkage system	○	○
Integrated Front PTO	○	○
ELECTRICAL EQUIPMENT		
Isolator Switch & Jump Start Post	●	●
External lift control on fenders	●	●
External PTO start/stop control on fender	●	●
External remote valve control on fender	●	●
G 16 LED worklights with signature lights	○	●
Automatic rear lights when reversing	-	●
OTHER EQUIPMENT (SPECIFICATIONS MAY VARY BY MARKET)		
Suspended front axle with locking	●	●
Pivoting front fenders	○	●
Pneumatic trailer brakes	●	●
Pneumatic and single line hydraulic trailer brakes with ABS socket	○	○



E



F



G

TECHNICAL SPECIFICATIONS

Engine		MF 8S.205	MF 8S.225	MF 8S.245	MF 8S.265
Engine Type		AGCO POWER			
No. of cylinders/no. of valves/Capacity	No./No./cm³	6 / 4 / 7,400			
Bore / Stroke	mm/mm	108/134			
Aspiration		Turbo with electrical wastegate and intercooler			
Injection type		Common rail			
Fan type		Viscotronic			
Maximum hp	⊕ ISO hp (kW)	205(151)	225(165)	245(180)	265(195)
Engine rpm at maximum hp	rpm	1,850			
Maximum torque 1,000–1,500 rpm	⊕ Nm	950	1,000	1,100	1,200
Maximum power with EPM	hp (kW)	225(165)	245(180)	265(195)	285(210)
Maximum torque with EPM 1,000–1,500 rpm	Nm	982	1,080	1,178	1,257
Max. power available @ PTO shaft (OECD, accuracy +/- 3%)	hp (kW)	186(137)	199(146)	216(159)	231(170)
Fuel tank capacity	litres	460			
AdBlue® tank capacity	litres	43			
Service interval	hours	600			
Dyna-7 Transmission					
Number of gears	fwd/rev	28/28			
Min. speed @ 1,500 rpm	km/h	1.8			
No. of speeds with creeper	fwd/rev	56/56			
Min. speed with creeper		190 m/h @ 1,500 rpm			
43 km/h SuperEco @ engine speed	rpm	1,350			
53 km/h* Eco @ engine speed	rpm	1,650			
Dyna E-Power Transmission					
Number of gears	fwd/rev	28/28 in Autodrive			
Min. speed @ 1,500 rpm	km/h	1.9			
43 km/h SuperEco @ engine speed	rpm	1,300			
53 km/h* Eco @ engine speed	rpm	1,600			

Every effort has been made to ensure that the information contained in this publication is as accurate and current as possible. However, inaccuracies, errors or omissions may occur and details of the specifications may be changed at any time without notice. Therefore, all specifications should be confirmed with your Massey Ferguson Dealer or Distributor prior to any purchase.

		MF 8S.205	MF 8S.225	MF 8S.245	MF 8S.265
Rear Linkage and Hydraulics					
Lower links type	CAT	Cat 3			
Maximum lift capacity, at link end	kg	10,000			
Hydraulic type & max flow	l/min	Closed Centre Load Sensing 150 l/min			
Hydraulic type & max flow - Option 1	l/min	Closed Centre Load Sensing 205 l/min			
Hydraulic type & max flow - Option 2	l/min	Closed Centre Load Sensing 205 Eco 205 l/min @ 1,650 rpm			
Maximum pressure	Bars	200			
Maximum no. of rear spool valves		5			
Power Take-Off (Rear)					
Engine speed					
	rpm	1,867 / 1,499 / 1,903 / 1,528			
	Inches	1 3/8" 6 & 21 splines			
Front linkage and Front Power Take-Off					
Maximum lift capacity, at link end	kg	4,800			
Maximum no. of front spool valves		2			
Engine speed at 1,000 front PTO speed	rpm	1,920			
Wheels and Tyres (Full range available. Please consult your Dealer)					
	Front	VF 600/70 R30			
	Rear	VF 650/75 R42			
Weights (May vary depending on configuration. Please consult your Dealer)					
Average minimum weight with no ballast, no accessories	kg	8,700			
Maximum Gross vehicle weight*	kg	16,000			

⊕ ISO 14396 - Not available * Depending on market legislation

DIMENSIONS

		MF 8S (all models)
A	Wheelbase	m 3.05
B	Overall length from front linkage to rear linkage arms	mm 5,375
C	Height at centre of rear axle to the top of MF Connect antennas	mm 2,390
D	Total height	mm 3,390





www.MasseyFerguson.co.uk

www.facebook.com/masseyfergusonUK

[Twitter.com/MF_EAME](https://twitter.com/MF_EAME)

[Instagram.com/MasseyFergusonGlobal](https://www.instagram.com/MasseyFergusonGlobal)

www.YouTube.com/MasseyFergusonGlobal



MASSEY FERGUSON® is a worldwide brand of AGCO.
© AGCO SAS. 2021 | A-A-17256 | English



MASSEY FERGUSON