



PARTS BREAKDOWN

AIR COMPRESSOR

MODEL:AC658HB



BEPOWEREQUIPMENT

.COM



PARTS BREAKDOWN AIR COMPRESSOR

MODEL:AC658HB

PUMP AND PLUMBING

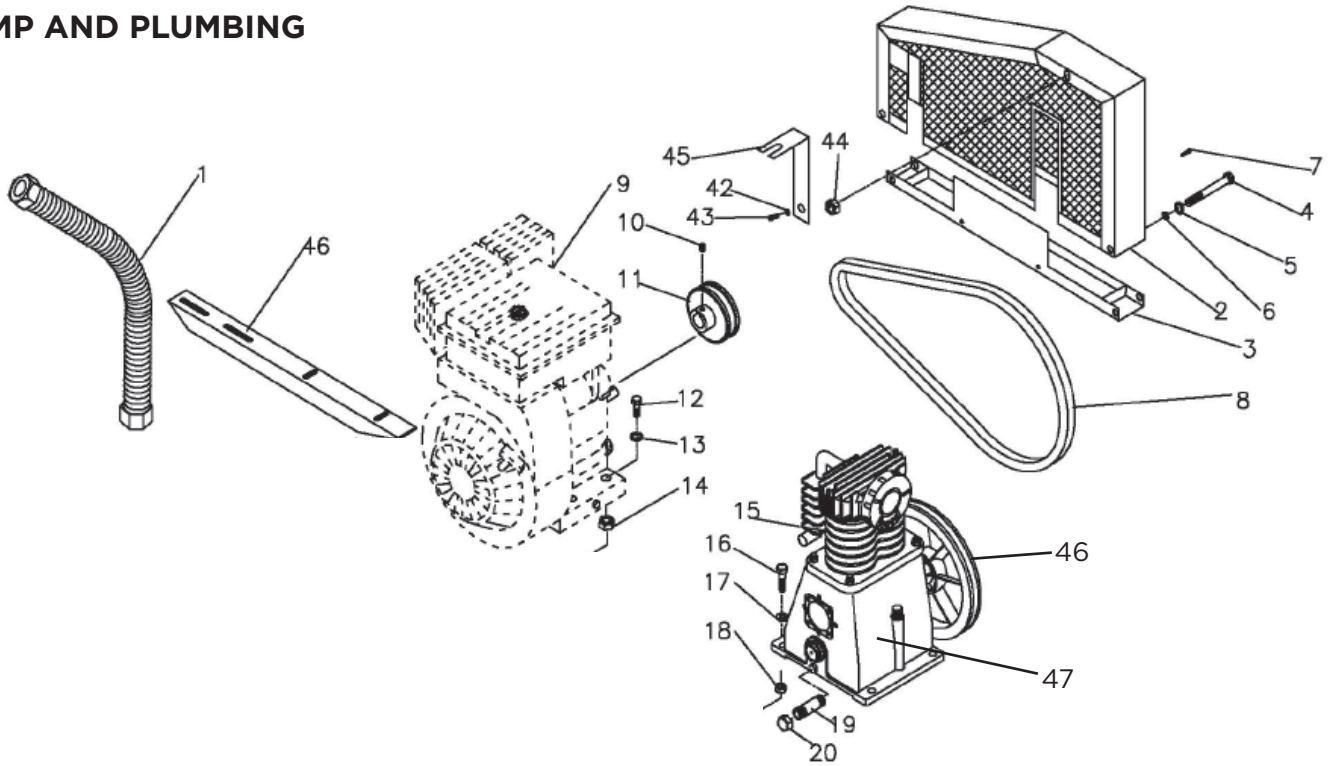

REF #	DESCRIPTION	QTY	BE PART #
1	Steel Braided Discharge Pipe	1	42.004.020
2	Belt Guard Assembly	1	42.008.013
8	Belt	1	42.004.021
11	Motor Pulley	1	42.004.029
45	Belt Gaurd Bracket	1	42.004.032
46	Pump Pulley	1	42.008.010
47	Complete Pump Assembly (includes Pulley)	1	42.004.022
9	*Honda GX200 Engine	1	Check with Honda

***CHECK WITH HONDA FOR ENGINE BREAKDOWN AND PARTS**



PARTS BREAKDOWN AIR COMPRESSOR

MODEL:AC658HB

MANIFOLD ASSEMBLY

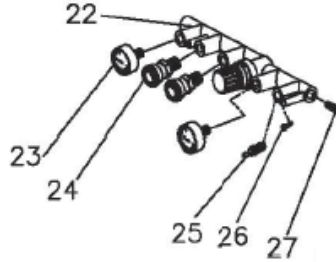

REF #	DESCRIPTION	QTY	BE PART #
22	Bare Manifold	1	42.004.023
23	Pressure Gauge	2	42.004.031
24	Quick Couplers	2	42.000.047
25	Safety Valve	1	42.006.009
22-27	Complete Manifold Assembly	1	42.004.011

TANK ASSEMBLY

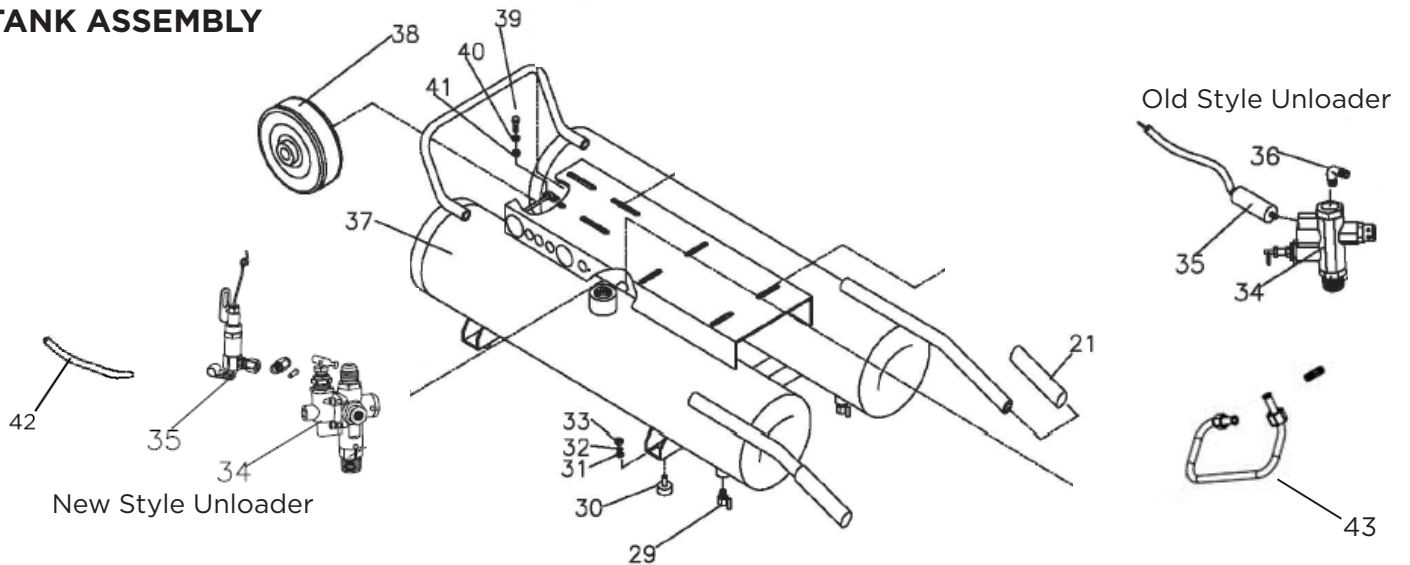

REF #	DESCRIPTION	QTY	BE PART #
38	Wheel	1	42.004.010
29	Tank Drain Valve	2	42.004.025
30-33	Rubber Foot Replacment Kit (each)	4	85.660.007BT
34	Pilot Unloader Valve	1	42.010.024
35	Engine Throttle Control	1	42.010.026
42	Engine Throttle Hose	1	42.010.029
34,35,42	Unloader Replacement Kit*	1	42.010.044
43	Pipe, Manifold to Air Tanks	1	42.004.024

*Old style units had wire actuated throttle cables. New version is pneumatic actuated. Replacemnt kit upgrades old style into new.



PARTS BREAKDOWN AIR COMPRESSOR

MODEL:AC658HB

PUMP ASSEMBLY

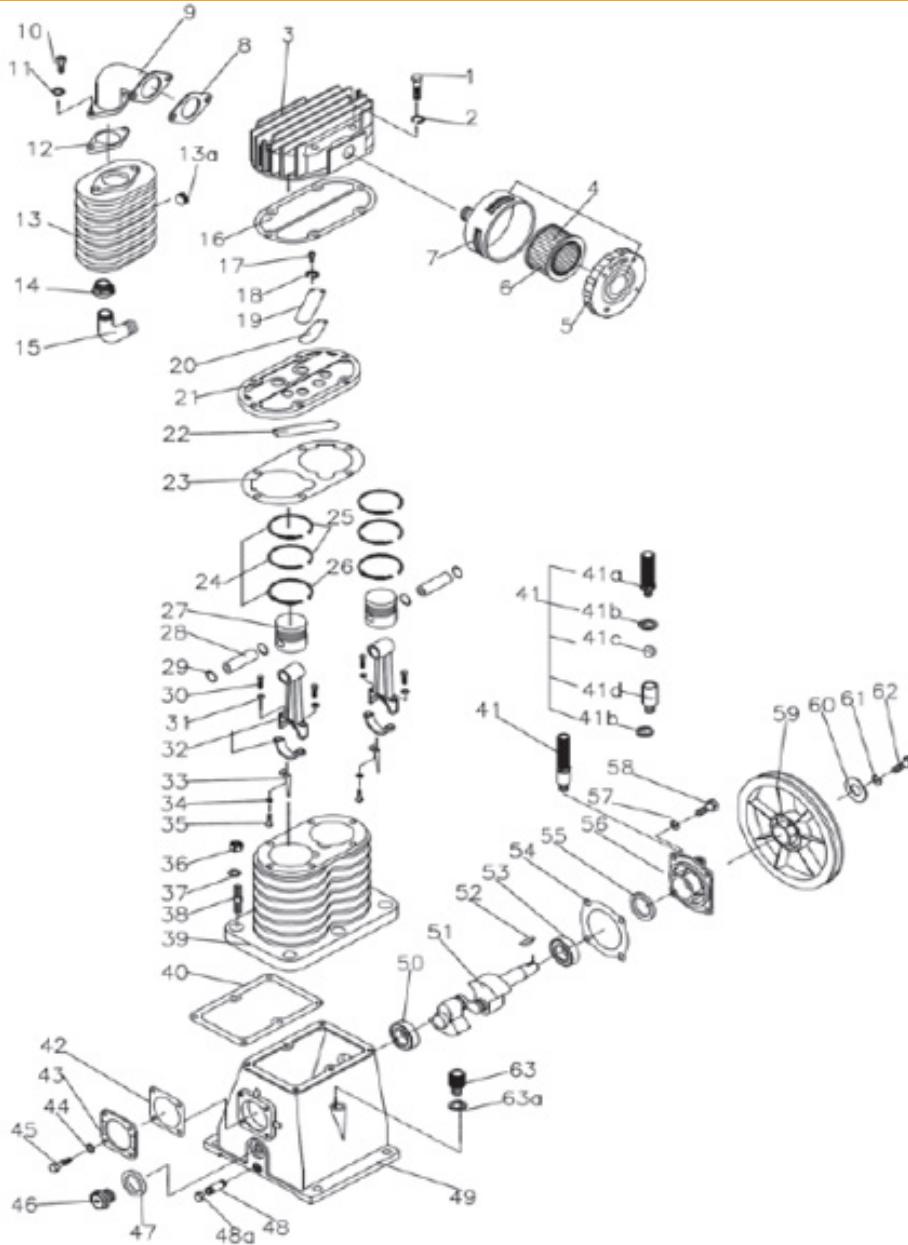

REF #	DESCRIPTION	QTY	BE PART #
3	Cylinder Head	1	42.008.009
4	Air Filter Assembly	1	42.004.028
16	Cylinder Head Gasket	1	42.008.014
41	Breather Assembly	1	42.004.030
59	Pump Pulley	1	42.008.010
63	Oil Breather Plug	1	42.008.011
63a	Oil Breather Plug Washer	1	42.008.012
**	Complete Pump Assembly	1	42.004.022



PARTS BREAKDOWN AIR COMPRESSOR

MODEL:AC658HB

COMPLETE ASSEMBLY
(FOR REFERENCE)

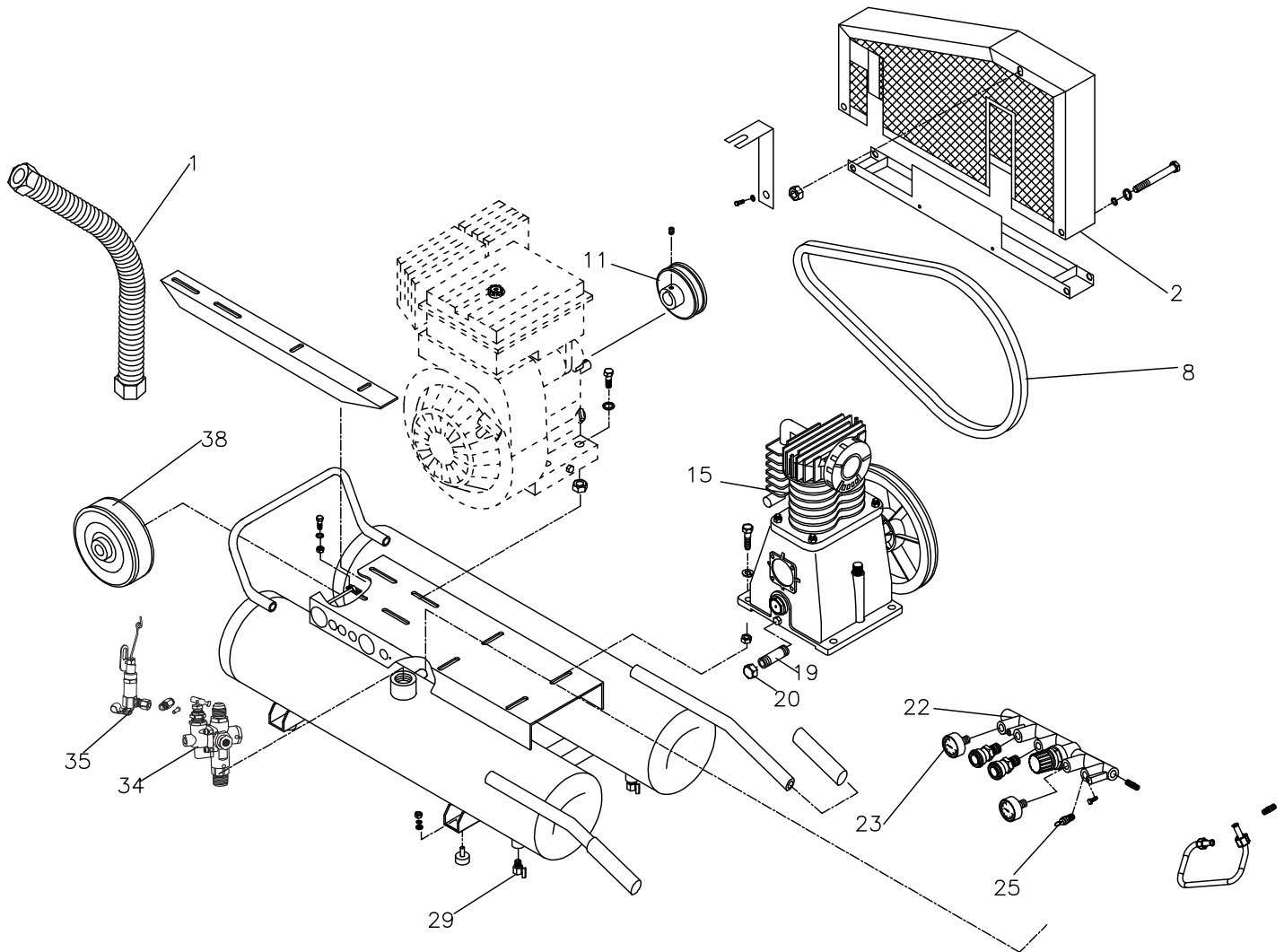

BE

POWER EQUIPMENT

If you need technical assistance call:

1-866-850-6662

(8:00am - 4:30pm PST, Mon - Fri)