

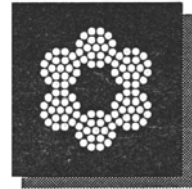

HEAD OFFICE 20 ARTHUR STREET NORTH, ELMIRA, ONTARIO N3B 1Z9
 TEL: (519) 669-4025 FAX: (519) 669-1436
ORDER DESK e-mail: orders@walcoequipment.com
 TEL: (519) 669-1401 FAX (519) 669-3499
QUEBEC OFFICE 364 RTE.122 ST.GERMAIN DE GRANTHAM, QUÉBEC J0C 1K0
 TEL: (819) 395-5115 Fax (819) 395-2624
 e-mail: walcogc@walcoequipment.com

WIRE ROPE – BRIGHT - 6 X 19 - FIBRE CORE

ITEM #	DIAMETER	IPS B/S		WEIGHT	
		Tons	Lbs./Ft.	\$ /100 Ft.	
605250	1/4"	2.7	.10		Call for Pricing
	5/16"	4.1	.16		Call for Pricing
	3/8"	6	.23		
605264	7/16"	8	.31		
	1/2"	11	.40		
	9/16"	13	.51		
605265	5/8"	16	.63		Call for Pricing
	3/4"	23	.90		
	7/8"	32	1.23		Call for Pricing
	1"	41	1.60		
	1-1/8"	53	2.03		Call for Pricing
	1-1/4"	65	2.50		Call for Pricing
	1-3/8"	81	3.03		
	1-1/2"	96	3.60		



6 X 25 C - FIBRE CORE

605255	1/2"	11	.40		
	1/2"	11	.40	2500' Roll	

6 X 19 - IWRC

ITEM #	DIAMETER	IPS B/S		WEIGHT		LIST PRICE
		Tons	Lbs./Ft	\$/100 Ft.		
605252	1/4"	2.9	.11		Call for Pricing	
	5/16"	4.4	.17		Call for Pricing	
	3/8"	6.4	.25			
605276	7/16"	8.6	.34			
605263	1/2"	11.8	.44			
	9/16"	14.3	.56			
605266	5/8"	17.7	.69			
605268	3/4"	25.5	.99			
605275	7/8"	34.4	1.35			
605352	1"	44.8	1.76			
	1-1/8"	56.9	2.23		Call for Pricing	
	1-1/4"	70.4	2.75			
	1-3/8"	87.0	3.33		Call for Pricing	
	1-1/2"	103.2	3.96			

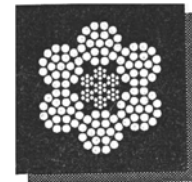

6 X 25 - IWRC

ITEM #	DIAMETER	IPS B/S	WEIGHT	LIST PRICE/100 FT.
605253	3/8"			
	3/8"			2500' Roll
605256	1/2"	11.8	.44	

6 X 26 - IWRC

ITEM #	DIAMETER	IPS B/S	WEIGHT	LIST PRICE/100 FT.
605257	1/2"			2500' Roll

"Reel quantity" prices. Add \$7.00 per reel for all quantities less than 5,000 feet.

6 x 37 – IWRC - BRIGHT

ITEM #	DIAMETER	ISP B/S		WEIGHT		LIST PRICE
		TONS	LBS./FT.	\$ /100 FT.		
	1/4"	2.6	.11		Call for Pricing	
	5/16"	4.3	.17		Pricing	
	3/8"	5.9	.24			
605269	7/16"	8.0	.33			
	1/2"	10.7	.43			
	9/16"	13.4	.54			
605270	5/8"	17.2	.67			
	3/4"	23.8	.96			
	7/8"	32.4	1.31			
	1"	42.4	1.70		Call for Pricing	
	1-1/8"	52.6	2.16		Pricing	
	1-1/4"	65.5	2.66			
	1-3/8"	80.0	3.22			
	1-1/2"	96.7	3.84			

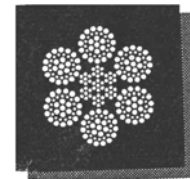

ALL PRICES SUBJECT TO CHANGE WITHOUT NOTICE



HEAD OFFICE 20 ARTHUR STREET NORTH, ELMIRA, ONTARIO N3B 1Z9
 TEL: (519) 669-4025 FAX: (519) 669-1436

ORDER DESK e-mail: orders@walcoequipment.com
 TEL: (519) 669-1401 FAX (519) 669-3499

QUEBEC OFFICE 364 RTE.122 ST.GERMAIN DE GRANTHAM, QUÉBEC J0C 1K0
 TEL: (819) 395-5115 Fax (819) 395-2624
 e-mail: walcocq@walcoequipment.com

SECTION
5

Page 2

6 X 37 - FIBRE CORE

ITEM #	DIAMETER	ISP B/S TONS	WEIGHT LBS./FT.	LIST PRICE \$/100 FT.
	1/4"	2.5	.10	
	5/16"	4.0	.16	Call for Pricing
	3/8"	5.5	.22	
	7/16"	7.5	.30	
	1/2"	10.0	.39	
	9/16"	12.5	.49	
	5/8"	16.0	.61	
	3/4"	22.2	.87	
	7/8"	30.2	1.19	
	1"	39.5	1.55	
	1-1/8"	49.0	1.96	
	1-1/4"	61.0	2.42	
	1-3/8"	74.5	2.93	
	1-2/2"	90.0	3.49	



18 x 7 - ISP - ROTATION RESISTANT

ITEM #	DIAMETER	NBS B/S 110/120	WEIGHT LBS./FT.	LIST PRICE \$ 100 FT.
	1/4"	2.5	.10	
	5/16"	3.8	.17	Call for Pricing
	3/8"	5.6	.24	
	7/16"	7.6	.33	
605262	1/2"	9.8	.43	
	9/16"	12.4	.55	
605267	5/8"	15.3	.68	
	3/4"	21.8	.97	

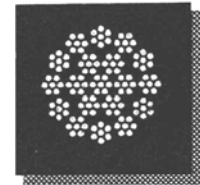
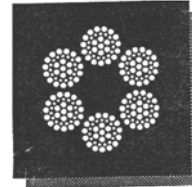

6 x 19 - IWRC - SWAGGED - FOR LOGGING

ITEM #	DIAMETER SWAGGED	ISP B/S TONS	WEIGHT LBS./FT.	LIST PRICE \$ / 100FT.
	1/2"	15.9	.57	
	9/16"	19.3	.79	
605272	5/8"	24.5	.97	
	11/16"	29.6	1.18	

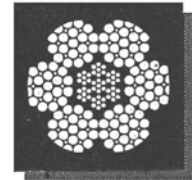

AIRCRAFT CABLE - 7 X 7 CONSTRUCTION - GALVANIZED

ITEM #	DIAMETER	NOM B/S LBS.	WEIGHT LBS./1000'	LIST PRICE \$ /1000 FT.
605220	1/16"	480	7.5	
605221	3/32"	920	16.0	
605222	1/8"	1,700	28.5	
605223	3/16"	3,700	62	

On 5000 m 2500 ft. Reels

"Reel quantity" prices.

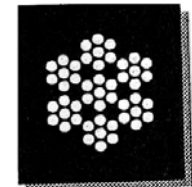

7 X 19 CONSTRUCTION

ITEM #	DIAMETER	NOM.B/S LBS.	WEIGHT LBS./1000'	LIST PRICE \$ /1000 FT.
605205	1/8"	2,000	29	
605204	3/16"	4,200	65	
605207	1/4"	7,000	110	
605208	5/16"	9,800	173	
605211	3/8"	14,400	243	
605212	1/2"	19,140	440	

On 5000 m 2500 ft. Reels

"Reel quantity" prices.

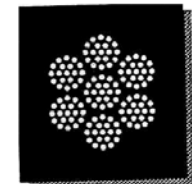

7 X 7 CONSTRUCTION - GALVANIZED COATED

ITEM #	DIAMETER	COATING	NOM.B/S LBS.	WT. LBS./M'	LIST PRICE \$ /1000 FT.
605202	1/8" 3/16"	Clear PVC	1700	37	

ALL PRICES SUBJECT TO CHANGE WITHOUT NOTICE

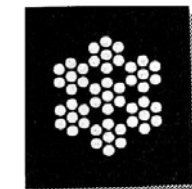

AIRCRAFT CABLE Designed for industrial and marine use only!

DISTRIBUTED BY WALCO EQUIPMENT WHERE SAFETY AND SERVICE COME FIRST



HEAD OFFICE 20 ARTHUR STREET NORTH, ELMIRA, ONTARIO N3B 1Z9
 TEL: (519) 669-4025 FAX: (519) 669-1436

ORDER DESK e-mail: orders@walcoequipment.com
 TEL: (519) 669-1401 FAX (519) 669-3499

QUEBEC OFFICE 364 RTE.122 ST.GERMAIN DE GRANTHAM, QUÉBEC J0C 1K0
 TEL: (819) 395-5115 Fax (819) 395-2624
 e-mail: walcoqc@walcoequipment.com

2015

AIRCRAFT CABLE 7 X 19 CONSTRUCTION - GALVANIZED COATED

ITEM #	DIAMETER		COATING	NOM.B/S	WT.	
	CABLE	COATING			LBS.	LBS./M'
605351	1/8"	3/16"	Clear PVC	2000		37
605226	1/4"	3/16"	Black PVC	2000		37
605467	3/16"	1/4"	Clear PVC			76

Add \$10.00 per reel for all quantities less than 5,000 feet. "Reel quantity" prices.

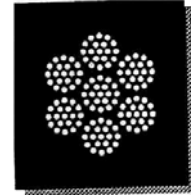

7 X 19 CONSTRUCTION – GALVANIZED – 250' REEL

ITEM #	DIAMETER
605540	1/8
605541	3/16
605542	1/4
605543	5/16
605544	3/8



7 X 19 CONSTRUCTION – GALVANIZED – 1000' REEL

ITEM #	DIAMETER
605551	3/16
605552	1/4
605550	5/16
605553	3/8

**AIRCRAFT CABLE - STAINLESS STEEL - TYPE 302/304
7 X 7 CONSTRUCTION**

ITEM #	DIAMETER	NOM B/S		WEIGHT	
		Lbs.	Lbs./1000'	\$ / 1000 Ft.	
605229	3/64"	270	4.2		
	1/16"	480	7.5		
	3/32"	920	16.0		Call for Pricing
	1/8"	1,700	28.5		



7 X 19 CONSTRUCTION

ITEM #	DIAMETER	NOM B/S		WEIGHT	
		Lbs.	Lbs./1000'	\$ / 1000 Ft.	
605228	3/32"	1,050	16		
605230	1/8"	1,760	29		
605227	5/32"	2,400	45		
605231	3/16"	3,700	65		
605232	1/4"	6,400	110		
605233	5/16"	9,000	173		
605235	3/8"	12,000	243		
	3/8"	12,000	243		2500" Roll



1 X 19 CONSTRUCTION

ITEM #	DIAMETER	NOM B/S		WEIGHT	
		Lbs.	Lbs./1000'	\$ / 1000 Ft.	
605239	1/4"	8,200	135		

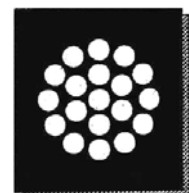

**AIRCRAFT CABLE - STAINLESS STEEL - COATED
7 X 7 SSAC CONSTRUCTION WHITE PVC**

ITEM #	DIAMETER		NOM.B/S	WEIGHT	
	Cable/Coating			Lbs.	Lbs./M'
605234	1/16"	3/32"	480	9.3	
	3/32"	1/8"	920	19	
	3/32"	5/32"	920	24	Call for Pricing
605469	1/8"	3/16"	1700	42	
	1/8"	1/4"	1700	4	
	3/16"	5/16"	3700	92	Call for Pricing

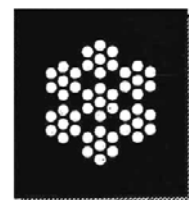

"Reel quantity" prices. Add \$10.00 per reel for all quantities less than 5,000 feet.

ALL PRICES SUBJECT TO CHANGE WITHOUT NOTICE



HEAD OFFICE 20 ARTHUR STREET NORTH, ELMIRA, ONTARIO N3B 1Z9
 TEL: (519) 669-4025 FAX: (519) 669-1436

ORDER DESK e-mail: orders@walcoequipment.com
 TEL: (519) 669-1401 FAX (519) 669-3499

QUEBEC OFFICE 364 RTE.122 ST.GERMAIN DE GRANTHAM, QUÉBEC J0C 1K0
 TEL: (819) 395-5115 Fax (819) 395-2624
 e-mail: walcoqc@walcoequipment.com

SECTION
5

MALLEABLE WIRE ROPE CLIPS – GALVANIZED

ITEM #	SIZE CABLE DIA.	WEIGHT/LBS. PER/100
503418	1/8"	4
503419	3/16"	6
503420	1/4"	10
503421	5/16"	12
503422	3/8"	23
503423	1/2"	40
503424	5/8"	55
503425	3/4"	82
503427	7/8"	125
503428	1"	150
503429	1-1/8"	250



WIRE ROPE CLIPS - FORGED

ITEM #	SIZE CABLE DIA.	WEIGHT/LBS. PER/100
503413	3/16"	10
503414	1/4"	17
503415	5/16"	28
503440	3/8"	40
503432	7/16"	
503441	1/2"	65
503442	5/8"	95
503416	3/4"	140
503443	7/8"	215



WIRE ROPE CLIPS - STAINLESS STEEL (T316)

ITEM #	SIZE CABLE DIA.	WEIGHT/LBS. PER/100
617204	1/8" - 5/32"	4
617205	3/16"	8
617206	1/4"	9
617208	5/16"	17
617210	3/8"	35
617213	1/2"	48

WIRE ROPE THIMBLES – GALVANIZED / ZINC

ITEM #	CABLE SIZE DIA./INCHES	WEIGHT/LBS. PER/100
604318	1/8	2.2
604319	3/16	2.5
604320	1/4	2.5
604322	5/16	4.4
604324	3/8	7.6
604326	1/2	11.3
604328	5/8	30.0
604329	3/4	37.0
	7/8	73.0
	1	100.0



HEAVY DUTY THIMBLES - TYPE 3

ITEM #	CABLE SIZE DIA./INCHES	WEIGHT/LBS. PER/100
604332	1/4"	8
604333	5/16"	14
604334	3/8"	44
604335	1/2"	74
604336	5/8"	115
604330	3/4"	150
604338	7/8"	225
	1"	336



HEAD OFFICE 20 ARTHUR STREET NORTH, ELMIRA, ONTARIO N3B 1Z9
 TEL: (519) 669-4025 FAX: (519) 669-1436

ORDER DESK e-mail: orders@walcoequipment.com
 TEL: (519) 669-1401 FAX (519) 669-3499

QUEBEC OFFICE 364 RTE.122 ST.GERMAIN DE GRANTHAM, QUÉBEC J0C 1K0
 TEL: (819) 395-5115 Fax (819) 395-2624
 e-mail: walcoqc@walcoequipment.com

2015

SPRING SNAP LINK - ZINC PLATED

ITEM #	SIZE	PKG.	WEIGHT LBS/100
605172	3/16"	Bulk	4
605173	1/4"	Bulk	5
605174	5/16"	Bulk	15
605178	3/8"	Bulk	20
605181	1/2"	Bulk	60

All prices subject to change without notice.



SWAGE SLEEVES ALUMINUM

ITEM #	CABLE DIA./ INCHES	TYPE
604360	1/16	Oval
604363	1/16	Stop
604362	3/32	Oval
604375	3/32	Stop
604367	1/8	Oval
604365	1/8	Stop
604366	3/16	Oval
604364	3/16	Stop
604368	3/16	Spools
604369	1/4	Oval
604376	1/4	Stop
604370	5/16	Oval
604371	3/8	Oval

COPPER SWAGE SLEEVES AVAILABLE

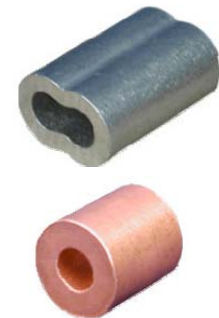

SWAGING TOOLS

FOR ALUMINUM AND COPPER TOOLS

ITEM #	MODEL	LENGTH	WEIGHT
	#1 HSC 600	26"	6.5 lbs.
	#1 HS 600 B	20"	6.5
Call for Pricing			
Jaw Set for Bench			

WIRE ROPE CUTTERS - IMPACT TYPE

ITEM #	CAPACITY
605200	1 5/8"
	1 A 1-1/16"
	2 1-1/2"
Call for Pricing	

WIRE ROPE & CABLE CUTTERS "ECONO LINE"

ITEM #	MODEL	LENGTH	WEIGHT
	C-7	8"	0.63
	C-9	13"	1.63
Call for Pricing			

ALL PRICES SUBJECT TO CHANGE WITHOUT NOTICE





HEAD OFFICE 20 ARTHUR STREET NORTH, ELMIRA, ONTARIO N3B 1Z9
 TEL: (519) 669-4025 FAX: (519) 669-1436

ORDER DESK e-mail: orders@walcoequipment.com
 TEL: (519) 669-1401 FAX (519) 669-3499

QUEBEC OFFICE 364 RTE. 122 ST. GERMAIN DE GRANTHAM, QUÉBEC JOC 1K0
 TEL: (819) 395-5115 Fax (819) 395-2624
 e-mail: walcoqc@walcoequipment.com

**WIRE ROPE
2 LEG SLING**



DIAMETER INCHES	60°	45°	30°
1/4	2,210	1,820	1,300
5/16	3,400	2,800	2,000
3/8	4,760	3,920	2,800
7/16	6,460	5,320	3,800
1/2	8,500	7,000	5,000
9/16	10,880	8,960	6,400
5/8	13,260	10,920	7,800
3/4	19,040	15,680	11,200
7/8	25,840	21,280	15,200
1	33,320	27,440	19,600
1-1/8	40,800	33,600	24,000
1-1/4	51,000	42,000	31,000

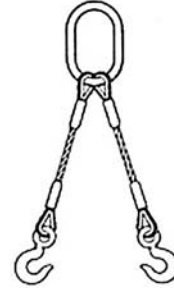

3 LEG SLING

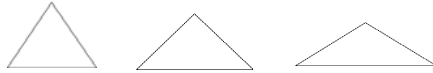

DIAMETER INCHES	60°	45°	30°
1/4	3,400	2,800	1,940
5/16	5,200	4,200	3,000
3/8	7,400	5,000	4,400
7/16	10,000	8,200	5,800
1/2	13,200	10,800	7,600
9/16	16,600	13,600	9,600
5/8	20,000	16,600	11,800
3/4	30,000	24,000	16,800
7/8	40,000	32,000	22,000
1	52,000	42,000	30,000
1-1/8	62,000	52,000	36,000
1-1/4	76,000	62,000	44,000

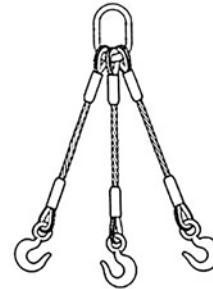

4 LEG SLING

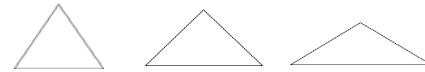

DIAMETER INCHES	60°	45°	30°
1/4	4,400	3,600	2,600
5/16	7,000	5,600	4,000
3/8	10,000	8,200	5,800
7/16	13,400	11,000	7,800
1/2	17,600	14,200	10,200
9/16	22,000	18,000	12,800
5/8	28,000	22,000	15,600
3/4	38,000	32,000	22,000
7/8	52,000	42,000	30,000
1	68,000	56,000	40,000
1-1/8	84,000	68,000	48,000
1-1/4	102,000	84,000	60,000

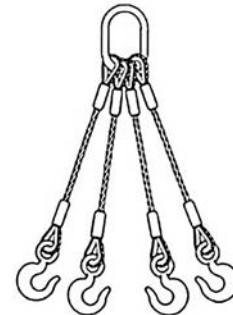

DIAMETER INCHES	VERTICAL	CHOKER	BASKET
1/4	1,300	960 lb.	2,600
5/16	2,000	1,400	4,000
3/8	2,800	2,200	5,800
7/16	3,800	2,800	7,800
1/2	5,000	3,800	10,200
9/16	6,400	4,800	12,800
5/8	7,800	5,800	15,600
3/4	11,200	8,200	22,000
7/8	15,200	11,200	30,000
1	19,600	14,400	40,000
1-1/8	24,000	18,200	48,000
1-1/4	30,000	22,000	60,000
1-1/2	42,000	32,000	84,000

VERTICAL CHOKER BASKET



DO NOT EXCEED LIFT CAPACITY



HEAD OFFICE 20 ARTHUR STREET NORTH, ELMIRA, ONTARIO N3B 1Z9
 TEL: (519) 669-4025 FAX: (519) 669-1436

ORDER DESK e-mail: orders@walcoequipment.com
 TEL: (519) 669-1401 FAX (519) 669-3499

QUEBEC OFFICE 364 RTE.122 ST.GERMAIN DE GRANTHAM, QUÉBEC J0C 1K0
 TEL: (819) 395-5115 Fax (819) 395-2624
 e-mail: walcoqc@walcoequipment.com

STEEL WIRE ROPE
Steel Core (IWRC)

SINGLE LEG STANDARD
LOOP WIRE ROPE SLINGS

6 x 26 ws Mechanically Spliced
 Eyes Each End
 Other Configurations
 Available on Request.

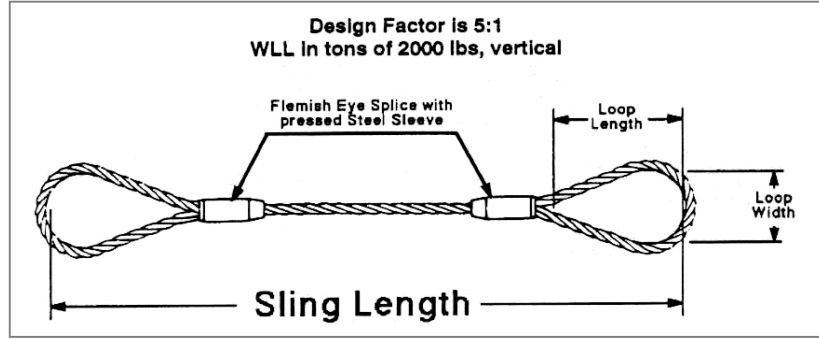

PRICE FOR EACH SLING WITH STEEL CORE, READY TO USE

Loop Size*	4 x 2	4 x 2	8 x 4	10 x 5	12 x 6	14 x 7
Sling Dia.	1/4"	3/8"	1/2"	5/8"	3/4"	7/8"
WLL Tons	.65	1.4	3.2	3.9	5.6	7.6

LENGTH

3 Ft.					N/A	N/A
4 Ft.						

5 Ft.
 6 Ft.

8 Ft.
 10 Ft.
 12 Ft.

15 Ft.
 20 Ft.

Prices subject to change without notice. *Loop Length x Width in inches Multi-Leg Bridle Slings available on request

STEEL WIRE ROPE
STEEL CORE (IWRC)

SINGLE LEG STANDARD
LOOP WIRE ROPE SLINGS

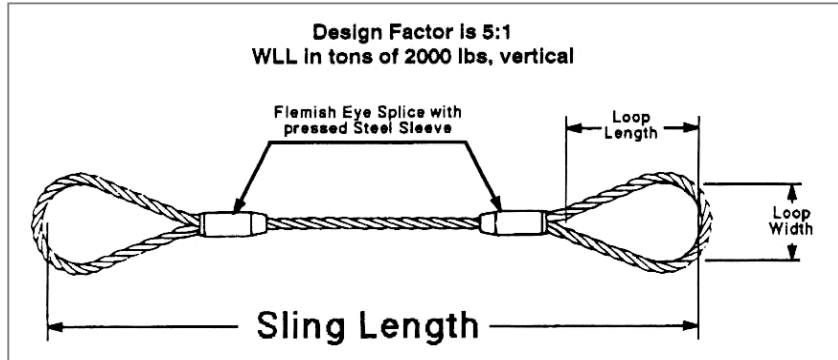

PRICE FOR EACH SLING WITH STEEL CORE, READY TO USE

LOOP SIZE*	16 X 8	18 X 9	20 X 10
SLING DIA.	1"	1-1/8"	1-1/4"
WLL TONS	9.8	12	15

LENGTH

5 Ft.			N/A
6 Ft.			

8 Ft.
 10 Ft.

12 Ft.
 15 Ft.

20 Ft.

*Loop Length x Width in inches Multi-Leg Bridle Slings available on request. ALL PRICES SUBJECT TO CHANGE WITHOUT NOTICE



HEAD OFFICE 20 ARTHUR STREET NORTH, ELMIRA, ONTARIO N3B 1Z9
 TEL: (519) 669-4025 FAX: (519) 669-1436

ORDER DESK e-mail: orders@walcoequipment.com
 TEL: (519) 669-1401 FAX (519) 669-3499

QUEBEC OFFICE 364 RTE.122 ST.GERMAIN DE GRANTHAM, QUÉBEC J0C 1K0
 TEL: (819) 395-5115 Fax (819) 395-2624
 e-mail: walcoqc@walcoequipment.com

SECTION
5

2015

TURNBUCKLES - HOT GALVANIZED - DROP FORGED

ITEM #	SIZE	WLL/LBS.	WEIGHT
	DIA. X TAKE-UP	H&H-H&E	LBS.
605131	3/8 x 6"	1,000	.75
605148	1/2 x 6"	1,500	1.50
605013	1/2 x 9"	1,500	1.75
605132	1/2 x 12"	1,500	2.18
605133	5/8 x 6"	2,250	2.63
605134	5/8 x 9"	2,250	3.00
605149	5/8 x 12"	2,250	3.25
605135	3/4 x 6"	3,000	3.75
605136	3/4 x 9"	3,000	4.50
605137	3/4 x 12"	3,000	5.75
605138	7/8 x 12"	4,000	8.38
605139	7/8 x 18"	4,000	10.25
605140	1 x 12"	5,000	11.25
605141	1 x 18"	5,000	14.00
605143	1-1/4x12"	5,000	19.00
605144	1-1/4x18"	5,000	24.10

ITEM #	SIZE	WWL/LBS.	WEIGHT
	DIA. X TAKE-UP	E&E	LBS.
605219	3/8 x 6"	1,200	.75
	1/2 x 6"	2,200	1.50
605187	1/2 x 9"	2,200	1.75
605215	1/2 x 12"	2,200	2.18
605169	5/8 x 6"	3,500	2.63
605238	5/8 x 9"	3,500	3.00
605191	5/8 x 12"	3,500	3.25
605176	3/4 x 6"	5,200	3.75
605070	3/4 x 9"	5,200	4.50
605198	3/4 x 12"	5,200	5.75
605145	3/4 x 18"	5,200	7.00
605199	7/8 x 12"	7,200	8.38
605071	7/8 x 18"	7,200	10.25
605152	1 x 12"	10,000	11.25
605072	1 x 18"	10,000	14.00
605158	1-1/4x12"	15,200	19.00
605073	1-1/4x18"	15,200	24.10
605170	1-1/2x12"	21,400	27.00

ITEM #	SIZE	WLL/LBS.	WEIGHT
	DIA. X TAKE-UP	J & J	LBS.
605188	3/8 x 6"	1,200	.93
605214	1/2 x 6"	2,200	1.68
605186	1/2 x 9"	2,200	1.85
605189	1/2 x 12"	2,200	2.20
605192	5/8 x 6"	3,500	2.82
605193	5/8 x 9"	3,500	3.25
605190	5/8 x 12"	3,500	3.75
605194	3/4 x 6"	5,200	4.68
605195	3/4 x 9"	5,200	5.38
605196	3/4 x 12"	5,200	6.12
605197	3/4 x 18"	5,200	7.75
605075	7/8 x 12"	7,200	9.38
605076	7/8 x 18"	7,200	1.44
605180	1" x 6"	10,000	
605159	1 x 12"	10,000	12.88
605077	1 x 18"	10,000	16.10
605078	1 x 24"	10,000	18.60
605079	1-1/4x12"	15,200	23.6
605080	1-1/4x18"	15,200	26.6
605171	1-1/4 x 24"		

NOTE: All Turnbuckles with stop nuts

ALL PRICES SUBJECT TO CHANGE WITHOUT NOTICE

Hook & Hook



Eye & Eye



Jaw & Jaw

