

# OPERATOR'S MANUAL ENGINE CUT-OFF SAW

THIS PRODUCT COMPLIES WITH CAN ICES-2/NMB-2

## CSG-7410

### WARNING

The engine exhaust from this product contains chemicals known to the State of California to cause cancer, birth defects or other reproductive harm.

Cancer and Reproductive Harm  
[www.P65Warnings.ca.gov](http://www.P65Warnings.ca.gov)



### WARNING

Read the instructions carefully and follow the rules for safe operation.  
Failure to do so could result in serious injury.

## ECHO, INCORPORATED

400 Oakwood Road, Lake Zurich, Illinois 60047-1564  
Phone : 847-540-8400

X7503954103

Printed in USA

# INTRODUCTION

The ECHO model CSG-7410 Engine Cut-off saw is a high-performance gasoline-powered tool designed for use with a recommended 350 x 4.7 x 20 mm (14 in. x 6/32 in. x 25/32 in.) abrasive wheel. A water-flush attachment is available for dust control. Use only ECHO's wheels or other wheels having a minimum spindle speed rating of 3820 rpm or higher.

This manual provides the information necessary for assembly, operation and maintenance of the cut-off saw as well as the wheels available for it. It is important that you follow this information carefully.

**WARNING**

**Some dust created by power sanding, sawing, grinding, drilling, and other construction activities contains chemicals known to the State of California to cause cancer, birth defects or other reproductive harm. Some examples of these chemicals are:**

- Lead from lead-based paints,
- Crystalline silica from bricks and cement and other masonry products, and
- Arsenic and chromium from chemically treated lumber.

**Your risk from these exposures varies, depending on how often you do this type of work. To reduce your exposure to these chemicals: work in a well ventilated area, and work with approved safety equipment, such as those dust masks that are specially designed to filter out microscopic particles.**

**WARNING**

**Improper use or care of this unit, or failure to wear proper protection can result in serious injury.**

**Read the rules for safe operation and instructions in this manual.**

**Wear eye and hearing protection and a dust mask when operating.**

**Breathing in asbestos fibers can pose a serious health risk and may cause severe or fatal respiratory diseases such as lung cancer. Do not use your engine cut-off saw to cut, damage, or disturb asbestos or products using asbestos in any form. If you believe you might be cutting asbestos, contact your employer immediately.**

# CONTENTS

Introduction.....	2	Emission Data .....	20
Symbols and Signs.....	3	Operation.....	20
Packing List .....	5	Cutting Instruction .....	23
Nomenclature of Parts.....	6	Maintenance and Care .....	24
Operator Safety Precautions .....	8	Troubleshooting .....	31
Operator Safety .....	10	Storage After Use .....	32
Abrasive Wheel Types and Uses .....	12	Technical Data .....	34
Preparation for Use .....	15	Warranty Registration Sheet.....	34
Fuel and Lubricant.....	18	Notes .....	35

Specifications, descriptions and illustrations in this manual were accurate at the time of publication, and are subject to change without notice. Illustrations may include optional equipment and accessories, and may not include all standard equipment.

# SYMBOLS AND SIGNS

**⚠ DANGER**  
 The safety alert symbol accompanied by the word “DANGER” calls attention to an act or condition which WILL lead to serious personal injury or death if not avoided.

**⚠ WARNING**  
 The safety alert symbol accompanied by the word “WARNING” calls attention to an act or condition which CAN lead to serious personal injury or death if not avoided.

**⚠ CAUTION**  
 The safety alert symbol accompanied by the word “CAUTION” calls attention to an act or condition which may lead to minor or moderate personal injury if not avoided.

**⊘ CIRCLE AND SLASH SYMBOL**  
 This symbol means the specific action shown is prohibited. Ignoring these prohibitions can result in serious or fatal injury.

**NOTE**  
 This enclosed message provides tips for use, care and maintenance of the unit.

**IMPORTANT**  
 The enclosed message provides information necessary for the protection of the unit.

## Decals

**⚠ WARNING**  
 Operation of this equipment may create sparks that can start fires around dry vegetation. This unit is equipped with a spark arrestor to prevent discharge of hot particles from the engine. Contact local fire authorities for laws or regulations regarding fire prevention requirements.

**⚠ ADVERTENCIA**  
 El funcionamiento de este equipo puede generar chispas que pueden provocar incendios alrededor de vegetación seca. Esta unidad está equipada con un amortiguador de chispas para prevenir la descarga de partículas calientes del motor. Comuníquese con el departamento de bomberos de la localidad para que le expliquen las leyes o reglamentos sobre los requisitos para la prevención de incendios.

**⚠ AVERTISSEMENT**  
 L'utilisation de cet équipement peut générer des étincelles qui pourraient mettre le feu à la végétation sèche. Cette unité est équipée d'un pare-étincelles pour empêcher la diffusion de particules chaudes depuis le moteur. Contacter les autorités locales de protection contre les incendies pour connaître les lois ou réglementations sur les exigences de prévention des incendies.

**⚠ WARNING!** Read and follow all safety precautions in the operator's manual. Failure to follow these instructions could result in serious or fatal injury to the operator and/or bystanders.

**¡ADVERTENCIA!** Lea y siga todas las advertencias e instrucciones de seguridad en el manual del operador. El incumplimiento de estas instrucciones puede ocasionar lesiones graves o fatales al operador y / o a las personas presentes.

**Mise en garde!** Lire et suivre avec précaution les consignes de sécurité incluses dans ce manuel de l'utilisateur. Ne pas suivre les consignes de sécurité de ce manuel pourrait entraîner des blessures graves ou fatales pour l'utilisateur ou les toutes personnes à proximité.

Max. 350mm (14in)  
 20mm (0.787in)  
 Max. 4.7mm (0.185in)

**(max)**  
 3820 rpm





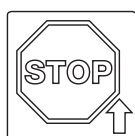







**50:1**  
**MIX** 



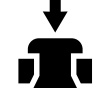

Locate the safety decals on your unit. The complete unit illustration found in the “NOMENCLATURE OF PARTS” section will help you locate them. Make sure the decal is legible and that you understand and follow the instructions on it. If a decal cannot be read, a new one can be ordered from your ECHO dealer.

## SYMBOL FORM

Symbol form/shape	Symbol description/application	Symbol form/shape	Symbol description/application
	<b>WARNING!!</b> Read and follow all safety precaution in the Operator's Manual. Failure to follow instructions could result in serious personal injury.		Choke control
	Always wear an ear muffler, a dust proof mask, goggles and a helmet when operating this machine. (ANSI Z87.1)		Oil and gasoline mixture
	Do not run the engine indoors, or where there is poor ventilation.		Wheel rotating direction Max spindle speed
	Cutting may cause sparks from the cut-off wheel. Make sure there is no flammable substance nearby.		Purge pump
	Kickback may force the cutting-off wheel up and back toward the operator with a lightning-fast reaction. Kickback can occur whenever the upper-half of the cutting-off wheel touches an object while operating the machine.		Decompression device
	Usage of saw blades not permitted.	<b>L</b>	Carburetor adjustment - Low speed mixture
	Make sure there are no breaks, cracks or warps.	<b>H</b>	Carburetor adjustment - High speed mixture
	Emergency stop	<b>T</b>	Carburetor adjustment - Idle speed
	Keep away from fire.		

# PACKING LIST

The ECHO product you purchased has been factory pre-assembled for your convenience. Due to packaging restrictions, wheel installation and other assembly may be necessary.

After opening the carton, check for damage. Immediately notify your retailer or ECHO dealer of damaged or missing parts. Use the packing list to check for missing parts.

**ECHO engine cut-off saw**

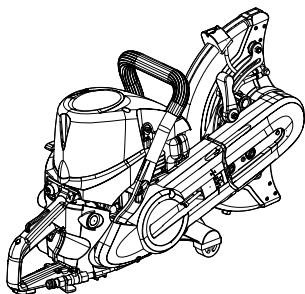

**Operator's manual**

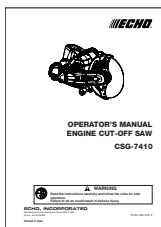

**Warranty sheet**



**13 x 19 mm T-wrench**



**Bar tool**



**Adapter (25.4 mm)**



**Coupler**

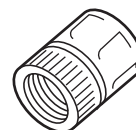

**Wheel**

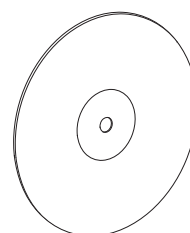

# NOMENCLATURE OF PARTS

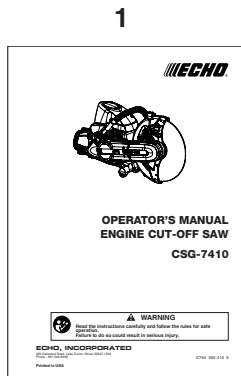
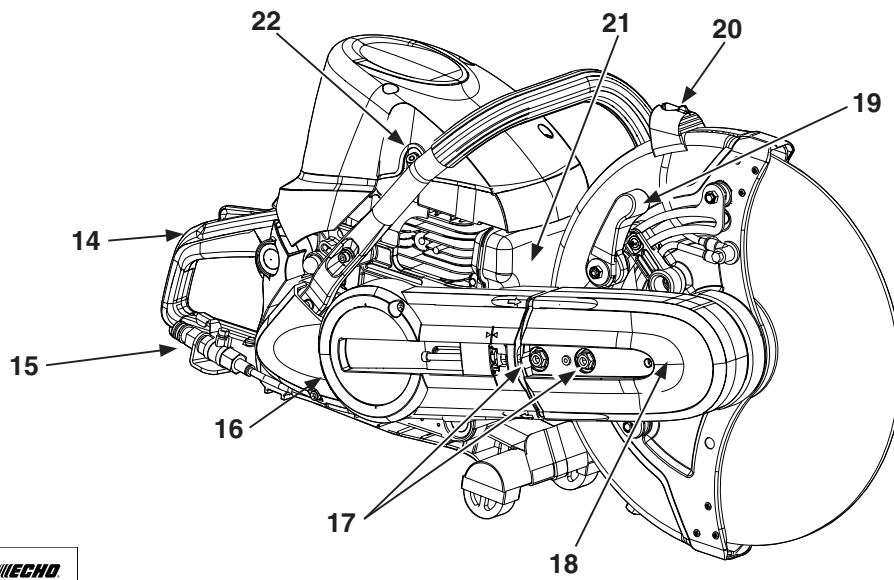
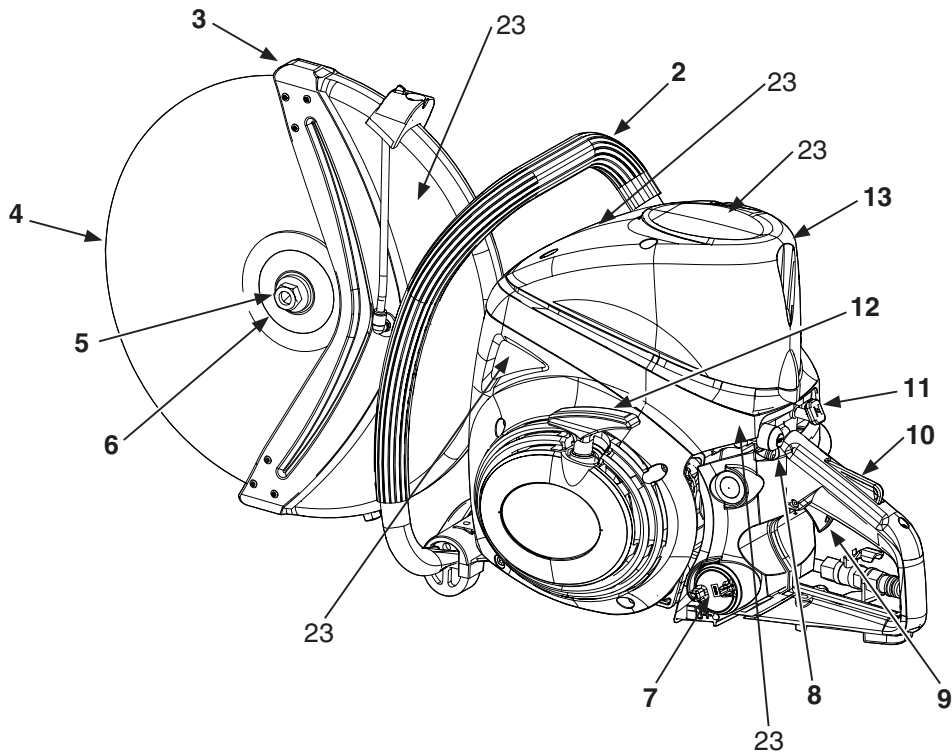

# NOMENCLATURE OF PARTS

- 1. Operator's manual** - Included with unit.  
Read before operation and keep for future reference to learn proper, safe operating techniques.
- 2. Front handle (for the left hand)** - Support handle located at the front of the engine housing.
- 3. Wheel guard** - A wheel guard which is intended to protect the operator from wheel contact, and also direct debris away from the operator.
- 4. Wheel** - Serving as a cutting tool.
- 5. Wheel mouting bolt** - Bolt that secures the flange.
- 6. Cutter flange** - Part that secures the cutting wheel.
- 7. Fuel tank cap** - For closing the fuel tank.
- 8. Momentary stop switch** - Button for momentarily shorting ignition voltage, causing the engine to stop. This is NOT an ON/OFF Ignition switch.
- 9. Throttle trigger** - Device activated by the operator's finger, for controlling the engine speed.
- 10. Throttle trigger lockout** - A safety lever which must be depressed before the throttle trigger can be activated in order to prevent the accidental operation of the throttle trigger.
- 11. Choke control knob** - Device for enriching the fuel/air mixture in the carburetor to aid cold starting. Also activates fast idle throttle latch.
- 12. Starter grip** - Pull handle slowly until starter engages then quickly and firmly.  
When engine starts, return handle slowly.  
Do not let handle snap back or damage to unit will occur.
- 13. Air cleaner cover** - Covers air cleaner.
- 14. Rear handle (for the right hand)** - Support handle located towards the rear of the engine housing.
- 15. Water kit** - Supplies water while cutting to keep dust from scattering.
- 16. Clutch cover** - Protective belt and clutch when the engine cut-off saw is in use.
- 17. Arm mounting bolts** - Secures the cut-off saw.
- 18. Pulley Cover** - Protects the belt and pulley.
- 19. Wheel guard locking knob** - For use when changing the angle of the wheel guard.
- 20. Wheel guard knob** - Grip and move this knob when changing the angle of the wheel guard.
- 21. Spark arrestor muffler** - The spark arrestor muffler controls the exhaust noise and prevents hot, glowing particles of carbon from leaving the muffler.
- 22. Decompression device** - Device for lowering the compression in the cylinder, to aid starting.
- 23. Safety labels** - Device for lowering the compression in the cylinder, to aid starting.

# OPERATOR SAFETY PRECAUTIONS

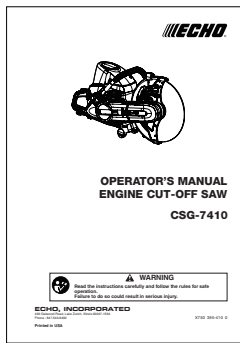

Read this engine cut-off saw operator's manual carefully. Be sure you understand how to operate this saw properly before you use it.

Establish a training program for engine cut-off saw operators.

Use safety footwear, snug-fitting clothing and protective gloves.

Wear eye, hearing and head protection devices. Use ballistics chaps or pants when necessary. Clothing of fire-resistant and non-meltable material should be worn by emergency crews exposed to flames or high heat conditions.

Use caution when handling fuel. Put the fuel tank caps back tightly on both the fuel container and the saw tank, move at least 3 m (10 ft.) from the fueling point, and be sure there is no leakage of fuel from the fuel tank cap or the fuel system before starting the engine. Avoid ignition from sparks.

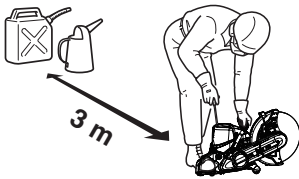

## DANGER

**After refuelling, tighten fuel cap firmly and check for leakage. In case of fuel leakage repair before starting operation since there is a danger of fire.**

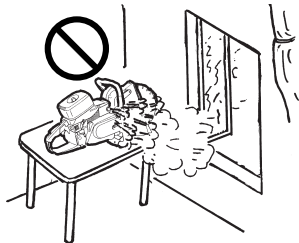

## WARNING

**Do not run the engine indoors, or where there is poor ventilation. Engine fumes contain deadly poisonous carbon monoxide.**

## IMPORTANT

- Check before every use.
- After refuelling, make sure fuel does not leak from around fuel pipe, fuel grommet or fuel tank cap.
- In case of fuel leakage there is a danger of fire. Stop using the machine immediately and request your dealer to inspect or replace.
- It is not permitted to fill fuel above the shoulder level of fuel tank.

Operate this gasoline engine cut-off saw only in well-ventilated areas.

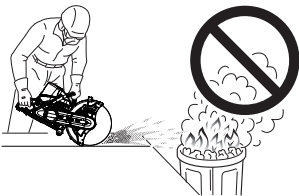

Do not store the unit with fuel in its tank, because a fuel leak could start a fire.

Do not cause sparks in any area where there are flammable materials.

Start the engine cut-off saw on the ground with the cutting wheel completely in the clear.

Do not drop-start the engine cut-off saw, or start it if the wheel is obstructed by the ground or any other object.

Do not allow other persons to be closer than 9 m (30 ft.) when you are starting or cutting with the saw. Bystanders should wear hearing and eye protection. Do not start cutting unless you have good footing and the work area is clear.

Do not let someone hold the work you are cutting.

Adjust Wheel guard

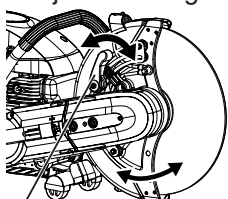

Wheel guard locking knob

Adjust the wheel guard to a position where the sparks and debris from the wheel will be thrown away from you. Turn the wheel guard locking knob counterclockwise, grasp the wheel guard knob and move the wheel guard to the desired position, slowly release it and secure the wheel guard with the locking knob. Do not operate if the wheel guard is damaged, missing from the unit, improperly positioned, or cannot be locked in proper position.



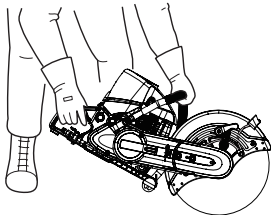

Keep a firm grip on the engine cut-off saw with both hands, the right hand on the rear handle, and the left hand on the front handle when the engine is running. Use a firm grip with thumbs and fingers encircling the saw handles. A firm grip will help you to keep control if the saw kickback toward you, or the thrust of the rotating wheel pulls it away from you. Never operate the engine cut-off saw with only one hand.

Be careful around electrical cables, sewer and gas lines to avoid cutting them.

#### Keep to Left of Cutting Line

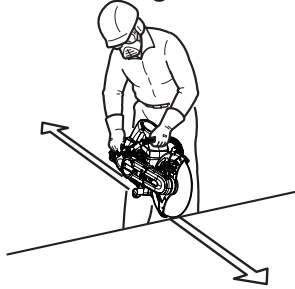

Keep to the left of the saw so that no part of your body is in line with the cutting wheel. Keep all parts of your body away from the cutting wheel when the engine is running.

Do all cutting at full throttle. Cutting at less than full speed can damage the clutch by allowing it to slip. Accelerating from slow to full speed while the wheel is in cutting contact may cause a violent push or pull reaction resulting in loss of control.

It will take time for the wheel to coast to a stop after the throttle trigger is released. Be sure to wait for rotation to stop before releasing your grip on the saw handles. Always shut off the engine before setting down the saw.

Never leave the engine cut-off saw while the engine is running.

Always carry the saw with the engine stopped and the hot muffler away from your body. Do not touch a hot muffler, wheel, cylinder cover or cylinder.

Do not touch high voltage parts such as spark plug and spark plug lead.

Remove the wheel from the saw prior to transport or storage. Store wheels properly to avoid damage from uneven pressure, moisture and extreme temperatures.

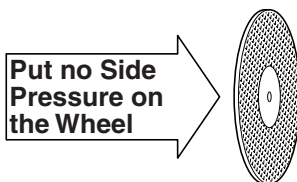

Do not grind on the side of an abrasive engine cut-off saw wheel, or put any side pressure on the wheel during cutting. Avoid letting the saw tilt or wobble off line.

Use new, properly qualified wheels of correct diameter, thickness and mounting hole size. The wheel blotters and the mounting flanges should be in good condition, and the mounting bolt should be tightened to the proper torque.

#### Check for Wheel Damage

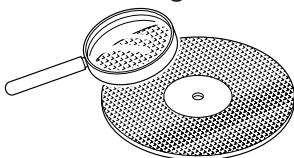

Inspect the wheel carefully for cracks, edge damage and warping before use. Do not use any wheel that has been dropped.

All adjustment and maintenance instructions in this operator's manual should be performed as necessary, and may be done by the saw owner. All other service or adjustment should be performed only by a qualified ECHO servicing dealer.

# OPERATOR SAFETY

## Protective Equipment



### WARNING

Engine cut-off saw users risk injury if the saw is used improperly, and / or safety precautions are not followed. Protective clothing and safety gear must be worn when operating a engine cut-off saw.



- You must wear eye protection goggles qualified to the CE mark or the latest ANSI Standard Z 87. (Z 87 is stamped on the goggles). These goggles also must be worn under a face screen if one is used. A face screen should be worn when there is a risk from flying debris.
- Hearing protection should be worn. (See “DANGER,” page 23)
- Wear a respirator or dust mask (APF10) when cutting concrete, stone, brick or other materials where fine dust is produced while cutting. Use water flush to keep down the dust.
- Clothing should be made from fabric containing natural fibres that resist catching fire and do not melt. The clothing should cover as much skin area as possible. Clothing should offer freedom of movement, but should not be too loose or baggy. Do not wear ties or jewellery.
- Wear heavy duty boots with non-slip soles. The boots should be high enough for shin protection, or you should wear chaps for shin protection.
- Wear non-slip, heavy duty work gloves to improve your grip on the saw handles. The gloves also help to reduce the transmission of machine vibrations to your hands.

## Protecting Others



Spectators children and fellow workers must be warned to come no nearer than 9 m (30 feet) while the saw is in use. Shut off the saw immediately if someone moves closer to you than 9 m (30 feet). Persons working in the area near you should wear the same protective equipment as the saw operator if endangered by risky flying debris.

## Physical Condition



Your judgment and / or dexterity may be impaired if you are ill or have taken alcohol or other substances known to affect the way you would function normally. Operate only when sound in mind and body.



### **WARNING**

#### **Precautions Against Vibration and Cold**

It is believed that a condition called **Raynaud's Phenomenon** which affects the fingers of certain individuals is brought about by exposure to cold and vibration. Accordingly, your ECHO Engine cut-off saw has shock mounts designed to reduce the intensity of vibration received through the saw handles. Exposure to cold and vibration may cause tingling and burning, followed by loss of colour and numbness, in a person's fingers. We strongly recommend your taking the following precautions because the minimum exposure which might trigger the ailment is unknown.

- Keep your body warm – especially head, neck, feet and ankles, and hands and wrists.
- Maintain good blood circulation by performing vigorous arm exercises during frequent work breaks, and also by not smoking.
- Limit the number of hours of engine cut-off saw operation. Try to fill a part of each work day with jobs where operating this saw or other hand-held power tools are not required.
- If you experience discomfort, redness and swelling of the fingers, followed by whitening and loss of feeling, consult your physician before exposing yourself further to cold and vibration.

# ABRASIVE WHEEL TYPES AND USES

## ECHO Reinforced Wheels

ECHO Wheels are labelled for the type of materials they are designed to cut. The types of wheels identified below, and other types, may be available from ECHO dealer.

**⚠ WARNING**

- This saw includes an abrasive wheel and a water system.
- Do not use water with an abrasive wheel.

Labeled Application	Primary Use	Other Uses	Dry or Water Flush
Metal	General purpose mild and stainless steel: re-bar, pipe and structural steel	Aluminum and soft brass. Does not cut non-metals very well	Dry
Ductile	Ductile or cast Iron and concrete lined pipe	All except very hard metals	Dry. Does not cut well when wet
Rail Track	Heat treated, wear hardened and alloyed steel	Not for non-metals	Dry
Masonry	All masonry, concrete and stone products and asphalt	Not for metals	Dry
Diamond Wheel	Rock, block, stone, tile	Not for metal or reinforced concrete	Constant Water Flush or Dry

## Wheel Speed Rating

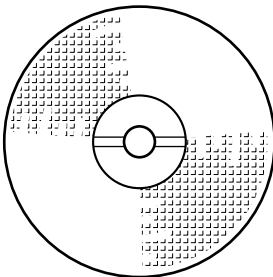

**Read Label on The Wheel**

This is the minimum acceptable wheel speed rating for this unit. Wheels rated less than 3820 rpm must not be used on this engine cut-off saw.

## Maximum Allowable Wheel Speed

The wheel rotates at the same speed as the spindle (arbour) on which it is mounted. The wheel must never be allowed to rotate faster than 3820 rpm if the wheel speed is rated at 3820 rpm.

## Wheel Blotters and Mounting Flanges

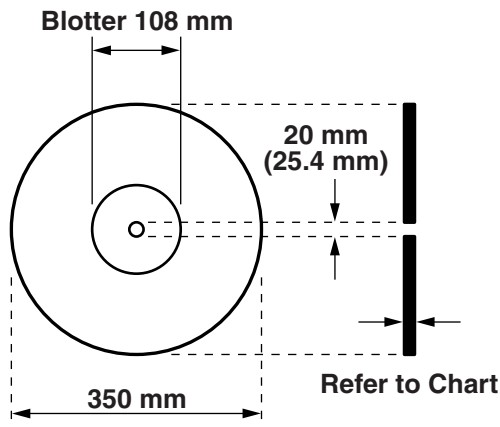

Wheel blotters attached to both sides of reinforced wheels are cushions needed to equalize the pressure of the mounting flanges from wear if slippage between the wheel and the flanges occurs. The blotters are 108 mm (4 1/4 in.) diameter. Take care that the blotters do not become gouged or deeply scratched and that there is no foreign material on them when mounting the wheel.

Wheel Dimensions			
	Wheel Diameter	Mounting Hole Diameter	Thickness
Abrasive Wheel:	350 mm (13.8 in.)	20 mm (25.4 mm with Adapter)	Max. 4.7 mm (6/32 in.)
Diamond Wheel:	350 mm (13.8 in.)	20 mm (25.4 mm with Adapter)	Max. 4.7 mm (6/32 in.)

## Emergency Applications

### ⚠ WARNING

- Do not grind with a cut-off wheel or put pressure on the sides.
- Do not mount wheel if blotters are damaged. Do not destroy cushioning effect by making mounting bolts too tight. Never fasten while applying your weight. Otherwise the thread could be broken. Proper torque is 25 N•m (250 kgf•cm) - 30 N•m (300 kgf•cm).
- Examine wheel carefully before use. Do not use if wheel is warped, damp, cracked, chipped or cutting area shows heat discoloration.
- Dropping a wheel can easily damage it. Discard a wheel if you drop it.

## Ring Testing Wheels

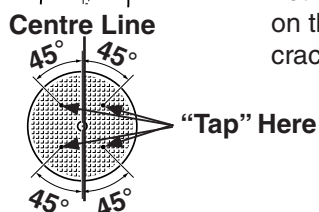
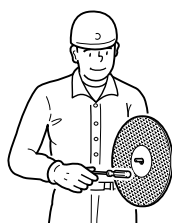

Cracks or defects in a wheel may not be visible. To help in verifying that a wheel is OK to use, a “ring test”. Perform the ring test immediately before mounting all new or used wheels.

Put your finger through the mounting hole to support the wheel. Use a non-metallic handle of any small tool or a small piece of wood to lightly tap (do not hit) the wheel in the locations shown in the illustration. Do not tap wheel on the edge. Wheels without cracks will make a ringing sound, wheels with cracks, or concealed cracks, will make a dull “clunk”.

### IMPORTANT

If a wheel being “ring tested” is dirty or damp or is tapped at the vertical centre line, the resulting sound will be muffled and not reliable.

## Facts About Abrasive Wheel

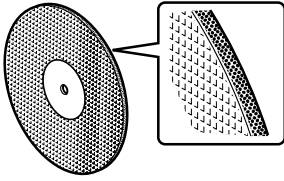

ECHO wheels are made by laying a strong fibre mesh material into a form, pouring a mixture of resin and the abrasive grit particles over the mesh, and adding a second layer of mesh over the mixture. Then the resin and reinforcing mesh are bonded together and cured.

The wheel's ability to cut certain materials are due to the type abrasive, size of the grit and it's spacing. The reinforcement on both sides adds strength and rigidity.

Always read the label on the wheel. If the wheel does not cut well, it may be the wrong type for the material. Forcing it to cut may result in shattering of the wheel and serious injury to the operator.

### **WARNING**

**Do not use water with an abrasive wheel.**

**Do not grind with a cut-off wheel or put pressure on the sides.**

**Wheels that are too thick or fit the arbour improperly may shatter, causing serious personal injury. So may wheels of low speed rating or those that are cracked, warped, out-of-round or edge-damaged.**

**Put no Side Pressure on the Wheel**

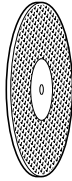

A wheel can stand a lot of cutting pressure as long as the pressure is straight on and not from the side of the wheel. This is why you always must make only straight line cuts.

Saws intended for forcible entry should be equipped with new wheels for each use. If the used wheels can pass the ring test (page 13) and close inspection, they may be use in training emergency crews.

## Handling and Storage of Wheels

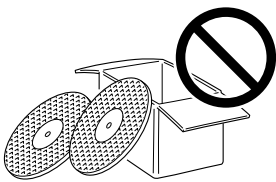

Check every wheel for warping, cracks and broken edges before mounting on the saw.

Warped wheels do not cut properly and may be stressed to the point of breaking. Always store your wheels laying flat, on a dry surface. When stacking many wheels, place cardboard or paper spacers between them as a cushion.



Moisture and heat both can cause wheel damage. Do not let wheels lie in the sun or expose them to high heat. Keep wheels dry at all times, and store in an area of low humidity and moderate temperature. Protection from moisture damage applies during water-flush cutting.

# PREPARATION FOR USE

## How to Install the Wheel

### Replacing the Adapter

Install the adapter that fits the inside diameter of the cutting wheel. When shipped, an adapter with an outside diameter of 20 mm is mounted. If the inside diameter of the cutting wheel to be used is 25.4 mm, replace the adapter as follows.

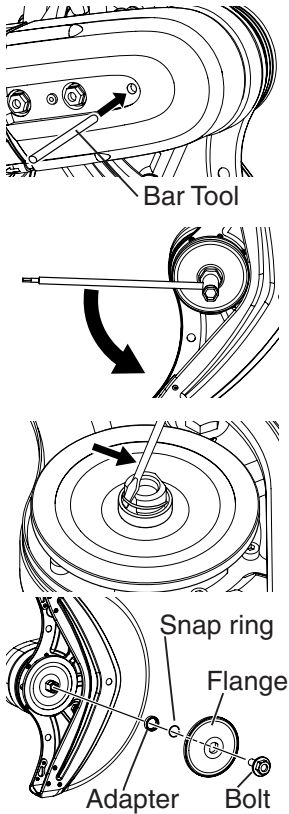

1. Insert the bar tool.

2. Rotate the drive shaft until the hole in the large pulley and the bar tool aligned.

3. Unscrew wheel mounting bolt with the 19 mm end of the box wrench or your fingers.

Remove wheel bolt and outer flange, leaving inner flange in place.

4. The adapter is held to the drive shaft with a snap ring. Insert a tool like a small slotted screwdriver in the gap and remove the snap ring.

5. Replace with an adapter that fits the inside diameter of the cutting wheel to be used.

6. Press the snap ring in until it reaches the groove in the drive shaft and secures the adapter. If the snap ring is deformed, replace it with a new one.

### Installing a Cutting Wheel

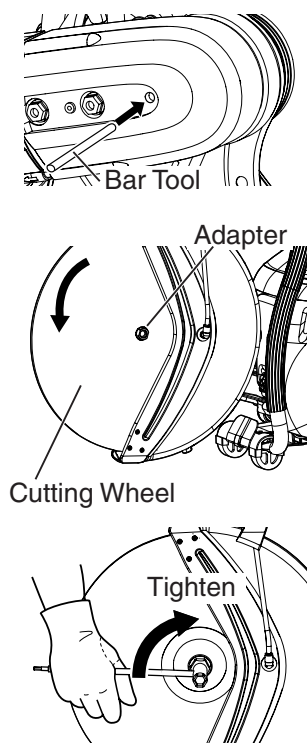

1. Insert the bar tool.

Rotate the drive shaft until the hole in the large pulley and the bar tool aligned.

2. Unscrew wheel mounting bolt with the 19 mm end of the box wrench or your fingers.

3. Remove wheel bolt and outer flange, leaving inner flange in place.

4. Confirm the direction of rotation of the cutting wheel and mount it so its centre hole fits over the adapter mounted on the drive shaft.

5. Align the hole in the cutter flange with the drive shaft and press it on.

6. Finger tighten the wheel bolt and then tighten it fully with a socket wrench. Tighten it to a torque of 25 to 30 N·m.

7. Remove the bar tool and rotate the cutting wheel by hand; make sure it is straight and wobble-free.

### WARNING

- Before tightening, check that flanges are properly seated and not cocked on the mount or bolt threads. Do not make bolt so tight as to destroy the cushion supplied by the wheel blotters. Do not use pneumatic, electric-powered tools or one's body weight for tightening. Otherwise the thread could be broken. Do not tighten more than 30 N•m (300 kgf•cm).

### NOTE

Arm may be removed and remounted with wheel on the outboard side of the arm as required for certain procedures.

## Adjusting the Wheel Guard Angle

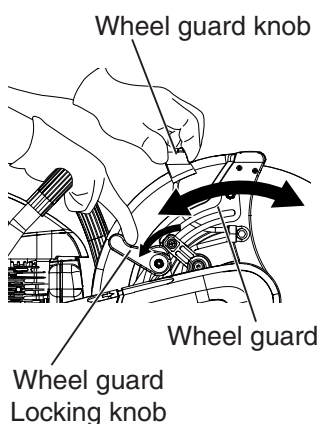

### WARNING

- Never operate the machine without the wheel guard in place.

1. The wheel guard can be adjusted to prevent debris from flying off and hitting the operator.
2. Turn the wheel guard locking knob counterclockwise, grasp the wheel guard knob and move the wheel guard to the desired position, then slowly release it and secure the wheel guard with the locking knob.

\* Never operate the machine without the guard stopper in place.

## Reverse Mounting the Cutter Arm

When shipped the cutting wheel is mounted so it is near the center of gravity of the machine. The cutting wheel can be moved to a position outside the machine by reverse mounting the cutter arm.

### WARNING

- Reverse mounting the cutter arm compromises the balance of the machine and makes it difficult to operate. Do not use it in the reversed state except when necessary.

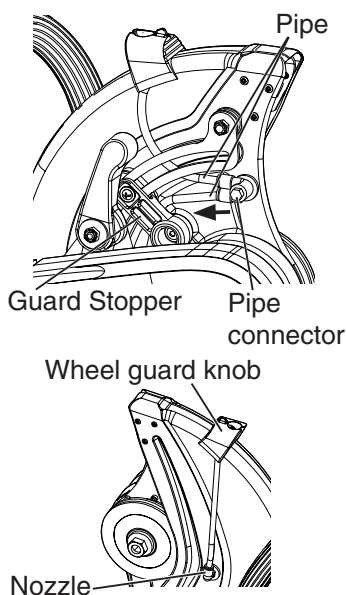

1. Remove the cutting wheel.
2. Remove the 2 screws and remove the guard stopper.
3. Remove both of the pipes connected to the pipe connector. Remove the pipe connector after removing the nut mounted on the wheel guard.
4. Mount the pipe connector in the lower hole in the wheel guard.
5. Loosen the nut that holds the nozzle in place.
6. Remove the wheel guard knob mounted on the wheel cover.



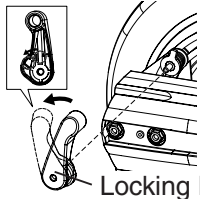

Locking Knob

7. Loosen the nut of the locking knob and reinstall it after changing the angle of the knob.

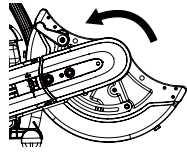

Pulley cover

8. Change the angle of the wheel guard.

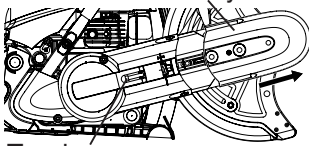

Tension screw

9. Loosen the tension screw until its tip cannot be seen, then remove the 2 pulley cover bolts.

10. Remove the pulley cover.

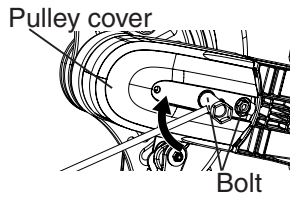
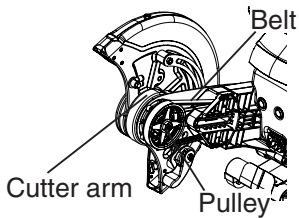

11. Remove the cutter arm from the crankcase. Remove the belt at the same time.

12. Reverse the cutter arm and mount it in the long hole in the crankcase.

13. Put the belt on the pulley.

14. Put the pulley cover into the cutter arm. Make sure the pulley cover is not misaligned when putting it into the arm.

15. Finger tighten the 2 pulley cover bolts, then back them off about 1 turn. Adjust the tightness of the belt.

16. Tighten the 2 pulley cover bolts. Note: Tighten it to a torque of 23 to 27N·m (230 to 270 kgf·cm).

17. Change the nozzle angle and then tighten the nut.

18. Insert the 2 pipes into the pipe connector.

19. Mount the knob on the top of the wheel guard.

20. Install the guard stopper on the guard (above the cutting arm).

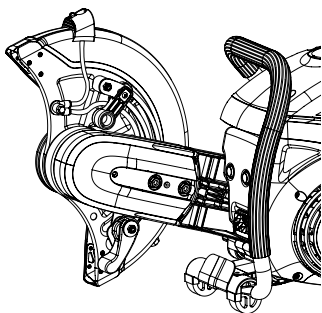

# FUEL AND LUBRICANT

## FUEL

### WARNING

Diesel fuels and alternative fuels, such as E-15 (15% ethanol), E -85 (85% ethanol) or any fuels not meeting ECHO requirements are NOT approved for use in ECHO 2-stroke gasoline engines. Use of diesel or alternative fuels may cause performance problems, loss of power, overheating, fuel vapor lock, and unintended machine operation, including, but not limited to, improper clutch engagement. Diesel or alternative fuels may also cause premature deterioration of fuel lines, gaskets, carburetors and other engine components.

### Fuel Requirements

**Gasoline** - Use 89 Octane [R+M/2] (mid grade or higher) gasoline known to be good quality. Gasoline may contain up to 10% Ethanol (grain alcohol) or 15% MTBE (methyl tertiary-butyl ether). Gasoline containing methanol (wood alcohol) is NOT approved. Use of ECHO brand fuel is recommended to extend engine life in all air-cooled 2-stroke and 2/4-stroke hybrid engines.

**Two Stroke Oil** - A two-stroke engine oil meeting ISO-L-EGD (ISO/CD 13738) and J.A.S.O. FD Standards must be used. ECHO brand 2-stroke oils meet these standards. Engine problems due to inadequate lubrication caused by failure to use an ISO-L-EGD (ISO/CD 13738) and J.A.S.O. M345-FD certified oil, such as ECHO brand 2-stroke oils, will void the two-stroke engine warranty.

### WARNING

2-Stroke engine oil contains petroleum distillates and other additives that may be harmful if swallowed. Heated oil can release vapors that can cause flash fire, or ignite with explosive force. Read and follow the oil manufacturer's instructions, and observe all safety warnings and precautions for handling flammable liquids. For more detailed safety and first aid information, visit [www.echo-usa.com](http://www.echo-usa.com) for a copy of the Material Safety Data Sheet.

- KEEP OUT OF REACH OF CHILDREN.
- If swallowed, do not induce vomiting. CALL PHYSICIAN OR A POISON CONTROL CENTER IMMEDIATELY.
- WEAR SAFETY GLASSES when mixing or handling.
- AVOID repeated or prolonged skin contact
- AVOID inhaling oil mists or vapors.

### NOTICE

ECHO brand 2-stroke oils may be mixed at 50:1 ratio for application in all ECHO engines sold in the past regardless of ratio specified in those manuals.

### Handling Fuel

### DANGER

Fuel is VERY flammable. Use extreme care when mixing, storing or handling, or serious personal injury may result.

Use an approved fuel container. Mark fuel containers as containing 2-stroke mixture fuel.

- DO NOT smoke near fuel.
- DO NOT allow flames or sparks near fuel.
- Fuel tanks/cans may be under pressure. Always loosen fuel caps slowly allowing pressure to equalize.
- NEVER refuel a unit when the engine is HOT or RUNNING!
- DO NOT fill fuel tanks indoors. ALWAYS fill fuel tanks outdoors over bare ground.
- DO NOT overfill fuel tank. Wipe up spills immediately.
- Securely tighten fuel tank cap and close fuel container after refueling.
- Inspect for fuel leakage. If fuel leakage is found, do not start or operate unit until leakage is repaired.
- Move at least 3 m (10 ft.) from refueling location before starting the engine.

### DANGER

Gasoline vapor is heavier than air, and can travel along the ground to nearby sources of ignition such as electrical motors, pilot lights, and hot or running engines. Vapors ignited by an ignition source can flash back to the fuel container, resulting in an explosion, fire, serious or fatal injuries, and extensive property damage.

## Mixing Instructions

1. Fill an approved fuel container with half of the required amount of gasoline.
2. Add the proper amount of 2-stroke oil to gasoline.
3. Close container and shake to mix oil with gasoline.
4. Add remaining gasoline, close fuel container, and remix.

Fuel to Oil Mix – 50:1 Ratio			
US		Metric	
Gas	Oil	Gas	Oil
gal.	fl.oz.	L	cc
1	2.6	5	100
2	5.2	10	200
5	13	25	500

### NOTICE

**Stored fuel ages. Do not mix more fuel than you expect to use in 30 days, 90 days when a fuel stabilizer is added.**

**Stored two-stroke fuel may separate. ALWAYS shake fuel container thoroughly before each use.**

**Used oil and gasoline, and soiled towels are hazardous waste materials. Disposal laws vary by locality.**



## EMISSION DATA

### EMISSION CONTROL

(EXHAUST and EVAPORATIVE)

#### EPA 2010 and Later and/or C.A.R.B. TIER III

The emission control system for the engine is EM (engine modification) and, if the second to last character of the Engine Family on the Emission Control Information label (sample below) is "C", "K", or "T", the emission control system is EM and TWC (3-way catalyst). The fuel tank/fuel line emission control system is EVAP (evaporative emissions). Evaporative emissions for California models may only be applicable to fuel tanks and fuel feed lines.

**An Emission Control Label** is located on the engine ( example only, information on label varies by engine family).

### PRODUCT EMISSION DURABILITY (EMISSION COMPLIANCE PERIOD)

The 300 hours emission compliance period is the time span selected by the manufacturer certifying the engine emissions output meets applicable emissions regulations, provided that approved maintenance procedures are followed as listed in the Maintenance Section of this manual.

#### EMISSION CONTROL INFORMATION

ENGINE FAMILY: #EHXS.0735RA DISPLACEMENT: 73.5 cc  
EMISSION COMPLIANCE PERIOD: 300 Hours  
THIS ENGINE MEETS U.S. EPA EXH/EVP EMISSION REGULATIONS FOR MODEL YEAR \*\*\*\* REFER TO OWNER'S MANUAL FOR MAINTENANCE SPECIFICATIONS AND ADJUSTMENTS.  
YAMABIKO CORP. \*\*\*XXXX

# OPERATION

## Safe Starting Techniques

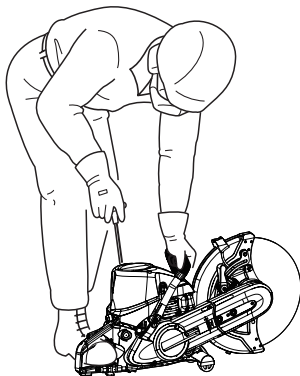

Set saw down on level ground with wheel in the clear. Grasp front handle with left hand, and hold down rear handle with toe of your boot. Never “drop-start” the saw.



### WARNING

Wheel will rotate when engine is started at fast idle throttle latch setting. Keep cutting wheel in the clear.

### IMPORTANT

- Check unit for loose nuts, bolts and screws before starting.
- Make sure the wheel guard is securely in place.
- Always clear work area of debris before starting operation.
- Always hold the unit firmly.
- When pulling starting rope, use short pulls, 1/2 to 2/3 of rope length.
- Do not allow the starter grip to snap back against the housing.

## WHEN THE ENGINE IS COLD

Decompression device

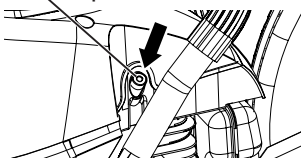

1. Fill the fuel tank with fuel mixture. It is not permitted to fill fuel above the shoulder level of fuel tank.
2. Press the decompression device.

Primer pump

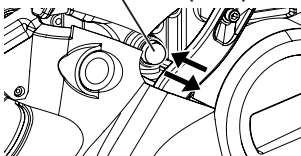

3. Push primer pump until fuel is visible in primer pump.

Choke

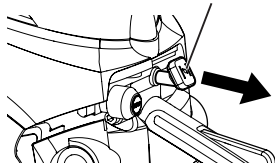

4. Pull out choke all the way (engages the fast idle throttle latch setting).

Starter grip

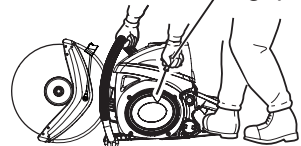

5. Securely hold the engine cut-off saw. Pull starter grip briskly, but only 1/2 to 2/3 its full length. Pulling rope to the end may damage the starter.
6. Push in the choke the first time engine fires, and crank until engine starts and runs. In cold weather you should keep the choke out just a little until the engine gets very warm. But, do not operate with the choke out.

Throttle trigger lockout

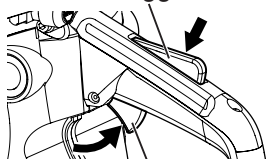

Throttle trigger

7. Squeeze and release trigger when engine runs to release the fast idle throttle latch setting. You now have trigger control of the throttle speed.

## WHEN THE ENGINE IS WARM

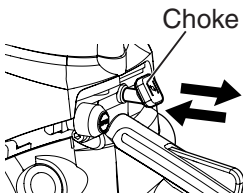
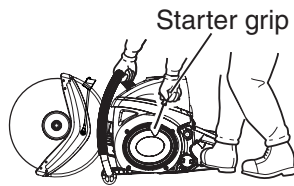

1. Fill the fuel tank with fuel mixture. It is not permitted to fill fuel above the shoulder level of fuel tank.
2. Press the decompression device.
3. Securely hold the engine cut-off saw. Pull starter grip briskly, but only 1/2 to 2/3 its full length. Pulling rope to the end may damage the starter.

- \* If the engine is hard to start, pull the choke to engage the fast idle throttle latch setting, then return the choke to its normal position (this opens the throttle slightly).  
If it still fails to start, revert to the WHEN ENGINE IS COLD starting procedure.

## RUNNING

1. Once the engine starts, allow it to warm up for 2 to 3 minutes at idling (i.e. low speed).
2. Warming the engine helps to lubricate its internal workings more smoothly. Allow the engine to warm up fully, especially when it is cold.

## Stopping Engine

Momentary stop switch

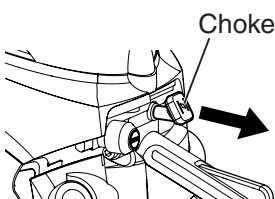
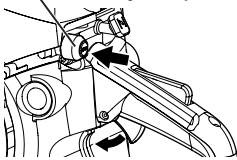

### **WARNING**

**Momentary stop switch automatically returns to run position. Engine can start unintentionally when starter handle is pulled. Always remove spark plug lead from spark plug before pulling starter handle, otherwise severe personal injury may result.**

Release throttle trigger and allow engine to idle.

Push the momentary stop switch.

The engine stops with just one press of the stop switch. It is not necessary to hold the switch until it stops.

If engine does not stop, pull choke control knob out fully to stop engine. The choked engine will slow to a stop. Be sure to keep the wheel in the clear until all movement stops.

### **WARNING**

**With trigger latched, wheel will rotate as soon as engine starts. Keep wheel in the clear. Wheel will rotate for some time after the trigger is released. Keep wheel in the clear until all movement stops.**

## Dust Suppression

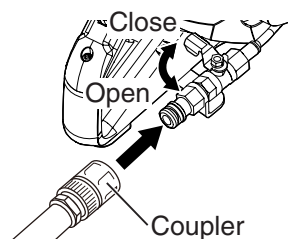

### **WARNING**

**Do not use with wheels that are not designed to be used with water-flush cutting. Doing so may damage the wheel while it is being used.**

1. Use water-flush cutting when doing work that generates a lot of dust, such as cutting concrete.
2. Attach a water hose with a coupler on it to the joint of the engine cut-off saw.
3. Make sure the liquid cock is in the closed position before turning the water faucet on.
4. Adjust the water flow with the liquid cock.
5. After cutting, turn off the water and let the wheel spin itself dry.

### **IMPORTANT**

Make sure there are no water leaks before use.  
Use as little water as possible to sufficiently suppress generation of dust.

# CUTTING INSTRUCTION

## Sequence after Starting Engine

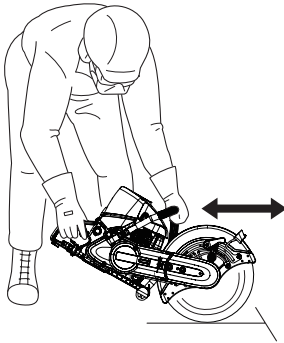

1. Squeeze and release trigger to unlatch it and take control of the throttle.
2. Let engine warm to operating temperature before doing any cutting.
3. Take cutting stance on left side of saw. Never get any part of your body behind the saw. Hold the saw firmly with both hands. Throttle up to cutting speed and make gentle wheel contact with the work.

## Cutting Asphalt, Tar and Reinforced Materials



Old, cold and hardened asphalt paving can be cut with a masonry wheel with good results and little trouble with tarring of the wheel. Fresh asphalt and tarred surfaces can gum up the wheel and slow its cutting action. Some tar or resin-impregnated materials also may present problems of this sort.

Masonry containing metal reinforcement is best cut with a masonry wheel which can cut through the reinforcing steel better than a wheel designed for metal can cut the masonry. Expect faster than normal wheel wear.

### DANGER

- Do not raise saw above chest height, because the saw is hard to control when held up high, and dust or sparks will fall on you.
- Wear hearing protection. Without it you risk hearing loss, especially where bounce-back of sound waves off nearby surfaces increases the noise.
- Do not take awkward or risky operating positions. Find solid footing for both feet, and always hold the saw firmly with both hands. Never make one-handed cuts.

## Kickback safety precautions

Rotational kickback

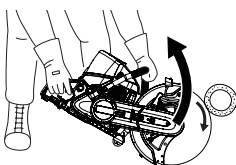

Linear kickback

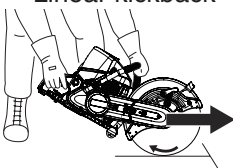

### DANGER

Kickback may force the cutting-off wheel up and back toward the operator with a lightning-fast reaction. Kickback can occur whenever the upper-half of the cutting-off wheel touches an object while operating the machine. This may cause the cutting wheel to touch the operator, resulting in serious injury

- **Rotational kickback**  
Cutting with the upper part of the cutting wheel generates kickback from the material being cut; this causes the tip of the cutting wheel to kick back from the rotation and is extremely dangerous. Always cut with the bottom of the cutting wheel.
- **Linear kickback**  
When cutting with the bottom of the cutting wheel, the machine may generate a force that pulls the machine forward. Always hold the handle firmly while working.

## Cutting Technique

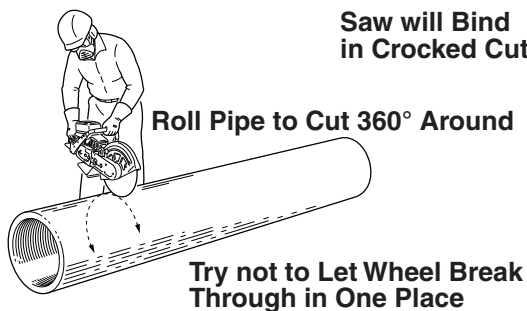
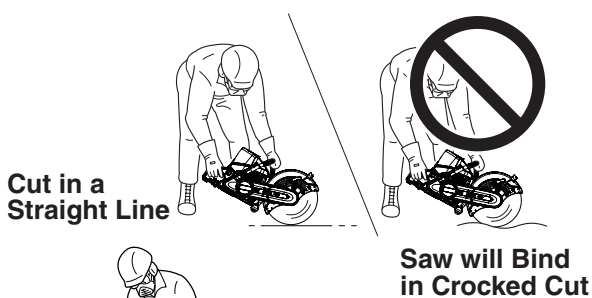
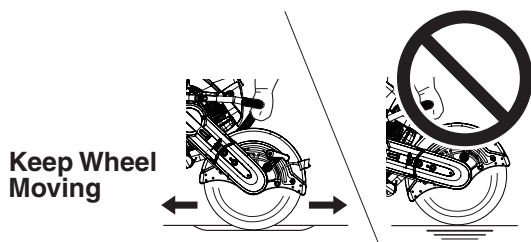
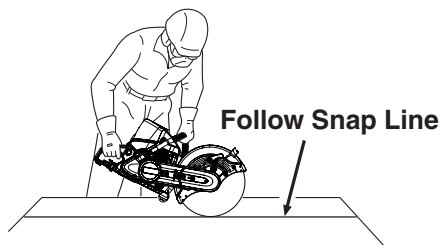
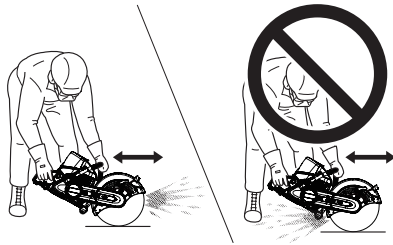

The main objectives are to avoid overheating the wheel, and to prevent it from being pinched or trapped or stressed in any way.

- Adjust position of wheel guard to direct the discharge away from you.
- Prepare to make straight cuts only. Use a snap-line to mark long cuts, and follow the marked line carefully.
- Take a balanced, comfortable stance on the left side of the saw. Hold saw firmly with both hands.
- Always throttle up to cutting speed before letting the wheel make contact. The saw may be jerked forward, causing loss of control, if wheel is in contact during throttling up. Carefully let cutting edge of wheel make light contact with the work. Do not push or bounce the wheel onto the work. Hold saw steady. Do not let it tilt or wobble.
- Do not let the wheel stop in one place, but keep it moving - in one direction, or back and forth, along the line of cut. Cutting in one spot causes heat build-up which can damage or glaze the wheel. Too much cutting pressure also causes overheating.
- Cut as shallow and straight a groove as you can. If you cut a curve, the wheel will start to bind as the cut deepens.
- Go over and over the groove you have started until the cut is completed.
- On cuts of long duration, remove saw from cut often to let the wheel cool.
- Never put any side pressure on a engine cut-off saw wheel, grind on the side of it or use it to flick away debris.
- When cutting large diameter pipe, cut 360 degrees around and try not to cut through. If a large segment of the wheel breaks through, the wheel may catch and kick out at lightning-fast speed.
- Before cutting materials which are not supported along their entire length, provide support to prevent binding. Also be aware that the top section will settle on the wheel if a column is cut in two.
- Be careful not to cut your own legs in the downward cutting. Be particularly careful at the end of cutting.

### NOTE

Always cut at full throttle. Cutting at less than full throttle may harm the clutch as it will overheat during slippage.

# MAINTENANCE AND CARE

Your ECHO engine cut-off saw is designed to provide many hours of trouble free service. Regular scheduled maintenance will help your engine cut-off saw achieve that goal. If you are unsure or are not equipped with the necessary tools, you may want to take your unit to an ECHO Service Dealer for maintenance. To help you decide whether you want to DO-IT-YOURSELF or have the ECHO Dealer do it, each maintenance task has been graded. If the task is not listed ask your ECHO dealer for repairs.

## SKILL LEVELS

**Level 1** = Easy to do. Most required tools come with unit.

**Level 2** = Moderate difficulty. Some specialized tools may be required.



### WARNING

**Momentary stop switch automatically returns to run position. Engine can start unintentionally. Always remove spark plug lead from spark plug before assembling or performing maintenance procedures or serious personal injury can result.**

## MAINTENANCE INTERVALS

Component / system	Maintenance procedure	Required Skill level	Daily or Before use	Every refuel	Every 50 hours or Yearly	Every 100 hours
Air Filter	Inspect / Replace	1			I/R *	
Fuel System	Inspect / Clean / Replace	1	I *	I *		
Fuel Filter	Inspect / Replace	1			I / R *	
Fuel Cap Gasket	Inspect / Replace	1			I *	R *
Wheel	Inspect / Replace	1	I	I		
Wheel guard	Inspect / Clean	1	I / C			
Flange	Inspect / Clean / Replace	1	I / C *			
Belt	Inspect / Tensioning / Replace	1	I			I / R *
Clutch	Inspect / Replace	2	I *			
Spark Plug	Inspect / Clean / Replace	1			I / C / R *	
Cooling System	Inspect / Clean	1	I / C			
Muffler Spark Arrestor	Inspect / Clean / Replace	2	I		I / C / R *	
Cylinder Exhaust Port	Inspect / Clean / Decarbon	2			I / C	
Recoil Starter Rope	Inspect / Clean	2	I / C *			
Screws / Nuts / Bolts	Inspect / Tighten / Replace	1	I *			

### Maintenance Procedure Letter Codes:

**I** = Inspect

**C** = Clean

**R** = Replace

### Maintenance Procedure Notes:

\* = All recommendations to replace are based on the finding of damage or wear during inspection.



### WARNING

**When replacing parts, always use ECHO genuine parts. Using non genuine parts may result in serious injury.**

### IMPORTANT

Time intervals shown are maximum. Actual use and your experience will determine the frequency of required maintenance.



## Air Filter

The air filters of this product are designed to be maintenance-free for a long period of time. However, in the following cases the main and sub air filters should be replaced.

- If engine output drops markedly
- If damage or wear is found

### IMPORTANT

Do not attempt to clean the main or sub air filters with compressed air. In an emergency, tap main filter upside down on a hard surface. Assure that filter is not torn or damaged.

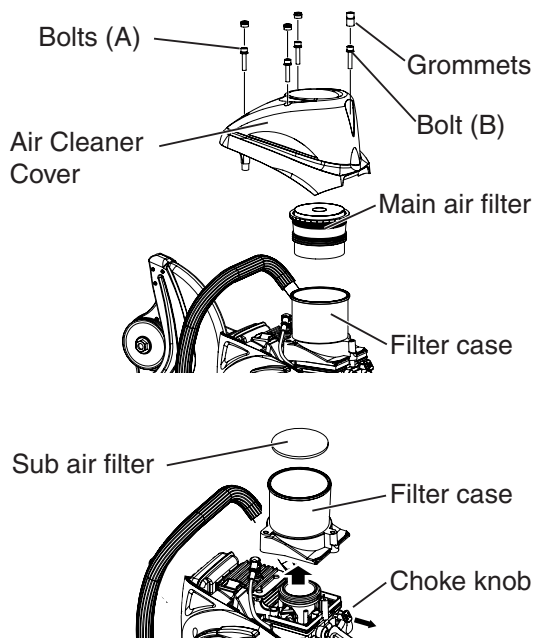

### Air Filter Replacement Procedure

1. Remove the 4 grommets on the air cleaner cover.
2. Remove the 4 bolts securing the air cleaner cover and then remove the cover.
3. Remove the main and sub air filters. The sub air filter can be removed by pulling out the choke and lifting up the filter case and then pressing on the filter from the under side.
4. Put the filter case back in position.
5. Install new sub and main air filters. Replace both filters at the same time.
6. Install the air cleaner cover and tighten its 4 bolts. Tighten the 3 bolts (A) and then the bolt (B).
7. Make sure the grommets are facing the right way when installing them on the air cleaner cover.

## Spark Plug

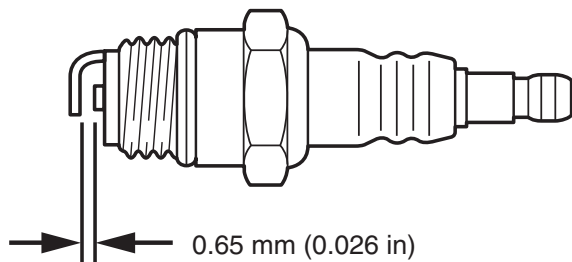
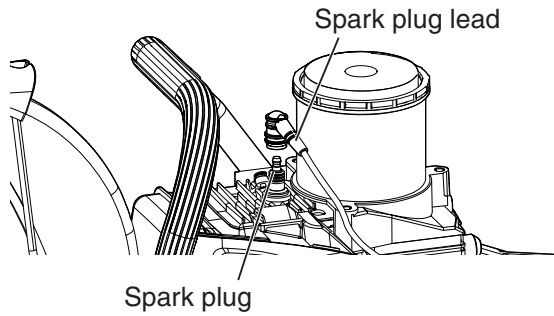

1. Remove air cleaner cover.
2. Remove spark plug lead.
3. Remove spark plug.
4. The proper spark plug for this engine is NGK BPMP7A. The firing gap between the electrodes should be adjusted to 0.65 mm (0.026 in) before use.
5. Install the spark plug. Proper tightness with a cold engine is 17 to 19 N•m (170 to 190 kgf•cm).
6. Many failed plugs can be restored by filing or scraping the electrodes down to bare metal, cleaning all deposits off the porcelain insulation around the centre electrode, then setting the gap.

### **WARNING**

**Fuel vapours are extremely flammable and may cause fire and/or explosion. Never test for ignition spark by grounding spark plug near cylinder plug hole, otherwise serious personal injury may result.**

## Replace Fuel Filter

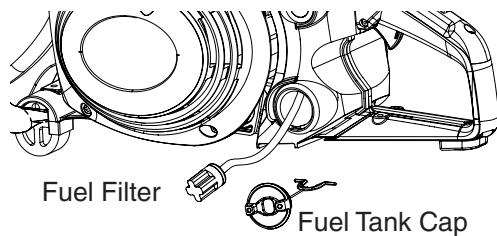

### **(Check Periodically)**

1. Do not allow dust to enter fuel tank.
2. Clogged filter will cause difficulty in starting engine or abnormalities in engine performance.
3. Pull the fuel filter out through fuel inlet port with a piece of steel wire or the like.
4. When the filter is dirty, replace it. Do not attempt to clean the filter.
5. When the inside of the fuel tank is dirty, rinsing the tank out with petrol can clean it.

### **WARNING**

**Check condition of fuel cap and gasket. Be sure the cap fits tightly and there is no fuel leak.**

### **NOTE**

Federal EPA regulations require all model year 2012 and later gasoline powered engines produced for sale in the United States to be equipped with a special low permeation fuel supply hose between the carburetor and fuel tank. When servicing model year 2012 and later equipment, only fuel supply hoses certified by EPA can be used to replace the original equipment supply hose. Fines up to \$37,500 may be enforced for using an un-certified replacement part.

## Carburetor Adjustment

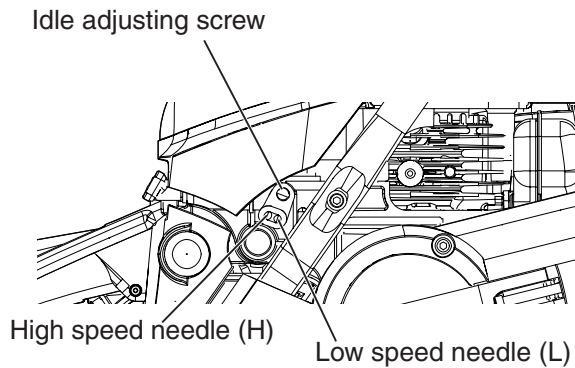

### High Altitude Operation

This engine has been factory adjusted to maintain satisfactory starting, emission, and durability performance up to 1100 feet above sea level (ASL) (96.0 kPa).

To maintain proper engine operation and emission compliance above 1100 feet ASL the carburetor may need to be adjusted by an authorized ECHO service dealer.

#### IMPORTANT

If the engine is adjusted for operation above 1100 feet ASL, the carburetor must be readjusted when operating the engine below 1100 feet ASL, otherwise severe engine damage may result.

Every unit is run at the factory and the carburetor is set in compliance with Emission Regulations. In addition, the carburetor is equipped with "H" (High Speed) and "L" (Low Speed) needle adjustment limiters that prevent settings outside acceptable limits.

1. Before adjusting carburetor clean or replace air filter and muffler "Spark Arrestor Screen".
2. Install the wheel.
3. Start engine and run several minutes to bring to operating temperature.  
Flash choke twice during warm-up to clear any air from the fuel system.
4. Stop engine.  
Turn "L" speed needle counterclockwise (CCW) to stop.  
Turn "H" speed needle midway between full clockwise (CW) stop and CCW stop.
5. Idle Speed Adjustment:
  - Start engine, turn "Idle" speed adjustment screw CW until the wheel begins to turn, then turn screw out CCW until the wheel stops turning.  
Turn screw out, CCW, an additional 1 + ½ turn.

#### WARNING

**Cutting attachment must not move when unit is idling.**

6. Accelerate to full throttle for 2 - 3 seconds to clear any excess fuel in the engine, then return to idle.  
Accelerate engine to full throttle to check for smooth transition from idle to high speed.
7. Check idle speed and reset if necessary as described in item 5.  
If a tachometer is available idle speed should be set to 2800 rpm.

#### CAUTION

**When starting, idling adjustment speed should be adjusted not to rotate the wheel. Correct idle speed is adjusted 2800 rpm. Or 1 + ½ turn CCW from the point the wheel stops moving. When you experience trouble with the carburetor, contact your dealer.**

## Cylinder Fins

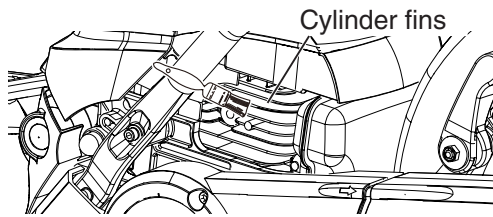

1. Check periodically.
2. Clogged fins will result in poor engine cooling.
3. Remove dirt and dust from between fins to let cooling air pass easily.

## Muffler Spark Arrestor

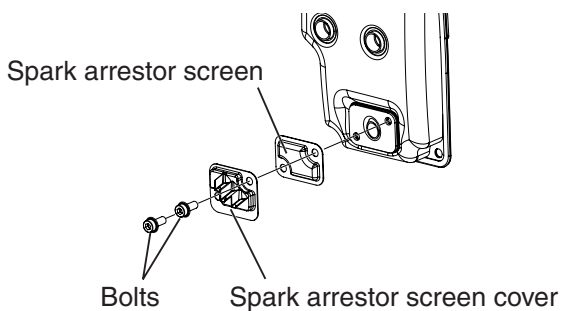

1. Remove air cleaner cover and remove spark plug lead.
2. Remove the cutter arm. (See page 30.)
3. Remove spark arrestor screen cover and screen from muffler body.
4. Clean carbon deposits from muffler components.
5. Replace screen if it is cracked, or has holes burned through.
6. Assemble components in reverse order.

### NOTE

Carbon deposits in muffler will cause drop in engine output. Spark arrestor screen must be checked periodically.

## Clutch and Maximum Speed Checks

### Clutch

Slipping of the clutch under a cutting load is not the only thing that can happen to a clutch. Another problem may appear during setting of the Carburetor for proper idling speed. The clutch may be at fault if an adjustment high enough for stable idling results in wheel rotation. Such a condition should be checked out by your servicing dealer before any further use of the saw.

### Speed



### WARNING

**To ensure the wheel does not over speed, the engine no load speed must be adjusted to a maximum of 9950 rpm. Use a tachometer to measure speed. If engine speed exceeds 9950 rpm, have the unit serviced by your nearest ECHO servicing dealer before further use.**

Whenever activated, the vibration-sensitive governor in the Carburetor high speed fuel circuit supplies more fuel than the engine can burn. Consequently, the engine has to purge itself of the extra fuel and slows down in the process. Proper high speed adjustment (see page 28) of the Carburetor should result in engine high speed, no load, operation within the desired range. This range is 9750 rpm  $\pm$  200 rpm, which is required for the proper wheel spindle speed range of 3700 – 3820 rpm.

## Belt Change and Adjustment

### Adjusting the Belt

Adjust the belt if it becomes loose.

1. Loosen the 2 pulley cover bolts about 1 turn.
2. Turn the tension screw so the washer lines up with the mark on the clutch cover.
3. Tighten the 2 pulley cover bolts. Note: Tighten to a torque of 23 to 27N·m (230 to 270 kgf·cm).

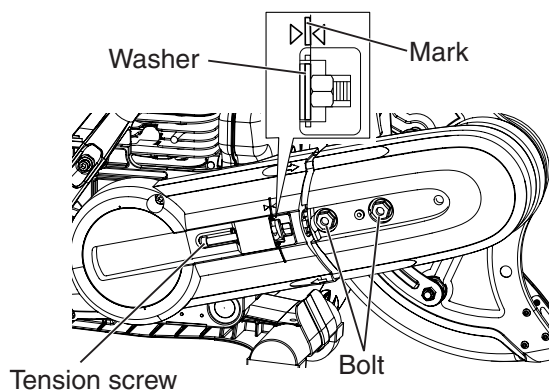

### Replacing the Belt

Replace the belt when it becomes very worn (peeling, turning, cuts, cracking, etc.)

1. Disconnect the water-flush pipe from the pipe connector.

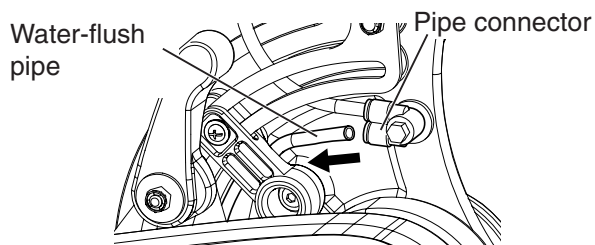

2. Loosen the tension screw and then remove the 2 pulley cover bolts.
3. Remove the pulley cover along its rail.
4. Loosen the clutch cover bolt and then remove the clutch cover.

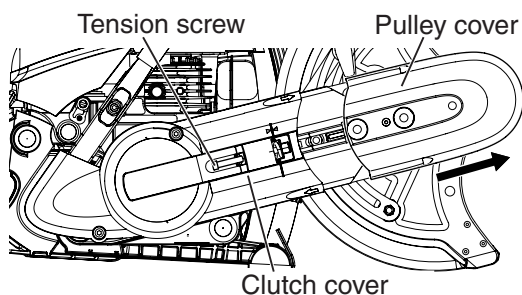

5. Remove the old belt and then remove the cutter arm.

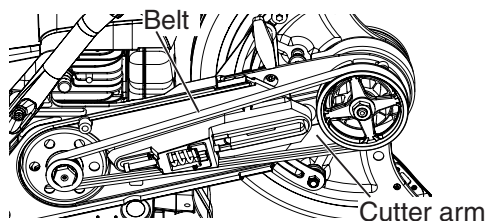

6. Put the new belt on the small pulley.
7. While pulling the belt in the direction of the cutter, install the clutch cover and fasten it with its bolt.

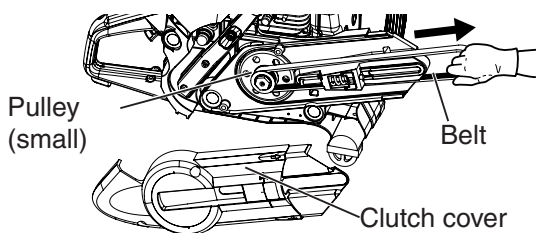

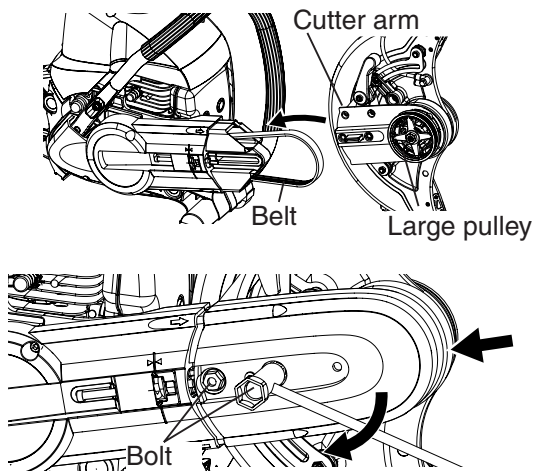

8. Fit the cutter arm into the long hole in the crankcase and then put the belt on the large pulley.
9. Put the pulley cover on along the outside of the cutter arm. Make sure the pulley cover is not misaligned when putting it into the arm.
10. Tighten the 2 pulley cover bolts and then back them off 1 turn. Adjust the tightness of the belt.
11. Tighten the 2 pulley cover bolts. Note: Tighten to a torque of 23 to 27N·m (230 to 270 kgf·cm).
12. Insert the water-flush pipe into the pipe connector.
13. The belt stretches after being replaced, so readjust its tension after operating the machine.

## Flange

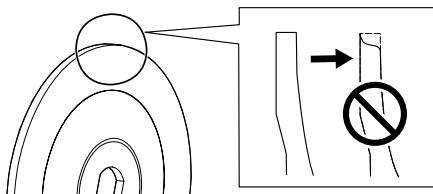

1. Check for wear, cracks and broken pieces.
2. Replace with a new one if anything is abnormal.

## Wheel Guard

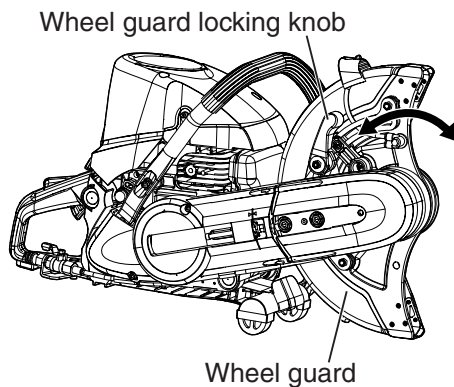

1. Make sure it does not touch the cutting wheel, as a result of deformation or rattling.
2. Consult your dealer if the wheel guard moves back and forth even when the wheel guard locking knob is tightened.
3. Consult your ECHO dealer if there is any wear or cracking.

## Troubleshooting Cutting Problems

Trouble	Probable Cause	Remedy
Wheel stops when cutting pressure is applied	<ol style="list-style-type: none"> <li>1. Bearing down too hard</li> <li>2. Binding in crooked cut</li> <li>3. Binding in closing cut</li> <li>4. Loose belt</li> </ol>	<ol style="list-style-type: none"> <li>1. Ease up cutting pressure</li> <li>2. Lay out and follow a straight line</li> <li>3. Support material so cut will open</li> <li>4. Increase belt tension</li> </ol>
Wheel stops when cutting pressure is applied	Belt worn beyond the limit	Replace belt
Poor cutting – wheel discolored at outer area	Heat damage	Replace wheel. Do not cut long in one spot. Water flush when recommended.

## Troubleshooting Engine Problems

Trouble	Probable Cause	Remedy
Engine will not start	<ol style="list-style-type: none"> <li>1. Out of fuel</li> <li>2. Engine flooded</li> <li>3. Fuel filter clogged</li> <li>4. Air filter blocked</li> <li>5. Spark plug fouled or cracked</li> <li>6. Ignition magneto or spark plug wire faulty</li> </ol>	<ol style="list-style-type: none"> <li>1. Fill fuel tank</li> <li>2. Remove spark plug                             <ul style="list-style-type: none"> <li>• Push in and hold the momentary STOP switch</li> <li>• Crank the engine to expel the fuel</li> <li>• Install clean, dry, properly gapped spark plug</li> </ul> </li> <li>3. Install clean fuel filter. Check that fuel pick-up line is not leaking or clogged. Clean fuel tank.</li> <li>4. Replace air filter element</li> <li>5. Replace plug.</li> <li>6. Contact nearest authorized ECHO servicing dealer</li> </ol>
Engine hard to start	<ol style="list-style-type: none"> <li>1. See reasons under “will not start”</li> <li>2. Water in fuel or fuel has gone stale or sour</li> <li>3. Engine not getting the proper fuel / air mixture</li> <li>4. Carburetor out of adjustment</li> </ol>	<ol style="list-style-type: none"> <li>1. See remedies above</li> <li>2. Fill tank with clean, fresh fuel mixture</li> <li>3. If over-choked and flooded:                             <ul style="list-style-type: none"> <li>• Remove spark plug</li> <li>• Push in and hold the momentary STOP switch</li> <li>• Crank the engine to expel the fuel</li> <li>• if not choked enough, set controls properly for starting</li> </ul> </li> <li>4. See “Carburetor Adjustment” or seek authorized dealer for adjustment</li> </ol>
Engine misses	<ol style="list-style-type: none"> <li>1. Dirt in Carburetor or fuel line</li> <li>2. Carburetor out of adjustment</li> <li>3. Weak or intermittent spark</li> </ol>	<ol style="list-style-type: none"> <li>1. Contact nearest authorized servicing dealer</li> <li>2. Adjust, or seek dealer service</li> <li>3. Contact nearest authorized servicing dealer</li> </ol>
Engine overheats and / or stalls under cutting load	<ol style="list-style-type: none"> <li>1. Not enough oil</li> <li>2. Air passages around cylinder clogged</li> <li>3. Carburetor main adjustment is set too “Lean”</li> </ol>	<ol style="list-style-type: none"> <li>1. Use proper amount of oil in fuel mixture</li> <li>2. Clean air intake grid on starter side, flywheel, cylinder fins and surrounding area</li> <li>3. See “Carburetor Adjustment” or seek authorized dealer for adjustment</li> </ol>

## STORAGE AFTER USE

### **WARNING**

Momentary stop switch automatically returns to run position. Engine can start unintentionally when starter handle is pulled. Always remove spark plug lead from spark plug before pulling starter handle, otherwise severe personal injury may result.

- Inspect and adjust every part of the engine cut-off saw.
  - Completely clean every part and repair if necessary.
  - Apply thin coating of oil on metal parts to prevent rust.
- Remove wheel.
- Drain fuel tank, pull starter slowly a few times to drain fuel from carburetor.
- Pour a small amount of clean motor oil into spark plug hole, pull starter and crank the engine until piston reaches: TOP DEAD CENTER.
- Store in a dry area, free from dust.

### **WARNING**

Do not store in an enclosure where fuel fumes may accumulate or reach an open flame or spark.

### **CAUTION**

Do not lend or rent your engine cut-off saw without the Operator's Manual.

### **NOTE**

- For future reference, you should keep this Operator's Manual.
- If this Operator's Manual has become illegible or is lost, please purchase a new one from your ECHO dealer.



## TECHNICAL DATA

Model		<b>CSG-7410</b>
<b>External dimensions</b> : Without cutting wheel Length × Width × Height	mm (in)	620 × 240 × 407 (24.4 × 9.4 × 16.0)
<b>Mass</b> : Without cutting wheel and empty tank	kg (lb)	10.7 (23.6)
<b>Volume</b> :		
Fuel tank	mL (US fl. oz.)	700 (23.67)
Fuel ( Mixture ratio )		50:1 ratio with ECHO brand oil, ISO-L-EGD (ISO/CD 13738), JASO M345-FC/FD two-stroke, air-cooled en- gine oil.  Use 89 octane unleaded. Do not use fuel containing methyl alcohol, more than 10% ethyl alcohol or 15% MTBE.
<b>Engine</b> :		
Type		Air-cooled, two-stroke, single cylinder gasoline engine
Engine displacement	mL (cu.in.)	73.5 (4.49)
Carburetor		Diaphragm type, Inner vent type
Magneto		Flywheel magneto, CDI type
Spark plug		NGK BPMR7A
Starter		Recoil starter
Clutch		Centrifugal type
Maximum shaft brake power	kW	3.2
Wide open throttle speed	rpm	9650 (9350-9750)
Idle speed	rpm	2800 (2600-3000)
Throttle control		Throttle trigger with throttle lockout
<b>Cutting device</b> :		
Belt		6PJ-808
Pulley ratio		2.57 : 1
Belt tensioner		Coil Spring system
Wheel	mm (in.)	350 × 4.7 × 20 (14 × 6/32 × 25/32)
Maximum cut-off wheel speed	rpm	3820
Flange outside diameter	mm	100
Wheel fastener tightening torque	N•m	25 - 30
Maximum spindle speed rating	rpm	3820
<b>Sound pressure level</b> : measured at 15 m (50 ft)	dB(A)	78.2
<b>Other device</b> :		
Vibration reduction system		Rubber mounted between the engine and the handles

\* Technical data subject to change without notice.

# WARRANTY REGISTRATION SHEET

Thank you for choosing ECHO Power Equipment

Please go to <http://www.echo-usa.com/Warranty/Register-Your-ECHO> to register your new product on-line. It's **FAST** and **EASY!** NOTE: your information will never be sold or misused by ECHO, Inc. Registering your purchase enables us to contact you in the unlikely event of a service update or product recall, and verifies your ownership for warranty consideration.

If you do not have access to the Internet, you can complete the form below and mail to:

**ECHO Inc., Product Registration, PO Box 1139, Lake Zurich IL 60047.**

## **ECHO** PRODUCT REGISTRATION CARD : TARJETA DE REGISTRO : CARTE D'ENREGISTREMENT DU PRODUIT

**ONLINE OPTION:** Register online and save a stamp! You will be alerted of product updates and/or be sent new ECHO product information and special offers. Simply go to: [www.echo-usa.com](http://www.echo-usa.com)

**OPCIÓN POR INTERNET:** Regístrese en la página web y ahorre una estampilla! Le alertarán sobre actualizaciones del producto y/o se le enviará información sobre los nuevos productos ECHO y las ofertas especiales. Simplemente visite: [www.echo-usa.com](http://www.echo-usa.com)

**OPTION EN LIGNE :** Enregistrer en ligne et épargner un timbre! Vous serez informé sur les nouveaux produits ECHO et les mises à jour de produit ainsi que les offres spéciales. Simplement visitez le: [www.echo-usa.com](http://www.echo-usa.com)

**Please Print :** Por Favor Escriba Con Letra De Molde : En Lettre Carré S.V.P.

**Confidential:** Information provided will not be shared or sold

Purchaser's Name : Nombre del Comprador : Nom de l'acheteur	
Address : Dirección : Adresse	
City : Ciudad : Ville	State : Estado : Province
Zip Code : Código Postal : Code Postal	
E-Mail Address : Dirección De Correo Electrónico : Courrier Electronique	
Phone Number : Número De Teléfono : Téléphone	Date of Purchase : Fecha de la Compra : Date de l'achat
Where Purchased : Nombre del Almacén donde fue Comprado : Lieu d'achat	
Model Number : Número del Modelo : No. de modèle	Serial Number : Número de Serie : No. de série

Registering your purchase enables us to contact you in the unlikely event of a service update or product recall and verifies your ownership in the event of loss. El registrar su compra nos permite estar en contacto con usted en caso de cualquier evento como el aviso de tiempo de servicio o la revocación del producto y verificación de propiedad en caso de robo o pérdida. L'enregistrement de votre achat nous permettra de vous contacter dans le cas improbable de modifications des instructions d'entretien ou de rappel du produit et vérifier que vous êtes le propriétaire en cas de vol ou de perte.

Primary use of tool:  Professional  Homeowner  Rental Equip.  
 Uso primario de la herramienta:  Profesional  Dueño de casa  Alquiler  
 Usage principal:  Professionnel  Residential  Location

Do you wish to receive periodic ECHO product information and special offers by e-mail?  Yes  No  
 ¿Desea usted recibir información periódica y ofertas especiales por correo electrónico sobre el producto ECHO?  Yes  No

Souhaitez-vous recevoir périodiquement de l'information sur les produits ECHO et les offres spéciales par courrier électronique?  Oui  Non

Did you visit the ECHO website before purchasing your product?  
 Yes  No  
 Visité usted la página web ECHO antes de comprar su producto?  
 Si  No  
 Avez-vous visité le site d'ECHO avant de procurer votre produit?  
 Oui  Non

What factor(s) most influenced your purchase?  
 Performance  Price  Dealer  
 Reliability  Prior Experience  Quality  
 Friend/Family  Brand  Warranty

¿Qué factor(es) influyó más en su compra?  
 Funcionamiento  Precio  Distribuidor  
 Confiabilidad  Experiencia Anterior  Calidad  
 Amigo/Familia  Marca  Garantía

Quel facteur (facteurs) vous a influencé le plus?  
 Performance  Prix  Marchand  
 Fiabilité  Expérience  Qualité  
 Ami/Famille  Marque  Garantie

**ECHO INC., 400 Oakwood Rd., Lake Zurich, IL 60047**  
**1.800.432.ECHO WWW.ECHO-USA.COM**

X7572270206 02-2012

# NOTES



C72715001001 – C72715999999