

BOSS

SNOWPLOW

KEEP 'EM

OPEN





Everything we do at BOSS drives to one goal: arming snow and ice removal professionals with everything they need to **RESTORE ORDER** when winter weather brings chaos. That's why we never stop pushing our designs, engineering and innovations to help make your job easier and more productive. Because at BOSS, our promise is that we will always be there to **BACK YOU UP**.

BOSS Products, a division of The Toro Company, reserves the right under its product improvement policy to change construction or design details and furnish equipment when so altered without reference to illustrations or specifications used herein.
*All images shown may include standard/optional equipment. Please consult your local BOSS Dealer for more information.



TABLE OF CONTENTS

- 4** BOSS Innovations
- 6** DXT
- 8** XT
- 9** HTX
- 10** DRAG PRO®
- 12** EXT
- 14** Super-Duty Full-Trip
- 15** Super-Duty Trip-Edge
- 16** Heavy-Duty Straight-Blade
- 17** Heavy-Duty DXT
- 18** VBX Hopper Spreaders
- 19** FORGE® Hopper Spreaders
- 20** TGS Tailgate Spreaders
- 21** Genuine Truck Equipment Parts & Accessories
- 22** Genuine Ice Control Accessories
- 23** Specifications
- 30** Spreader Material Guide

INNOVATING FOR THE WAY YOU WORK



ROLL WITH WINTER'S PUNCHES

When winter is at its worst, the job calls for more than muscle, which is why BOSS engineers smart, tough, innovative solutions to make snow and ice removal fast, easy and efficient. With a variety of snow and ice control technologies and features to make your job more productive, BOSS has what today's professionals need to take on winter and RESTORE ORDER.





FIRST WITH STANDARD LED TECHNOLOGY

Plow in a whole new light with best-in-class, DOT-compliant, 100% LED lighting, integrated with Ice Shield Technology™ to prevent snow and ice build-up on the lens. Comes standard on all BOSS truck plows. (Excludes DRAG PRO®.)



FLEET-FLEXIBLE FRONT-MOUNTED UNDERCARRIAGE

Quickly and easily swap between snowplows in your BOSS fleet. For complete details see your BOSS Dealer.



ATTACH WITH EASE

Attach your plow in just three easy steps with the easy-to-use SmartHitch® 2 attachment system. (Excludes DRAG PRO®.)



SUPERIOR HAND CONTROLS

Our high-tech, ergonomic controls feature large, backlit buttons for ease of use.

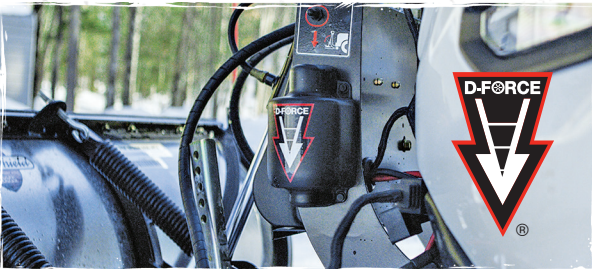

D-FORCE®

Enhance your backdrag performance with D-Force®. D-Force® maintains consistent hydraulic down force through the use of a hydraulic accumulator. Available for select straight-blade and DXT truck plows. (Excludes XT, EXT, Heavy-Duty, Trip-Edge and DRAG PRO® snowplows.)



SMARTSHIELD®

Delivers superior corrosion protection and a long-lasting, high-gloss shine.



SNOW DEFLECTOR

For increased visibility and safety in a snowstorm, make sure you're prepared with the rubber snow deflector.



BACKDRAG EDGE

Consider adding a backdrag edge to enhance your backdrugging performance. Available for select straight-blade and V-plows. (Excludes DXT, EXT, Trip-Edge and Heavy-Duty.)

DXT



ROLL OUT THE HEAVY HITTERS

Extreme conditions demand cutting-edge innovation. The durable, fully featured BOSS DXTs are the ultimate tools to fight all things snow and ice. The DXT combines both trip-edge and full moldboard trip technologies for high and low trip protection when striking hidden obstacles like frozen snowbanks, manhole covers and curbs. Flared wings with enhanced curl throw snow with maximum efficiency and the DXT's multi-position plow blade can quickly and easily switch positions to move large amounts of snow.



STANDARD FEATURES

- **Patented Dual-Trip Design** combines trip-edge and full moldboard trip technologies, enhancing plow protection when striking hidden obstacles no matter your plow's position.
- **SmartLight™ 3 LED Headlight System** uses DOT-compliant 100% LED lights and Ice Shield Technology™ to prevent snow and ice build-up.
- **½" x 6" Long-Lasting, Durable Base Angle** provides extended wear resistance with built-in curb guards and patented snow catcher. The base angle serves as the plow's cutting edge until a certain wear point.
- **Optimized Hydraulics** streamline function and reliability of V-plows using fewer valves and hoses and fewer cycles on your electrical system.
- **Patented Snow Catcher** catches snow at the plow's pivot point, so no snow lines are left behind.
- **Reinforced Moldboard** increases blade rigidity for increased durability.
- **Heavy-Duty Push Frame and Center Section** provide additional strength and reliability.
- **SmartLock® Cylinders** lock blades in place when backdragging.

> MODELS

Steel 8'2", 9'2", 10'

Stainless Steel 8'2", 9'2"

Poly 8'2", 9'2"

> OPTIONAL ACCESSORIES

- D-Force®
- Snow Deflector
- Plow Wings
- Caster Wheels
- Cast-Iron Plow Shoes



Keep your blade in contact with the pavement with D-Force®. D-Force® improves scraping performance while backdragging by maintaining a consistent hydraulic down force powered by a hydraulic accumulator. D-Force® is an optional accessory on new 8'2" and 9'2" DXT plow purchases.



POWER PUNCH

The flared wings and enhanced blade curl of DXT snowplows power through and throw snow farther than traditional snowplows.

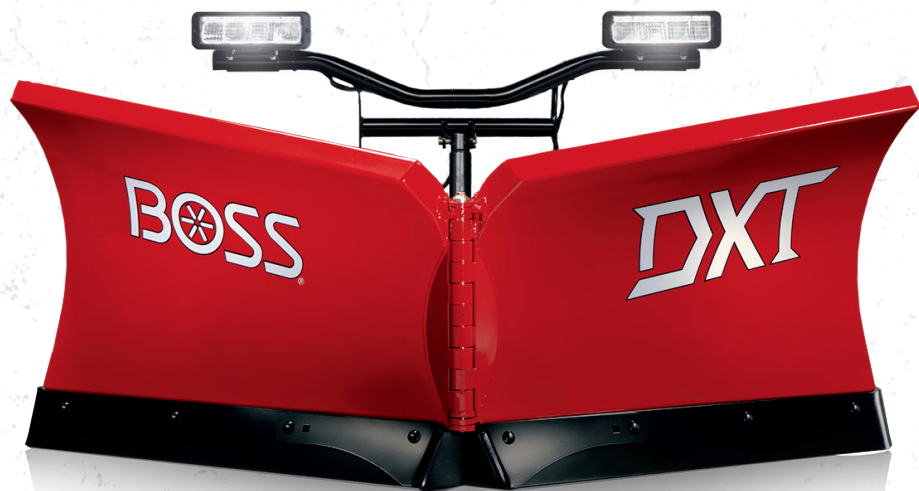

DXT



SEE IT IN ACTION
BOSSPLOW.COM

XT

THE POWER TO PERFORM

The BOSS XT plow's flared blade wings and enhanced curl design throw snow higher and farther than conventional snowplows, while the full moldboard trip design helps prevent plow damage when an obstacle is encountered. The XT is designed to take on winter's worst with a heavy-duty push frame and center section. Available in poly, steel or stainless steel, the BOSS XT is a proven innovation that is built to BACK YOU UP.



STANDARD FEATURES

- **Full Moldboard Trip Design** helps to prevent plow damage when an obstacle is encountered.
- **SmartLight™ 3 LED Headlight System** uses DOT-compliant 100% LED lights and Ice Shield Technology™ to prevent snow and ice build-up.
- **½" x 6" Cutting Edge** built using a wear plate provides extended wear resistance and comes with built-in curb guards and patented snow catcher.
- **Patented Snow Catcher** catches snow at the plow's pivot point, leaving no snow lines behind.
- **Reinforced Moldboard** increases blade rigidity for increased durability.
- **Heavy-Duty Push Frame and Center Section** provide additional strength and reliability.
- **SmartLock® Cylinders** lock blades in place when backdragging.



> MODELS

Steel 7'6", 8'2", 9'2"
Poly 8'2", 9'2"

Stainless Steel 8'2", 9'2"

> OPTIONAL ACCESSORIES

- Urethane Cutting Edge
- Cast-Iron Plow Shoes
- Plow Wings
- Caster Wheels
- Snow Deflector
- Backdrag Edge



HTX

PERFORM ABOVE YOUR WEIGHT CLASS

The HTX plow RESTORES ORDER with the same features as BOSS full-size straight-blade and V-plows, built specifically for half-ton trucks. Built with business owners and homeowners in mind, the HTX line offers a strong, durable push frame and quadrant to clean up driveways and small business parking lots with a light-duty vehicle.

STANDARD FEATURES

- **Full Moldboard Trip Design** helps prevent plow damage when an obstacle is encountered.
- **Optimized Hydraulics** streamline function and reliability of V-plows using fewer valves and hoses and fewer cycles on your electrical system.
- **SmartLight™ 3 LED Headlight System** uses DOT-compliant 100% LED lights and Ice Shield Technology™ to prevent snow and ice build-up.
- **Strong, Durable Push Frame** adds strength and reliability.
- **SmartLock® Cylinders** lock blades in place when backdragging (HTX V-plow only).

> MODELS

- Steel **V-Plow 7'6"**
- Steel **Straight-Blade 7', 7'6"**
- Poly **Straight-Blade 7', 7'6"**
- Stainless Steel **Straight-Blade 7', 7'6"**

> OPTIONAL ACCESSORIES

- Urethane Cutting Edge
- Cast-Iron Plow Shoes
- Backdrag Edge
- Caster Wheels
- Snow Deflector
- D-Force® (Straight-Blade Only)



7'6" HTX V-Plow Steel



D-Force® maintains consistent hydraulic down force through the use of a hydraulic accumulator to improve scraping performance while backdragging. D-Force® is an optional accessory on new truck plow purchases. Only available for HTX straight-blade plows.



7', 7'6"
Stainless Steel



DRAG PRO®



TIME SAVED IS MONEY EARNED

The BOSS DRAG PRO® brings power and productivity to the back of your truck. The DRAG PRO® mounts from the rear, allowing you to pull snow from the back while clearing large areas like commercial parking lots. Expand the hydraulic folding wings up to a maximum of 16' to clear more snow with each pass—saving time and money. The down force of the plow helps the DRAG PRO® scrape more cleanly and efficiently than traditional plows, especially in wet snow. Pair with BOSS V-plows, straight-blade plows or EXT plows for the ultimate plowing rig.



STANDARD FEATURES

- **Hydraulic Folding Wing Models** expand plow width from 8' to 12' or 8' to 16'.
- **Independent Wing Control** is featured on expanding wing models with hydraulic relief protection.
- **Low-Profile Coupler Design** allows for unobstructed tailgate use and visibility.
- **Easy Attach/Detach** saves time for quick operation on 4WD, ¾-ton and 1-ton trucks.
- **High-Performance Hydraulic Package** delivers reliability and speed.
- **Hydraulic Flow Control Valve** allows adjustment of the raise/lower speed.
- **Steel Blade Cutting Edge** and urethane wing edges are included.
- **Molded-In Urethane Snow Catchers** ensure no snow is left behind when plowing.



> MODELS

8' Fixed Wing

8'-16' Hydraulic Folding Wing

8'-12' Hydraulic Folding Wing

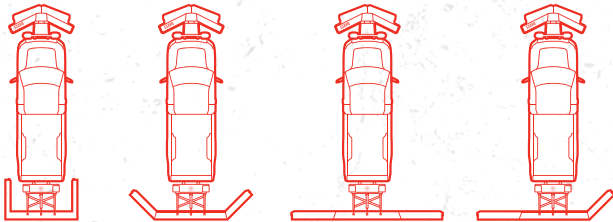

Multiple wing configurations provide added versatility to quickly and easily clear the job site.



TIME SAVER

Make quick work of even the biggest jobs by adding a DRAG PRO® to the back of your truck.



PRODUCTIVITY BOOSTER

Make the most of every minute. The DRAG PRO® speeds up snow clearance, making every job faster and easier.

DRAG PRO®
8'-12' Retracted



DRAG PRO®



SEE IT IN ACTION
BOSSPLOW.COM

Ask Your BOSS Dealer About
Optional Rubber Edge Kit

Intended Uses: Driveways, Loading Docks, Empty Parking
Lots and Occupied Parking Lots/Aisles

EXT



EXPAND PARKING LOT PRODUCTIVITY

Quickly and easily expanding from 8 to 10 feet at the touch of a button, the BOSS EXT is equipped to clean up parking lots and wide open spaces. A true 10-foot width combined with pitched-forward wings lets the EXT take wider passes, carrying and moving more snow more efficiently. At 30 inches high with 9 vertical ribs, the EXT moves a high volume of snow with resilience, making it a versatile and flexible addition to your fleet. Another powerful tool in your plowing arsenal that's built to BACK YOU UP.



STANDARD FEATURES

- **Expandable, Fully Hydraulic, Pitched-Forward Wings** expand from 8' to 10' to cover more ground.
- **SmartLight™ 3 LED Headlight System** uses DOT-compliant 100% LED lights and Ice Shield Technology™ to prevent snow and ice build-up.
- **Reinforced Moldboard** increases blade rigidity for increased durability.
- **Heavy-Duty Push Frame and Attachment Bar** adds strength and increases performance by spreading loads out over a wider area.
- **Open Plow Back Design** prevents snow and ice build-up to maintain optimal wing retraction.

> MODEL

Steel 8' Retracted, 10' Expanded



> 8' retracted



> 10' expanded



> Independent wing extension



PRODUCTIVITY BOOSTER

Quickly expand to a true 10-foot blade for wider passes that efficiently move more snow.



EXT
10' Expanded With Pitched-Forward Wings

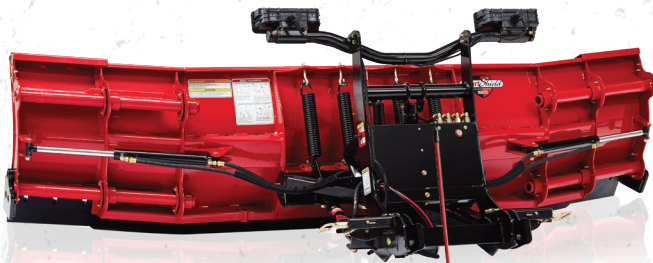

Our BOSS joystick controller option is now available for EXT plows. Joystick controllers offer the versatility of right- or left-hand adjustment.



Ask Your BOSS Dealer About Optional Snow Deflector.

EXT



SEE IT IN ACTION
BOSSPLOW.COM

SUPER-DUTY FULL-TRIP

TRIED & TRUSTED

BOSS Super-Duty straight-blade plows RESTORE ORDER with unsurpassed reliability and strength. BOSS SmartShield® baked-on powdercoat paint finishes with zinc primer resist corrosion. Heavy-duty push frames and push frame attachment bars and optimized blade curl are standard on every BOSS straight-blade. For added strength to take on nature's worst, BOSS Super-Duty straight-blades boast reinforced moldboards for increased blade rigidity and increased durability.

STANDARD FEATURES

- **Full Moldboard Trip Design** helps to prevent plow damage when an obstacle is encountered.
- **SmartLight™ 3 LED Headlight System** uses DOT-compliant 100% LED lights and Ice Shield Technology™ to prevent snow and ice build-up.
- **Cast-Iron Plow Shoes** extend the life of the cutting edge and protect the plowing surface.
- **Blade Shock Absorber** stabilizes and cushions the trip action.
- **Heavy-Duty Push Frame and Attachment Bar** adds strength and increases performance by spreading loads out over a wider area.
- **Reinforced Moldboard** increases blade rigidity for increased durability.

> MODELS

Super-Duty Steel 7'6", 8', 8'6", 9' Super-Duty Poly 7'6", 8'



8' Steel Super-Duty



D-Force® maintains consistent hydraulic down force through the use of a hydraulic accumulator to improve scraping performance while backdragging. D-Force® is an optional accessory on new truck plow purchases.

> OPTIONAL ACCESSORIES

- Urethane Cutting Edge
- Backdrag Edge
- Snow Deflector
- Plow Wings
- Curb Guards
- Caster Wheels
- D-Force®



SUPER-DUTY TRIP-EDGE

ROLL WITH WINTER'S PUNCHES

BOSS Trip-Edge snowplows are engineered to power through the heaviest snow and any obstacles that come with it. The extra-rigid moldboard and trip-edge technology ensure that only the cutting edge trips when you hit an obstacle, so you won't lose the load you're pushing. Trip-Edge snowplows feature four adjustable trip return springs, so you can customize the trip spring tension for the job at hand.

STANDARD FEATURES

- **Trip-Edge Design** helps prevent plow damage when an obstacle is encountered.
- **SmartLight™ 3 LED Headlight System** uses DOT-compliant 100% LED lights and Ice Shield Technology™ to prevent snow and ice build-up.
- **Adjustable Trip Springs** allow customization of the trip spring tension.
- **Cast-Iron Plow Shoes** extend the life of the cutting edge and protect the plowing surface.
- **Reinforced Moldboard** increases blade rigidity for increased durability.
- **Heavy-Duty Push Frame and Attachment Bar** adds strength and increases performance by spreading loads out over a wider area.

> MODELS

Steel 7'6", 8', 9'

Stainless Steel 8', 9'

> OPTIONAL ACCESSORIES

- Snow Deflector
- Curb Guards
- Plow Wings



TRIP-EDGE DESIGN

The base angle trips back to protect the plow and truck from damage when obstacles are encountered.

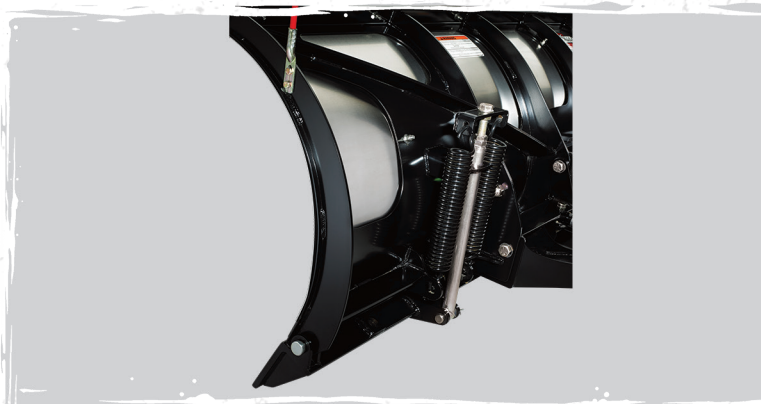

ADJUSTABLE TRIP SPRINGS

Adjustable BOSS trip springs let the operator adjust the trip-edge tension according to the job at hand.



HEAVY-DUTY STRAIGHT-BLADE

WHEN WINTER HITS HARD, HIT BACK HARDER

Designed for medium-duty trucks, BOSS Heavy-Duty straight-blade plows are available in 9-foot and 10-foot options. BOSS Heavy-Duty straight-blades feature a reinforced moldboard with enhanced blade curl design to power through deep, wet snow. BOSS Heavy-Duty straight-blades come standard with the SL3 headlight system with Ice Shield Technology™ to handle every job, even in the darkest conditions. Because when it's on you to RESTORE ORDER, BOSS is always there to BACK YOU UP.

STANDARD FEATURES

- **Full Moldboard Trip Design** helps prevent plow damage when an obstacle is encountered.
- **SmartLight™ 3 LED Headlight System** uses DOT-compliant 100% LED lights and Ice Shield Technology™ to prevent snow and ice build-up.
- **Cast-Iron Plow Shoes** extend the life of the cutting edge.
- **Dual Shock Absorbers** stabilize and cushion the trip action.
- **Heavy-Duty Push Frame and Attachment Bar** add strength and reliability.
- **Reinforced Moldboard** increases blade rigidity for increased durability.

> MODELS

Steel Heavy-Duty Straight-Blade 9', 10'

> OPTIONAL ACCESSORIES

- Urethane Cutting Edge
- Snow Deflector
- Curb Guards



10' Heavy-Duty
Straight-Blade Steel



HEAVY-DUTY DXT

HEAVY-DUTY DUAL-TRIP POWER AND PERFORMANCE

The 10-foot BOSS DXT is the next generation snowplow for medium-duty trucks. With V-plow versatility, the BOSS DXT allows you to scoop, stack and punch through hard-packed banks with power and performance. The BOSS DXT patented dual-trip technology provides enhanced plow protection when striking hidden obstacles—in any blade position. The BOSS DXT comes standard with the SL3 headlight system with Ice Shield Technology™ for increased visibility, even in the darkest conditions—ensuring that no matter what Mother Nature throws your way, BOSS is always there to BACK YOU UP.

STANDARD FEATURES

- **Patented Dual-Trip Design** combines trip-edge and full moldboard trip technologies, enhancing plow protection when striking hidden obstacles no matter your plow's position.
- **SmartLight™ 3 LED Headlight System** uses DOT-compliant 100% LED lights and Ice Shield Technology™ to prevent snow and ice build-up.
- **½" x 6" Long-Lasting, Durable Base Angle** provides extended wear resistance with built-in curb guards and patented snow catcher. The base angle serves as the plow's cutting edge until a certain wear point.
- **Cast-Iron Plow Shoes** extend the life of the cutting edge (standard on Heavy-Duty, optional on 10' DXT).



- **Heavy-Duty Push Frame and Attachment Bar** add strength and reliability.
- **Reinforced Moldboard** increases blade rigidity for increased durability.

> MODELS

Steel DXT 10'

> OPTIONAL ACCESSORIES

- Cast-Iron Plow Shoes
- Snow Deflector

10' DXT Steel



VBX HOPPER SPREADERS

MAXIMUM SPEED & EFFICIENCY

BOSS hopper spreaders are some of the most powerful tools in your snow and ice removal arsenal. BOSS VBX spreaders are fully featured, outfitted with features for ease of use and maximum productivity for years of operation in harsh winter conditions. The VBX family features models with either pintle or auger feeds, powerful electric motors, standard worklights, easy-to-use controls and the flexibility to spread a variety of deicing materials.

STANDARD FEATURES

- **Material Feed System** features a heavy-duty pintle chain or powder-coated auger for long life and durability.
- **Poly Hopper** is built to outlast the elements.
- **Dual Variable Speed Controller** is equipped with auto-reverse (auger only) and overload protection.
- **LCD Screen In-Cab Controller** is backlit for clear visibility and ease of use.
- **14.5" Diameter Urethane Spinner** is durable and corrosion-resistant and ensures consistent distribution.
- **Enclosed Spinner Motor** is weather- and dust-resistant to ensure performance, durability and reliability.
- **Tarp With Integrated Tie-Downs** protects spreading material from the elements.
- **Dual Variable Speed Vibrators** reduce material bridging for ease of operation (standard for auger; optional for pintle).
- **Inverted V-Baffle** reduces material build-up for optimal spreading efficiency (standard for auger; available as an accessory for pintle).
- **Chain Cleaning Brush** removes excess material from chain on every pass (pintle chain only).
- **Full-Length Slide-Out Tray** captures falling deicing material, keeping it away from truck bed, preventing corrosion (pintle chain only).



> MODELS

Poly VBX 6500, VBX 8000, VBX 9000

> OPTIONAL ACCESSORIES

- Backup Camera
- Inverted V*
- Pre-Wet
- Vibrator Kit*

*Standard on auger, optional on pintle.



VBX 9000
3 cubic yards of capacity

PRE-WET

Optional pre-wet allows contractors to pre-wet solid deicing material, improving material performance.

VBX



SEE IT IN ACTION
BOSSPLOW.COM

FORGE® HOPPER SPREADERS

FIGHT ICE WITH STEEL

The BOSS FORGE® lineup is expanding to better accommodate long bed trucks for optimal fit and ease of filling. The FORGE® stainless steel hopper is constructed with a combination of bolting, riveting and welding for optimal durability and serviceability throughout the spreader's lifetime—allowing you to maintain and replace individual parts rather than the entire unit. Both the hopper and the drive train are constructed with stainless steel, enhancing the sturdiness and durability of FORGE®.

STANDARD FEATURES

- **Material Feed System** features a heavy-duty pintle chain or powder-coated auger for long life and durability.
- **Stainless Steel Hopper** is built to outlast the elements and is available in 1.0, 1.5 and 2.0 cubic yard capacity.
- **Dual Variable Speed Controller** is equipped with auto-reverse and overload protection and is backlit for clear visibility and ease of use (auger only).
- **14.5" Diameter Urethane Spinner** is durable and corrosion-resistant and ensures consistent distribution.
- **Enclosed Spinner Motor** is weather- and dust-resistant to ensure performance, durability and reliability.
- **Vibrator** reduces material bridging for ease of operation (standard for auger, optional for pintle).
- **Inverted V-Baffle** reduces material build-up for optimal spreading efficiency (standard for auger; available as an accessory for pintle).
- **Chain Cleaning Brush** removes excess material from chain on every pass (pintle chain only).
- **Full-Length Slide-Out Tray** captures falling deicing material, keeping it away from truck bed, preventing corrosion (pintle chain only).



HOPPER SPILL GUARDS

Protect the bed of the truck from salt spills when filling FORGE® 1.0 and 1.5 spreaders. Spill guards widen the top width of the spreader, making loading with loader buckets easier. (Excludes FORGE® 2.0 Long Bed.)

> MODELS

Stainless 1.0, 1.5, 2.0 Long Bed

> OPTIONAL ACCESSORIES

- Backup Camera
- Spill Guards (excludes 2.0 Long Bed)
- Light Kit
- Tarp
- Extension Kit
- Vibrator Kit*
- Inverted V*

*Standard on auger, optional on pintle.



FORGE® 2.0 Long Bed
2 cubic yards of capacity
Longer hopper makes loading simpler with loader bucket.



FORGE® 1.5
1.5 cubic yards of capacity
(shown with pre-wet)

TGS TAILGATE SPREADERS

A JOB DONE RIGHT, FAST

The TGS spreader series from BOSS is the easiest way to arm yourself against all things snow and ice. BOSS tailgate-mounted spreaders attach easily and disperse deicing materials quickly and efficiently to make your job as smooth and steady as possible. All TGS spreaders are built tough to handle harsh conditions, because BOSS knows the faster you can RESTORE ORDER to your community, the better.

STANDARD FEATURES

- **Adjustable Feed Gate** allows you to adjust the material discharge amount. (Optional on TGS 300. TGS 300 includes Material Saver System.)
- **Poly Adjustable Material Deflector** allows you to adjust the material discharge width and direction pattern.
- **12" Diameter Urethane Spinner** is durable and corrosion-resistant and ensures consistent distribution.
- **Enclosed 12-Volt Electric High-Torque Spinner Motor** is weather- and dust-resistant to ensure performance, durability and reliability.
- **Low-Profile Poly Hopper Design** provides better visibility.
- **Variable Speed Control** with LED digital display is equipped with blast feature and overload protection. (LED digital display is not available on TGS 800.)
- **Choose Your Attachment System** with a slide-in system or the RT3 system. (RT3 is not available on TGS 300.)
- **Solid Poly Hopper Cover** protects against weather and is made to last.
- **Stabilizer Arms and Tie-Down Straps** minimize any side-to-side movement. (Stabilizer arms are not available on TGS 300.)
- **Top Screen With Bag Splitter** easily opens bags and filters deicing material. (Bag splitter is not included on TGS 300.)
- **Enclosed Feed Motor** powers the feed paddle mechanism with 12 volts of high-torque electric power. (TGS 800 only.)



Optional RT3 Attachment System allows you to easily attach and detach your spreader. (Not available on TGS 300.)



- **Swing-Away Spinner Assembly** allows for quick removal of leftover material (TGS 800 only).
- **Material Saver System** eliminates material flow of fine deicers when spreader is in transport.

> MODELS

Poly TGS 300, TGS 600, TGS 800, TGS 1100

> OPTIONAL ACCESSORIES

- TGS Vibrator Kit*
- Material Saver System**
- RT3 Attachment System*

*Excludes TGS 300.
**Standard on TGS 300.



GENUINE TRUCK EQUIPMENT PARTS & ACCESSORIES

TRUCK OPTIONS



D-FORCE®

Improve backdragging performance by adding D-Force® to your new Super-Duty and HTX straight-blade plow, or your new 8'2" and 9'2" DXT V-plow. D-Force® improves scraping performance while backdragging by maintaining a consistent hydraulic down force powered by a hydraulic accumulator. D-Force® is an optional accessory on new truck plow purchases and must be added at the time of purchase. D-Force® includes D-Force®-specific hydraulic package and controller. Retrofit kits are not available. (Excludes EXT, XT, Heavy-Duty, Trip-Edge and DRAG PRO® plows.)

BLADE PERFORMANCE

BACKDRAG EDGE

Enhance the use of D-Force® and improve scraping performance when backdragging. Available accessory on select straight-blade and V-plow models. (Excludes 9' and 10' Heavy-Duty, EXT, Trip-Edge and DXT plows.)

CURB GUARDS

Protect the edges of your plow with these long-lasting, high-impact curb guards. Fits select straight-blade snowplow models. (Excludes HTX, EXT and DRAG PRO®.)

URETHANE CUTTING EDGES

Genuine BOSS urethane cutting edges are great for protecting surfaces and cover a wide range of straight-blade and V-plow models. Straight-blade edges feature a BOSS logo wear indicator. V-blade cutting edges feature built-in curb guards and our patented snow catcher. (Excludes Trip-Edge and DXT.)



RUBBER SNOW DEFLECTOR

Keep snow from blowing onto your windshield while increasing visibility and safety with a rubber snow deflector, specifically designed for BOSS snowplows.

DRAG PRO® RUBBER EDGE KIT

Improve scraping performance and protect surfaces with the DRAG PRO® Rubber Edge Kit.

PLOW WINGS

Increase your blade width by a full 22" and decrease your plowing time with optional plow wings. Attach and detach within seconds. (Excludes HTX, DRAG PRO®, 10' DXT and Heavy-Duty plows.) Available in poly and stainless steel.

LIGHTING OPTIONS

SL3 WITH ICE SHIELD TECHNOLOGY™ UPGRADE KITS

SL3 headlights with Ice Shield Technology™ are standard on new plow purchases. Upgrade your existing SmartLight™ 1 or SmartLight™ 2 halogen headlights to the 100% LED SL3 headlights with Ice Shield Technology™ for best-in-class lighting. In addition to Ice Shield Technology™, BOSS SL3 headlights offer a precision light pattern for improved driver visibility. LED lights also have a longer life expectancy and are ultra-efficient compared to halogen systems.

CONTROLLERS

SMARTTOUCH® 2 CONTROL

Our high-tech SmartTouch® 2 ergonomic control features large, backlit buttons for ease of use on a straight-blade, V-plow, DRAG PRO® and EXT.



JOYSTICK CONTROL

Our BOSS joystick controller option is now available for EXT plows. Joystick controllers offer the versatility of right- or left-hand adjustment and are also available for straight- and V-blade plows.

PLOW ENHANCEMENTS

CAST-IRON PLOW SHOES

These ultra-rugged, cast-iron shoes deliver extended wear resistance compared to conventional steel shoes.



CASTER WHEELS

Caster wheels are ideal for moving your plow around the garage or service bay. BOSS caster kits utilize existing shoe holders on the blade, making moving your plow a breeze. These heavy-duty wheels feature steel ball bearings for smooth movement and long-lasting life. Separate kits are available for straight-blades and V-plows. (Excludes Trip-Edge straight-blade, 10' DXT and Heavy-Duty straight-blade plows.)

CONTROL MOUNTING OPTIONS

Pedestal mount or dash mount is available for the BOSS SmartTouch® 2 handheld controller.

REPLACEMENT BUMPER TRIM KIT

Eliminate the need to cut or modify a portion of the OEM bumper to access the push beam hooks. The replacement bumper trim kit uses factory mounting holes, giving the plow vehicle an attractive, finished OEM look when installed. If the truck is sold without the plow, the original bumper piece can be reinstalled to look like new. (Available for certain Chevy/GMC® models only.)

MAINTENANCE

TOUCH-UP PAINT

Cover chips and scrapes the professional way with BOSS touch-up paint.



GENUINE ICE CONTROL ACCESSORIES

HOPPER SPREADERS



PRE-WET SYSTEM

Equipped with a 60-gallon tank, the pre-wet system allows contractors to pre-wet solid deicing materials as they are distributed. Available on new VBX and FORGE® spreaders. Mounting bracket included.

INVERTED V

Control the weight and flow of materials onto the pintle chain with this optional accessory. Inverted V comes standard on auger spreaders.



BACKUP CAMERA

The spreader backup camera has a 150° viewing angle, 20G vibration rating and IP68 waterproof rating. It is equipped with infrared lights that allow for 50 feet of vision at night as well as a 7" LCD color monitor with backlit buttons.

HOPPER VIBRATOR KIT

Improve material flow and handling with the addition of the Hopper Spreader Vibrator Kit. This kit supports both the VBX and FORGE® model spreaders. (Optional on pintle. Standard on auger systems.)

TGS

TGS VIBRATOR KIT

Improve material flow and handling with the TGS Vibrator Kit. This kit reduces material flow issues and increases your efficiency and profitability. (Not recommended for TGS 300.)

MATERIAL SAVER SYSTEM

Eliminate material flow when the spreader is not in use. Intended for fine deicers that are prone to leaking. (Standard on TGS 300. Optional on TGS 600 and TGS 1100. Not available on TGS 800.)

FORGE®

TARP

Protect spreading material from the elements with a VCP tarp and bungee tie-downs, optional on FORGE® models, standard on VBX models.

WORK LIGHT KIT

Increase visibility of the spreader when plowing at night. The FORGE® work light kit includes two headlights, each with a single 55-watt halogen bulb, and all hardware and wiring to activate lights from inside the cab or at the rear of the spreader.

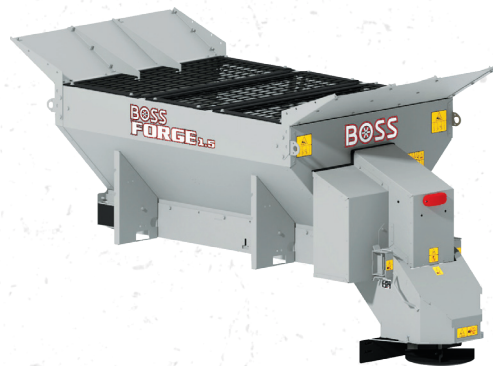

HOPPER SPILL GUARDS

Protect the bed of the truck from salt spills when filling FORGE® 1.0 and 1.5 spreaders. Spill guards widen the top width of the spreader, making loading with loader buckets easier. (Excludes FORGE® 2.0 Long Bed.)

HOPPER EXTENSION KIT

Add additional capacity to your FORGE® spreader by adding a FORGE® Extension Kit. Increase material capacity by a full ½ yard by adding these easy-to-install Stainless Steel Extensions.

TOOLS

SCOOP AND PUSHER SHOVELS

BOSS has joined forces with the leaders in high-performance, contractor-grade snow shovels! These tough, durable, high-performance shovels are built for the abuse of the season with premium blade material for unmatched scraping ability.



5-GALLON BUCKETS AND LIDS

Be ready for the worst weather with 5-gallon buckets that allow you to carry additional supplies to any job site.

WALK-BEHIND SPREADERS

Simply and efficiently spread up to 100 pounds of material with these professional-grade BOSS Walk-Behind Spreaders. Side and front adjustable baffles, weather cover and grate are all included. Both stainless steel and poly hopper options are available.

PROFESSIONAL-USE PLOWS

DXT

VEHICLE APPLICATION: 4WD, ¾- AND 1-TON TRUCKS, MEDIUM-DUTY TRUCKS 14,000-27,000 GVWR (10' ONLY)



Specifications	8'2" DXT Steel / Poly / Stainless	9'2" DXT Steel / Poly / Stainless	10' DXT Steel Heavy-Duty
Blade Width (Straight) Curb Guard Width*	98" (249 cm) 101" (256.5 cm)	110" (279 cm) 113" (287 cm)	120" (305 cm) 123.75" (314.3 cm)
Blade Width (V Position) Curb Guard Width*	88" (224 cm) 88" (224 cm)	100.65" (255.7 cm) 98.5" (250.2 cm)	107" (272 cm) 108" (274.3 cm)
Blade Width (Scoop) Curb Guard Width*	81" (206 cm) 92.9" (235.9 cm)	92" (234 cm) 103.3" (262.4 cm)	102" (259 cm) 111.1" (282.2 cm)
Plowing Width @ 30° Angle	85" (216 cm)	95" (241 cm)	104" (264 cm)
Blade Height	30" (76 cm) at center; 37½" (95 cm) at ends	30" (76 cm) at center; 37½" (95 cm) at ends	35" (89 cm) at center; 45" (114 cm) at ends
Blade Thickness	11-ga steel / ¾" (0.95 cm) poly / 14-ga stainless steel	11-ga steel / ¾" (0.95 cm) poly / 14-ga stainless steel	11-ga steel
Base Angle	½" x 6" (1.3 cm x 15 cm)**	½" x 6" (1.3 cm x 15 cm)**	½" x 6" (1.3 cm x 15 cm)**
Reinforcement Ribs	6 vertical, 2 diagonal	8 vertical, 2 diagonal	8 vertical, 2 diagonal
Plow Shoes	Optional	Optional	Optional
Trip Springs (Moldboard)	4 extension springs	4 extension springs	4 extension springs
Trip Springs (Base Angle)	6 total ½" x 6" AR 400	6 total ½" x 6" AR 400	6 total ½" x 6" AR 400
SmartLock® Cylinders	1½" x 10" (4 cm x 25 cm)	1½" x 10" (4 cm x 25 cm)	2" x 10" (5 cm x 25 cm)
Lift Cylinder	2" x 1½" x 10" (5 cm x 3 cm x 25 cm)	2" x 1½" x 10" (5 cm x 3 cm x 25 cm)	2½" x 1½" x 12" (6.7 cm x 2.9 cm x 30.5 cm)
Attachment System	SmartHitch® 2	SmartHitch® 2	SmartHitch® 2
Plow Weight***	868 lb ^A (394 kg) / 878 lb ^A (398 kg) / 920 lb ^A (417 kg)	925 lb ^A (420 kg) / 935 lb ^A (424 kg) / 977 lb ^A (443 kg)	1,205 lb ^A (547 kg)
Plow Lights	SL3 LED with Ice Shield Technology™	SL3 LED with Ice Shield Technology™	SL3 LED with Ice Shield Technology™
D-Force®	Optional	Optional	N/A

*Maximum product width. **The tripping base angles on the DXT come standard with curb guards and patented snow catcher, and they can be used as the cutting edge until worn. ***Plow weight does not include vehicle mount weight. ^AVehicle mount weight range: 130-160 lb (59-73 kg).

XT

VEHICLE APPLICATION: 4WD, ¾- AND 1-TON TRUCKS



Specifications	7'6" XT Steel	8'2" XT Steel / Poly / Stainless	9'2" XT Steel / Poly / Stainless
Blade Width (Straight) Curb Guard Width*	90" (229 cm) 93.75" (238.1 cm)	98" (249 cm) 101.75" (258.5 cm)	110" (279 cm) 113.75" (288.9 cm)
Plowing Width (V Position) Curb Guard Width*	81" (206 cm) 82.5" (209.6 cm)	88" (224 cm) 89.5" (227.3 cm)	99" (252 cm) 99.9" (253.8 cm)
Plowing Width (Scoop) Curb Guard Width*	74" (188 cm) 86.1" (218.7 cm)	81" (206 cm) 93" (236.2 cm)	92" (234 cm) 103.4" (262.6 cm)
Plowing Width @ 30° Angle	77" (196 cm)	85" (216 cm)	95" (241 cm)
Blade Height	30" (76 cm) at center; 36" (91 cm) at ends	30" (76 cm) at center; 37½" (95 cm) at ends	30" (76 cm) at center; 37½" (95 cm) at ends
Blade Thickness	14-ga steel	11-ga steel / ¾" (0.95 cm) poly / 14-ga stainless steel	11-ga steel / ¾" (0.95 cm) poly / 14-ga stainless steel
Cutting Edge (AR450)	½" x 6" (1.3 cm x 15 cm)	½" x 6" (1.3 cm x 15 cm)	½" x 6" (1.3 cm x 15 cm)
Reinforcement Ribs	6 vertical, 2 diagonal	6 vertical, 2 diagonal	8 vertical, 2 diagonal
Plow Shoes	Optional	Optional	Optional
Trip Springs	4	4	4
SmartLock® Cylinders	1½" x 10" (4 cm x 25 cm)	1½" x 10" (4 cm x 25 cm)	2" x 10" (5 cm x 25 cm)
Lift Cylinder	2" x 1½" x 10" (5 cm x 3 cm x 25 cm)	2" x 1½" x 10" (5 cm x 3 cm x 25 cm)	2" x 1½" x 10" (5 cm x 3 cm x 25 cm)
Attachment System	SmartHitch® 2	SmartHitch® 2	SmartHitch® 2
Plow Weight**	713 lb ^B (323 kg)	785 lb ^B (356 kg) / 795 lb ^B (361 kg) / 823 lb ^B (374 kg)	842 lb ^B (382 kg) / 852 lb ^B (387 kg) / 882 lb ^B (400 kg)
Plow Lights	SL3 LED with Ice Shield Technology™	SL3 LED with Ice Shield Technology™	SL3 LED with Ice Shield Technology™

*Maximum product width. **Plow weight does not include vehicle mount weight. ^BVehicle mount weight range: 75-105 lb (34-48 kg).

PERSONAL-USE PLOWS

HTX V-BLADES AND STRAIGHT-BLADES

VEHICLE APPLICATION: LIGHT-DUTY, 4WD, ½- AND ¾-TON TRUCKS AND SUVs



Specifications	7'6" HTX V-Plow Steel	7' HTX Straight Steel / Poly / Stainless	7'6" HTX Straight Steel / Poly / Stainless
Blade Width (Straight) Curb Guard Width*	90" (229 cm) 94.2" (239.2 cm)	84" (213 cm) N/A	90" (229 cm) N/A
Plowing Width (V Position) Curb Guard Width*	81" (206 cm) 82.75" (210.2 cm)	N/A	N/A
Plowing Width (Scoop) Curb Guard Width*	74" (188 cm) 86.75" (220.4 cm)	N/A	N/A
Plowing Width @ 30° Angle	78" (198 cm)	73" (185 cm)	78" (198 cm)
Blade Height	32" (81 cm) at end; 25" (64 cm) at center	26" (66 cm)	26" (66 cm)
Blade Thickness	14-ga steel	14-ga (0.19 cm) steel / ¼" (0.6 cm) poly / 14-ga (0.19 cm) stainless steel	14-ga (0.19 cm) steel / ¼" (0.6 cm) poly / 14-ga (0.19 cm) stainless steel
Cutting Edge	¾" x 6" (0.95 cm x 15 cm) (AR450)	¾" x 6" (0.95 cm x 15 cm)	¾" x 6" (0.95 cm x 15 cm)
Reinforcement Ribs	6 vertical, 2 diagonal	4 vertical, 2 diagonal	6 vertical, 2 diagonal
Plow Shoes	Optional	Optional	Optional
Trip Springs	2	2	2
SmartLock® Cylinders	1¼" x 8¼" (3 cm x 21 cm)	N/A	N/A
Angle Cylinders	N/A	1½" x 6½" (4 cm x 17 cm)	1½" x 6½" (4 cm x 17 cm)
Lift Cylinder	1¾" x 1½" x 10" (5 cm x 3 cm x 25 cm)	1¾" x 1½" x 10" (5 cm x 3 cm x 25 cm)	1¾" x 1½" x 10" (5 cm x 3 cm x 25 cm)
Attachment System	SmartHitch® 2	SmartHitch® 2	SmartHitch® 2
Plow Weight**	490 lb ^c (222 kg)	393 lb ^c (178 kg) / 367 lb ^c (167 kg) / 393 lb ^c (178 kg)	440 lb ^c (200 kg) / 416 lb ^c (189 kg) / 440 lb ^c (200 kg)
Plow Lights	SL3 LED with Ice Shield Technology™	SL3 LED with Ice Shield Technology™	SL3 LED with Ice Shield Technology™
D-Force®	N/A	Optional	Optional

*Maximum product width. **Plow weight does not include vehicle mount weight. ^cVehicle mount weight range: 45-75 lb (20-34 kg).

PROFESSIONAL-USE PLOWS

DRAG PRO®

VEHICLE APPLICATION: 4WD, ¾- TO 1-TON TRUCKS



Specifications	8' Fixed Wing	8'-12' Hydraulic Folding Wing	8'-16' Hydraulic Folding Wing
Blade Width (Folded)	96" (244 cm)	96" (244 cm)	96" (244 cm)
Blade Width (Extended)	N/A	144" (366 cm)	192" (488 cm)
Plow Weight*	780 lb ^b (354 kg)	790 lb ^b (358 kg)	890 lb ^b (404 kg)
Moldboard Height	24" (61 cm)	24" (61 cm)	24" (61 cm)
Moldboard Thickness	11-ga steel	11-ga steel	11-ga steel
Moldboard Cutting Edge	½" x 6" (1.3 cm x 15 cm)	½" x 6" (1.3 cm x 15 cm)	½" x 6" (1.3 cm x 15 cm)
Wing Cutting Edges	1½" x 6" (4 cm x 15 cm)	1½" x 6" (4 cm x 15 cm)	1½" x 6" (4 cm x 15 cm)
Wing Cylinders	N/A	2¼" x 1½" x 5½" (6 cm x 3 cm x 13 cm)	2¼" x 1½" x 5½" (6 cm x 3 cm x 13 cm)
Lift Cylinder	2¼" x 1½" x 12" (6 cm x 3 cm x 31 cm)	2¼" x 1½" x 12" (6 cm x 3 cm x 31 cm)	2¼" x 1½" x 12" (6 cm x 3 cm x 31 cm)
Adjustable Raise/Lower Valve	Standard	Standard	Standard

*Plow weight does not include vehicle mount weight. ^bVehicle mount weight range: 75-105 lb (34-48 kg).

PROFESSIONAL-USE PLOWS

EXT

VEHICLE APPLICATION: 4WD, ¾- AND 1-TON TRUCKS



Specifications	8' Retracted / 10' Expanded Steel
Blade Width (Retracted)	96" (244 cm)
Blade Width (Extended)	120" (305 cm)
Plowing Width @ 30° Angle	83" (211 cm) / 103" (262 cm)
Blade Height	30" (76.2 cm)
Blade Thickness	11-ga steel
Cutting Edge (AR450)	½" x 6" (1.3 cm x 15 cm)
Reinforcement Ribs	9 vertical
Plow Shoes	Optional
Trip Springs	4
Angle Cylinders	1½" x 10" (4 cm x 25 cm)
Wing Cylinders	1½" x 1⅞" x 12¾" (4 cm x 3 cm x 32 cm)
Lift Cylinder	2" x 1⅞" x 10" (5 cm x 3 cm x 25 cm)
Shock Absorber	1
Attachment System	SmartHitch® 2
Plow Weight*	970 lb ^B (440 kg)
Plow Lights	SL3 LED with Ice Shield Technology™

*Plow weight does not include vehicle mount weight. ^BVehicle mount weight range: 75-105 lb (34-48 kg).



SUPER-DUTY FULL-TRIP STRAIGHT-BLADE

VEHICLE APPLICATION: 4WD, ¾- TO 1-TON TRUCKS

Specifications	7'6" Super-Duty Steel / Poly	8' Super-Duty Steel / Poly	8'6" Super-Duty Steel	9' Super-Duty Steel
Blade Width (Straight)	90" (229 cm)	96" (244 cm)	102" (259 cm)	108" (274 cm)
Plowing Width @ 30° Angle	78" (198 cm)	83" (211 cm)	88" (224 cm)	93½" (238 cm)
Blade Height	29" (74 cm)	29" (74 cm)	29" (74 cm)	29" (74 cm)
Blade Thickness	11-ga steel / ⅜" (0.95 cm) poly	11-ga steel / ⅜" (0.95 cm) poly	11-ga steel	11-ga steel
Cutting Edge	½" x 6" (1.3 cm x 15 cm)	½" x 6" (1.3 cm x 15 cm)	½" x 6" (1.3 cm x 15 cm)	½" x 6" (1.3 cm x 15 cm)
Reinforcement Ribs	7 vertical, 2 diagonal	7 vertical, 2 diagonal	7 vertical, 2 diagonal	7 vertical, 2 diagonal
Plow Shoes	Cast iron	Cast iron	Cast iron	Cast iron
Trip Springs	4	4	4	4
Angle Cylinders	1½" x 10" (4 cm x 25 cm)	1½" x 10" (4 cm x 25 cm)	1½" x 10" (4 cm x 25 cm)	1½" x 10" (4 cm x 25 cm)
Lift Cylinder	2" x 1⅞" x 10" (5 cm x 3 cm x 25 cm)	2" x 1⅞" x 10" (5 cm x 3 cm x 25 cm)	2" x 1⅞" x 10" (5 cm x 3 cm x 25 cm)	2" x 1⅞" x 10" (5 cm x 3 cm x 25 cm)
Shock Absorber	1	1	1	1
Attachment System	SmartHitch® 2	SmartHitch® 2	SmartHitch® 2	SmartHitch® 2
Plow Weight*	680 lb ^B (308 kg) / 706 lb ^B (320 kg)	698 lb ^B (317 kg) / 722 lb ^B (328 kg)	720 lb ^B (327 kg)	742 lb ^B (337 kg)
Plow Lights	SL3 LED with Ice Shield Technology™	SL3 LED with Ice Shield Technology™	SL3 LED with Ice Shield Technology™	SL3 LED with Ice Shield Technology™
D-Force®	Optional	Optional	Optional	Optional

*Plow weight does not include vehicle mount weight. ^BVehicle mount weight range: 75-105 lb (34-48 kg).

PROFESSIONAL-USE PLOWS

SUPER-DUTY TRIP-EDGE STRAIGHT-BLADE

VEHICLE APPLICATION: 4WD, ¾- TO 1-TON TRUCKS



Specifications	7'6" Trip-Edge Steel	8' Trip-Edge Steel / Stainless	9' Trip-Edge Steel / Stainless
Blade Width (Straight)	90" (229 cm)	96" (244 cm)	108" (274 cm)
Plowing Width @ 30° Angle	78" (198 cm)	83" (211 cm)	93½" (238 cm)
Blade Height	31" (79 cm)	31" (79 cm)	31" (79 cm)
Blade Thickness	11-ga steel	11-ga steel / 14-ga 304 stainless steel	11-ga steel / 14-ga 304 stainless steel
Base Angle	½" x 3½" (1.3 cm x 9 cm)	½" x 3½" (1.3 cm x 9 cm)	½" x 3½" (1.3 cm x 9 cm)
Cutting Edge	½" x 6" (1.3 cm x 15 cm)	½" x 6" (1.3 cm x 15 cm)	½" x 6" (1.3 cm x 15 cm)
Reinforcement Ribs	6 vertical, 2 diagonal	6 vertical, 2 diagonal	8 vertical, 2 diagonal
Plow Shoes	Cast iron	Cast iron	Cast iron
Trip Springs	4	4	4
Trip Pivot Pin Diameter	1" (3 cm)	1" (3 cm)	1" (3 cm)
Trip Spring Type	¾" (0.95 cm) hooked extension spring	¾" (0.95 cm) hooked extension spring	¾" (0.95 cm) hooked extension spring
Trip-Edge Adjustable	Standard	Standard	Standard
Angle Cylinders	1½" x 10" (4 cm x 25 cm)	1½" x 10" (4 cm x 25 cm)	1½" x 10" (4 cm x 25 cm)
Lift Cylinder	2" x 1½" x 10" (5 cm x 3 cm x 25 cm)	2" x 1½" x 10" (5 cm x 3 cm x 25 cm)	2" x 1½" x 10" (5 cm x 3 cm x 25 cm)
Attachment System	SmartHitch® 2	SmartHitch® 2	SmartHitch® 2
Plow Weight*	796 lb ⁸ (361 kg)	825 lb ⁸ (374 kg) / 875 lb ⁸ (397 kg)	877 lb ⁸ (398 kg) / 934 lb ⁸ (424 kg)
Plow Lights	SL3 LED with Ice Shield Technology™	SL3 LED with Ice Shield Technology™	SL3 LED with Ice Shield Technology™

*Plow weight does not include vehicle mount weight. ⁸Vehicle mount weight range: 75-105 lb (34-48 kg).

HEAVY-DUTY PLOWS

HEAVY-DUTY STRAIGHT-BLADE

VEHICLE APPLICATION: MEDIUM-DUTY TRUCKS, 14,000-27,000 GVWR

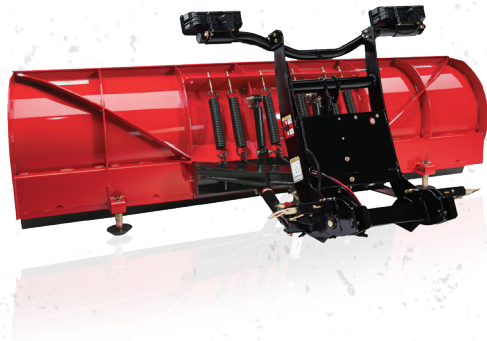

Specifications	9' Heavy-Duty Steel	10' Heavy-Duty Steel
Blade Width (Straight)	108" (274 cm)	120" (305 cm)
Plowing Width @ 30° Angle	94" (239 cm)	104" (264 cm)
Blade Height	34½" (88 cm)	34½" (88 cm)
Blade Thickness	7-ga steel	7-ga steel
Cutting Edge	½" x 6" (1.3 cm x 15 cm)	½" x 6" (1.3 cm x 15 cm)
Reinforcement Ribs	8 vertical, 2 diagonal	8 vertical, 2 diagonal
Plow Shoes	Cast iron	Cast iron
Trip Springs	6	6
Angle Cylinders	2" x 10" (5 cm x 25 cm)	2" x 10" (5 cm x 25 cm)
Lift Cylinder	2¼" x 1½" x 12" (6 cm x 3 cm x 31 cm)	2¼" x 1½" x 12" (6 cm x 3 cm x 31 cm)
Shock Absorber	2	2
Attachment System	SmartHitch® 2	SmartHitch® 2
Plow Weight*	1,152 lb ^A (523 kg)	1,205 lb ^A (547 kg)
Plow Lights	SL3 LED with Ice Shield Technology™	SL3 LED with Ice Shield Technology™

*Plow weight does not include vehicle mount weight. ^AVehicle mount weight range: 130-160 lb (59-73 kg).

ICE CONTROL EQUIPMENT

VBX HOPPER SPREADERS

VEHICLE APPLICATION: ¾- TO 1-TON TRUCKS, DUMP BODY AND FLATBED TRUCKS



Specifications	VBX 6500 Auger / Pintle Chain	VBX 8000 Auger / Pintle Chain	VBX 9000 Auger / Pintle Chain
Hopper Capacity	1.5 cu yd (1.15 cu m)	2 cu yd (1.5 cu m)	3 cu yd (2.3 cu m)
Hopper Length	78" (198 cm)	96" (244 cm)	108" (274 cm)
Overall Length	93½" (237.5 cm)	112" (284.5 cm)	122" (310 cm)
Hopper Height	38" (96.5 cm)	38" (96.5 cm)	49" (124.5 cm)
Hopper Width	48¼" (123 cm)	48¼" (123 cm)	48" (122 cm)
Complete Unit Weight (Empty)	550 lb (250 kg) / 600 lb (272 kg)	600 lb (272 kg) / 650 lb (295 kg)	710 lb (322 kg) / 760 lb (345 kg)
Hopper Construction	¾" (0.5 cm) double wall polyethylene hopper	¾" (0.5 cm) double wall polyethylene hopper	¾" (0.5 cm) double wall polyethylene hopper
Spreading Width	2' - 40' (0.6 m - 12.2 m) dry, free-flowing material	2' - 40' (0.6 m - 12.2 m) dry, free-flowing material	2' - 40' (0.6 m - 12.2 m) dry, free-flowing material
Max Feed Rate	2.3 cu ft (0.07 cu m) per minute / 4 cu ft (0.11 cu m) per minute	2.3 cu ft (0.07 cu m) per minute / 4 cu ft (0.11 cu m) per minute	2.3 cu ft (0.07 cu m) per minute / 4 cu ft (0.11 cu m) per minute
Lighting	Dual 55-watt halogen variable output worklights	Dual 55-watt halogen variable output worklights	Dual 55-watt halogen variable output worklights
Cover	VCP tarp w/integrated tie-downs	VCP tarp w/integrated tie-downs	VCP tarp w/integrated tie-downs
Top Screen	Standard	Standard	Standard
Gearbox Ratio	Planetary 91:1 / 137:1	Planetary 91:1 / 137:1	Planetary 91:1 / 137:1
Motor	¾ hp stainless steel feed motor	¾ hp stainless steel feed motor	¾ hp stainless steel feed motor
Trough	11-ga stainless steel	11-ga stainless steel	11-ga stainless steel
Dual Variable Speed Control	Standard with LCD display	Standard with LCD display	Standard with LCD display
Variable Speed Vibrator	200 lb (90.7 kg) 2 standard (auger) / optional (pintle)	200 lb (90.7 kg) 2 standard (auger) / optional (pintle)	200 lb (90.7 kg) 2 standard (auger) / optional (pintle)
Inverted V-Baffle	Standard / optional	Standard / optional	Standard / optional
Feed System	6" OD x 9" (15 cm x 23 cm) pitch full-length auger / 14" (36 cm) wide pintle chain	6" OD x 9" (15 cm x 23 cm) pitch full-length auger / 14" (36 cm) wide pintle chain	6" OD x 9" (15 cm x 23 cm) pitch full-length auger / 14" (36 cm) wide pintle chain
LED CHMSL	Standard	Standard	Standard
Adjustable Deflector	Standard	Standard	Standard
Spinner Assembly	Easily removable; swing out; height-adjustable	Easily removable; swing out; height-adjustable	Easily removable; swing out; height-adjustable
Hopper Tie-Down Kit	Standard	Standard	Standard
Spinner	14½" (36.8 cm) diameter urethane	14½" (36.8 cm) diameter urethane	14½" (36.8 cm) diameter urethane
Spinner Gearmotor	½ hp spinner gearmotor (located above spinner)	½ hp spinner gearmotor (located above spinner)	½ hp spinner gearmotor (located above spinner)
Minimum Bed Length	66" (168 cm)	78" (198 cm)	96" (244 cm)
Vehicle Application	¾- to 1-ton trucks	1-ton trucks and up	Dump body and flatbed with 13,000 GVWR and up

See Spreader Materials Guide on Page 30 for more details on material spreading options.

ICE CONTROL EQUIPMENT

FORGE® HOPPER SPREADERS

VEHICLE APPLICATION: ½- TO 1-TON TRUCKS, DUMP BODY AND FLATBED TRUCKS



Specifications	FORGE® 1.0 Auger / Pintle Chain	FORGE® 1.5 Auger / Pintle Chain	FORGE® 2.0 Long Bed Auger / Pintle Chain
Hopper Capacity	1 cu yd (0.76 cu m)	1.5 cu yd (1.15 cu m)	2 cu yd (1.5 cu m)
Hopper Length	49.5" (126 cm)	70" (177.8 cm)	96" (243.8 cm)
Overall Length	78" (198 cm)	98" (249 cm)	124" (315 cm)
Hopper Height	33" (84 cm)	33" (84 cm)	36" (91.4 cm)
Hopper Width	48" (122 cm)	48" (122 cm)	48" (122 cm)
Complete Unit Weight (Empty)	575 lb (261 kg) / 625 lb (284 kg)	700 lb (318 kg) / 750 lb (340 kg)	775 lb (351.5 kg) / 825 lb (374.2 kg)
Hopper Construction	14-ga stainless steel	14-ga stainless steel	14-ga stainless steel
Spreading Width	2' - 40' (0.6 m - 12.2 m) dry, free-flowing material	2' - 40' (0.6 m - 12.2 m) dry, free-flowing material	2' - 40' (0.6 m - 12.2 m) dry, free-flowing material
Max Feed Rate	2.3 cu ft (0.07 cu m) per minute / 4 cu ft (0.11 cu m) per minute	2.3 cu ft (0.07 cu m) per minute / 4 cu ft (0.11 cu m) per minute	2.3 cu ft (0.07 cu m) per minute / 4 cu ft (0.11 cu m) per minute
Lighting	Optional	Optional	Optional
Cover	Optional	Optional	Optional
Top Screen	Standard	Standard	Standard
Gearbox Ratio	Planetary 91:1 / 137:1	Planetary 91:1 / 137:1	Planetary 91:1 / 137:1
Motor	½ hp motor	½ hp motor	½ hp motor
Trough	11-ga stainless steel	11-ga stainless steel	11-ga stainless steel
Dual Variable Speed Control	Standard / optional	Standard / optional	Standard / optional
Vibrator	200 lb (90.7 kg) 1 standard (auger) / optional (pintle)	200 lb (90.7 kg) 1 standard (auger) / optional (pintle)	200 lb (90.7 kg) 1 standard (auger) / optional (pintle)
Inverted V-Baffle	Standard / optional	Standard / optional	Standard / optional
Feed System	6" OD X 9" (15 cm x 23 cm) pitch full-length auger / 14" (36 cm) wide pintle chain	6" OD X 9" (15 cm x 23 cm) pitch full-length auger / 14" (36 cm) wide pintle chain	6" OD X 9" (15 cm x 23 cm) pitch full-length auger / 14" (36 cm) wide pintle chain
LED CHMSL	Standard	Standard	Standard
Adjustable Deflector	Standard	Standard	Standard
Spinner Assembly	Easily removable; swing out	Easily removable; swing out	Easily removable; swing out
Hopper Tie-Down Kit	Standard	Standard	Standard
Spinner	14½" (36.8 cm) diameter urethane	14½" (36.8 cm) diameter urethane	14½" (36.8 cm) diameter urethane
Spinner Gearmotor	½ hp gearmotor (located above spinner)	½ hp gearmotor (located above spinner)	½ hp gearmotor (located above spinner)
Minimum Bed Length	66" (168 cm)	78" (198 cm)	96" (243.8 cm)
Vehicle Application	½-ton trucks	¾- to 1-ton trucks	1-ton trucks and up

See Spreader Materials Guide on Page 30 for more details on material spreading options.

ICE CONTROL EQUIPMENT

TGS TAILGATE SPREADERS

VEHICLE APPLICATION: SUVs AND ½- TO 1-TON TRUCKS



Specifications	TGS 300*	TGS 600*	TGS 800**	TGS 1100*
Hopper Design	Low-profile	Low-profile	Low-profile	Low-profile
Hopper Construction	Polyethylene	Polyethylene	Polyethylene	Polyethylene
Hopper Capacity Limit***	3 cu ft / 200 lb (0.09 cu m / 91 kg)	6 cu ft / 400 lb (0.17 cu m / 181 kg)	8 cu ft / 780 lb (0.23 cu m / 354 kg)	11 cu ft / 800 lb (0.31 cu m / 363 kg)
Hopper Dimensions	21½"H x 29"W x 15"D (56 cm x 74 cm x 38 cm)	25¾"H x 38"W x 21"D (65 cm x 97 cm x 53 cm)	48"H x 36"W x 21"D (122 cm x 91 cm x 53 cm)	34"H x 44"W x 24"D (86 cm x 112 cm x 61 cm)
Spreader Weight	70 lb (32 kg) plus mount	101 lb (46 kg) plus mount	220 lb (100 kg) plus mount	152 lb (69 kg) plus mount
Hopper Cover	Polyethylene	Polyethylene	Polyethylene	Polyethylene
Feed Mechanism	Internal auger with material saving brush	Internal auger with cable-link agitator and adjustable feed gate	Feed paddle and adjustable feed gate	Internal auger with cable-link agitator and adjustable feed gate
Vibrator Kit	Not recommended	Optional	Optional	Optional
Top Screen With Bag Splitter	Top screen only	Standard, top screen with bag splitter	Standard, top screen with bag splitter	Standard, top screen with bag splitter
Motor	High-torque / 12-volt DC	High-torque / 12-volt DC	(2) High-torque / 12-volt DC	High-torque / 12-volt DC
Spinner	12" (31 cm) diameter polyurethane	12" (31 cm) diameter polyurethane	12" (31 cm) diameter polyurethane	12" (31 cm) diameter polyurethane
Spreading Width	4' - 30' (1 - 9 m)	4' - 30' (1 - 9 m)	4' - 20' (1 - 6 m)	4' - 30' (1 - 9 m)
Material Deflector	Adjustable poly deflector	Adjustable poly deflector	Adjustable poly deflector	Adjustable poly deflector
Receiver Class Hitch	Class 2-4	Class 3 or 4	Class 4	Class 4
Control	Variable speed control with LED digital display is equipped with blast feature and overload protection	Variable speed control with LED digital display is equipped with blast feature and overload protection	Independent variable speed control for material feed and spinner with blast feature and overflow protection	Variable speed control with LED digital display is equipped with blast feature and overload protection
Vehicle Applications	SUV, light truck and up	½ to 1-ton trucks	¾- and 1-ton trucks	¾- and 1-ton trucks

*Designed to spread dry, free-flowing material (i.e., salt, deicers, etc.). **Designed to spread sand, salt or a combination of both. See Spreader Materials Guide on Page 30 for more details on material spreading options.

***Capacity weight max.

All images shown may include standard/optional equipment. Please consult your local BOSS Dealer for more information.

TWO-YEAR LIMITED WARRANTY

All BOSS snowplows and equipment are guaranteed to be free from defects in material and workmanship for two full years from the date of purchase. Stop by any authorized BOSS Dealer to receive complete details on our two-year parts and labor warranty. Please visit bossplow.com for more details.

LEGAL STATEMENT

Vehicles intended to be equipped with a spreader and/or snowplow must comply with the vehicle manufacturers' specifications for equipment application. BOSS Products reserves the right under its product improvement policy to change construction or design details and furnish equipment when so altered without reference to illustrations or specifications used herein. BOSS Products may be protected by one or more patents; please see bossplow.com for more details.

To comply with federal regulations and to ensure a safe vehicle, do not exceed the front gross axle weight rating (FGAWR), rear gross axle weight rating (RGAWR), gross vehicle weight rating (GVWR) or maximum vehicle payload ratings at any time. Combinations of equipment such as snowplows and spreaders, density of material being spread and the number of vehicle occupants should be taken into consideration. Ensuring these limitations are not exceeded may require weighing the vehicle and adding ballast as necessary. For receiver hitch-mounted products, do not exceed hitch rating at any time. Completed vehicle must not exceed front GAWR or GVWR.

SPREADER MATERIAL GUIDE

Bag Deicers 1 - 4

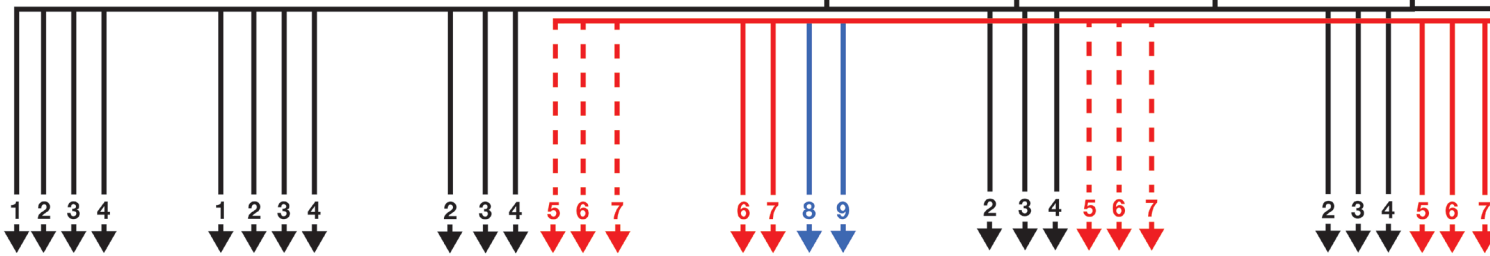
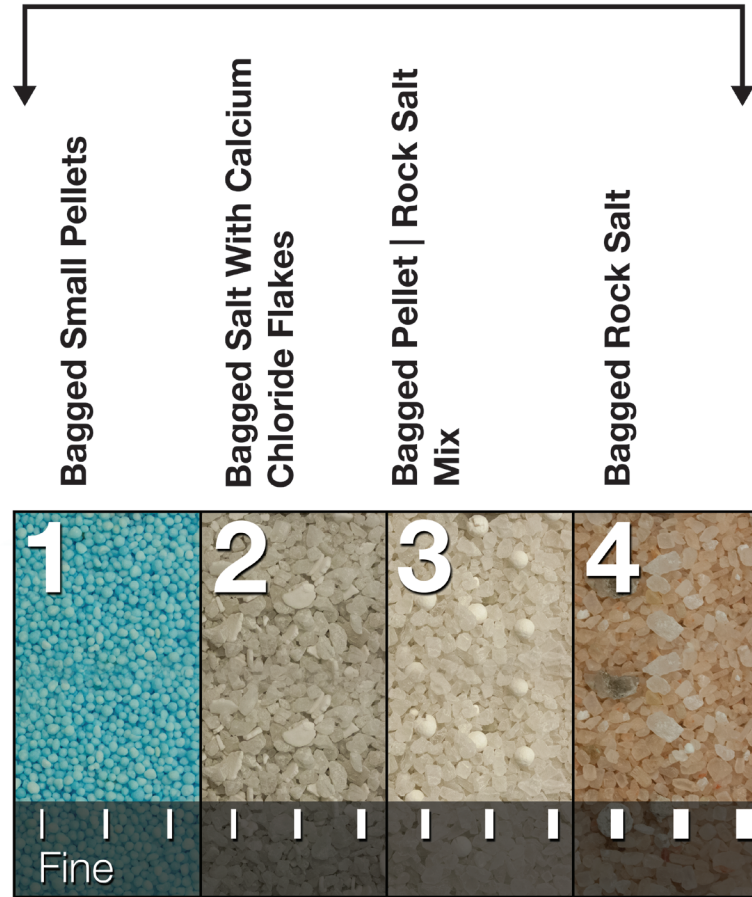

Walk-Behind Spreader



TGS 300



TGS 600



TGS 800



TGS 1100



QuickCube®

NOTE: Assumes Dry, Free-Flowing Material

Bulk Salt 5 - 7

Sand/Salt & Sand 8 & 9

Materials that require a vibrator are indicated by a dashed line.

Fine Bulk Salt

Coarse Bulk Salt

Very Coarse Bulk Salt

Sand/Salt Mix

Sand

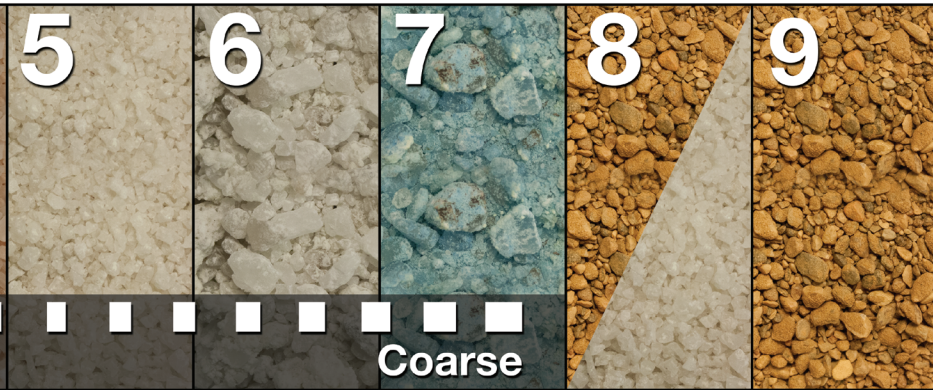

1 2 3 4 5 6 7

5 6 7 8

5 6 7 8 9

5 6 7 8

5 6 7 8 9

AUGER

PINTLE

AUGER

PINTLE



EXACT PATH®



FORGE® 1.0
FORGE® 1.5
FORGE® 2.0 LONG BED



VBX 3000
(Auger Only)

VBX 6500
VBX 8000
VBX 9000



BOSSPLOW.COM

See how BOSS continues to BACK YOU UP.
Get more info, watch videos, find a dealer or chat live.

Call 800-286-4155
Email sales@bossplow.com



With quality and reliability at the forefront, BOSS Genuine Parts are designed, built and tested to fit your BOSS product.



SnowCare for Troops is a nationwide outreach program that performs free snow removal for active military families.



Ask your dealer or visit bossplow.com to explore the complete lineup of BOSS products, including Truck Equipment, Compact Vehicle Equipment, Heavy Equipment, Ice Control Equipment, Snowrator® and Accessories. **Ask your local dealer about financing options!**



Exclusive to BOSS Owners, joining this community gives you a profile page, a free gift and access to special offers and information on BOSS products and services.

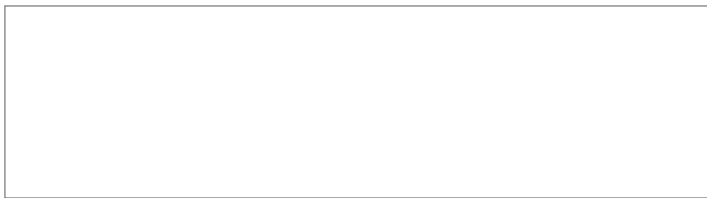

BOSS PRODUCTS
2010 THE BOSS WAY
P.O. BOX 787
IRON MOUNTAIN, MI 49801-0787

BOSS SNOWPLOW PRODUCTS
ARE DESIGNED AND MANUFACTURED IN
AN APPROVED ISO 9001:2015
REGISTERED FACILITY.

PATENTS: www.ttcopats.com
©2020 BOSS PRODUCTS. ALL RIGHTS RESERVED.
PRINTED IN U.S.A. FORM #SLS-TRK02020

GMC is a registered trademark of General Motors LLC. The "f" logo is a registered trademark/service mark of Facebook, Inc. The Instagram logo is a registered service mark of Instagram, LLC. The Twitter logo is a registered trademark/service mark of Twitter, Inc. The YouTube logo is a trademark/service mark of Google LLC. The "in" logo is a registered service mark of LinkedIn Corporation. The Blogger logo is a registered service mark of Google LLC. The Omnia Partners logo is a registered service mark of Omnia Partners, Inc. The Sourcewell logo is a service mark of National Joint Powers Alliance. The Advantage International Registrar logo is a trademark of Advantage International Registrar, Inc. All other trademarks belong to BOSS Snowplow.



OMNIA
PARTNERS

